

Professionall

Solutii profesionale pentru echipamente profesionale



GAS COMPONENTS



ELECTRIC COMPONENTS



WATER TECHNOLOGY



MECHANICAL COMPONENTS



TOOLS

Spare parts suitable for

TECNO MCM



heating elements

heating elements for chicken rotisseries



1 			
No.	416856	Ref. No.	030137E
description	heating element 1100W 230V thread M4 L 864mm W 35mm H 44mm heating circuits 1 connection M4 dry heating element tube ø 10mm connection length 20mm		

1 			
No.	416857	Ref. No.	030120-E 030138-1
description	heating element 4800W 230V 2 hole fixing thread M14x1.25 L 860mm W 130mm H 42mm heating circuits 1 connection M5 dry heating element tube ø 10mm mounting distance 120mm for chicken rotisserie		

switches and momentary switches

rocker/momentary rocker switches

30x22mm

1 			
No.	301001	Ref. No.	06004
description	rocker switch mounting measurements 30x22mm red 2NO 250V 16A illuminated 0-I connection male faston 6.3mm ambient temperature max. 125/55°C protection IP65		
accessories for	301001		
1 			
No.	301036	Ref. No.	—
description	protective cover internal size 30x22mm for rocker switch mounting measurementsmm		

cam switches

on/off

1 			
No.	300017	Ref. No.	030138E
description	cam switch 4 operating positions 4NO sequence 0-1-0-1 16A shaft ø 6x4.6mm shaft L 23mm connection male faston 6.3mm ceramic		

transformers

miscellaneous

1			
No.	400696	Ref. No.	020119
description	transformer		

motors

gear motors

for grills

1 			
No.	601126	Ref. No.	020112
description	gear motor 230V 50Hz 4.5rpm shaft ø 9x10mm L 120mm W 81mm H 66mm for chicken rotisserie type K80640 KELVIN		

1 			
No.	601127	Ref. No.	020118
description	gear motor 24V for chicken rotisserie		

motors

universal

1 			
No.	500625	Ref. No.	140020
description	motor 60W 230V 50Hz 1 phase shaft ø 9mm flange ø 80mm 820rpm type 156C6 ø 110mm H 150mm L 170mm GMS 6-pole 0.06kW		



gas taps

COPRECI

CAL-3200



1

No.	109097	Ref. No.	150015
description	gas tap COPRECI type CAL-3200 gas inlet M20x1.5 (tube ø 12mm) bypass nozzle ø 0.5mm gas outlet M20x1.5 (tube ø 12/10mm) thermocouple connection M9x1 pilot connection shaft ø 8x6.5mm shaft flat right shaft L 29/12mm with pipe outlet		
spare parts for	109097		
	No.	106173	Ref. No.
			—
	magnet unit L 43mm D1 ø 19mm D2 ø 15.5mm suitable for COPRECI		
accessories for	109097		
	No.	101273	Ref. No.
			—
	olive for pipe ø 12mm L 9.5mm brass Qty 1 pcs suitable for universal		

CAL-5200



1



No.	107165	Ref. No.	030151
description	gas tap COPRECI type CAL-5200 gas inlet pipe flange ø21mm bypass nozzle ø 1mm gas outlet M16x1.25 (tube ø 6mm) thermocouple connection M8x1 pilot connection shaft ø 8x6.5mm shaft L 27/12mm shaft flat left		





STN3R



1

No.	101988	Ref. No.	150015-P
description	gas tap STN3R gas inlet M20x1.5 (tube ø 12mm) bypass nozzle ø 0mm gas outlet M20x1.5 (tube ø 12mm) thermocouple connection M9x1 pilot connection closed shaft ø 8x6mm shaft L 24/16.5mm shaft flat lower with pipe outlet suitable for TECNO MCM		
spare parts for	101988		
	No.	101058	Ref. No.
			—
	magnet unit L 39mm D1 ø 15.4mm D2 ø 13.5mm suitable for PEL22/ EGA24197 standard		

accessories for	101988		
	No.	101251	Ref. No.
			—
	union nut thread M20x1.5 for pipe ø 12mm		
	No.	101273	Ref. No.
			—
	olive for pipe ø 12mm L 9.5mm brass Qty 1 pcs suitable for universal		





	No.	101962	Ref. No.	030112
description	gas tap STN3R gas inlet pipe flange bypass nozzle ø 0mm gas outlet M16x1.25 thermocouple connection M8x1 shaft ø 8x6.5mm shaft L 28/14mm shaft flat left suitable for TECNO MCM pipe outlet ø edge-flangemm			
spare parts for	101962			
	No.	101051	Ref. No.	—
				—
	magnet unit L 27mm D1 ø 12.5mm D2 ø 8.5mm suitable for JUNKERS/EGA/MADEC/SABAF standard			
accessories for	101962			
	No.	101376	Ref. No.	—
				—
	gasket ID ø 8mm ED ø 12mm H 3/5mm			
	No.	101964	Ref. No.	030113
				—
	clamping bracket			

MP

gas taps



1

No.	106175	Ref. No.	030150
description	gas tap MP		
accessories for	106175		
	No.	101376	Ref. No.
			—
	gasket ID ø 8mm ED ø 12mm H 3/5mm		
	No.	101964	Ref. No.
			030113
	clamping bracket		
	No.	111647	Ref. No.
			030132
	knob switch zero mark ø 65mm shaft ø 8x6.5mm shaft flat lower black		
	No.	560085	Ref. No.
			—
	hexagonal screw thread M5 thread L 20mm SS WS 8 Qty 20 pcs DIN 933 / ISO 4017		



ignition parts

thermocouples

threaded thermocouples

threaded thermocouples standard

with socket with thread M8x1

SIT

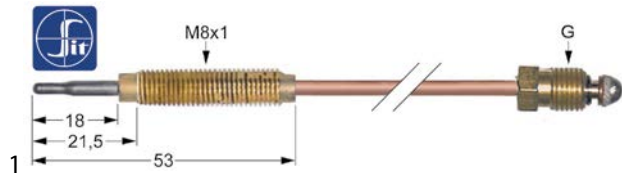

No.	107628	Ref. No.	030115
description	thermocouple SIT M8x1 L 320mm M8x1		
accessories for	107628		
	No.	102067	Ref. No.
			—
	nut thread M8x1 H 3mm brass Qty 1 pcs type SEF 1		

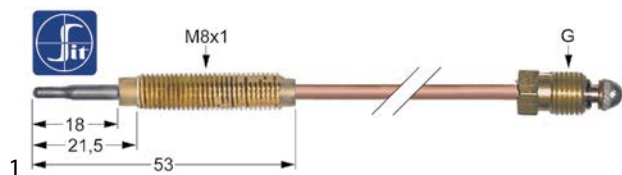



No.	107636	Ref. No.	150016
description	thermocouple SIT M9x1 L 600mm M8x1		
accessories for	107636		
	No.	102067	Ref. No.
			—
	nut thread M8x1 H 3mm brass Qty 1 pcs type SEF 1		



gas burners

ceramic burners



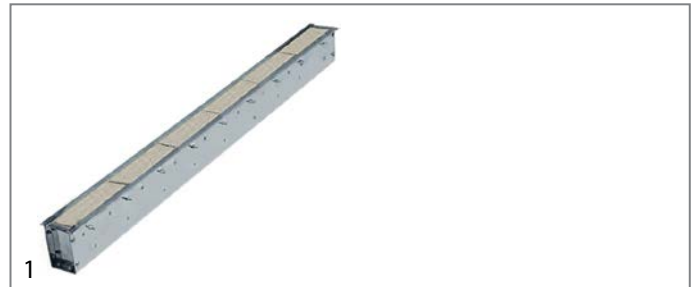



No.	104596	Ref. No.	150000
description	ceramic burner L 1090mm W 80mm firing range 1060x65mm 10400W		
spare parts for	104596		
	No.	104459	Ref. No.
			030009 (1100mm)
	sealing strip L 1090mm W 10mm thickness 4mm ceramic fibre		
	No.	104597	Ref. No.
			23030
	ceramic plate L 102mm W 72mm H 13mm		

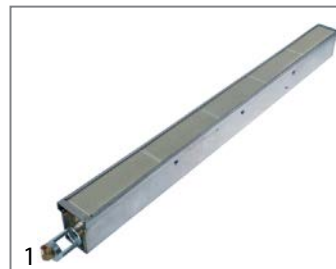

No.	107566	Ref. No.	030001 old
description	ceramic burner L 900mm W 55mm 5300W with 6 ceramic plates edition until year of construction 2005 for chicken rotisserie		
spare parts for	107566		
	No.	104594	Ref. No.
			030102
	ceramic plate L 144mm W 47mm H 13mm		
	No.	104595	Ref. No.
			030009 (900mm)
	sealing strip L 900mm W 10mm thickness 4mm ceramic fibre		



No.	105585	Ref. No.	030001
description	ceramic burner L 900mm W 67mm firing range 875x52mm 5300W with 5 ceramic plates edition since year of construction 2006 for chicken rotisserie		
spare parts for	105585		
	No.	104595	Ref. No.
			030009 (900mm)
	sealing strip L 900mm W 10mm thickness 4mm ceramic fibre		
	No.	106664	Ref. No.
			030119
	gas injector thread M8x1 WS 10 bore ø 1.2mm		
	No.	107567	Ref. No.
			030054-1
	ceramic plate L 173mm W 60mm		
	No.	107861	Ref. No.
			030118
	gas injector thread M8x1 WS 10 bore ø 1.9mm		

accessories

sealing strips

No.	104458	Ref. No.	030009
description	sealing strip L 10000mm W 10mm thickness 4mm ceramic fibre Qty 10m		

No.	104459	Ref. No.	030009 (1100mm)
description	sealing strip L 1090mm W 10mm thickness 4mm ceramic fibre		

1 

No.	104595	Ref. No.	030009 (900mm)
description	sealing strip L 900mm W 10mm thickness 4mm ceramic fibre		

ceramic plates

1 

No.	104597	Ref. No.	23030
description	ceramic plate L 102mm W 72mm H 13mm		

1 

No.	104594	Ref. No.	030102
description	ceramic plate L 144mm W 47mm H 13mm		

1 

No.	107567	Ref. No.	030054-1
description	ceramic plate L 173mm W 60mm		

gas nozzles

main nozzles

gas nozzles M8x1

1 

No.	106664	Ref. No.	030119
description	gas injector thread M8x1 WS 10 bore ø 1.2mm		
For models:	2EG		

1 

No.	107861	Ref. No.	030118
description	gas injector thread M8x1 WS 10 bore ø 1.9mm		

auxiliary gas parts

screw connections

olives

1 

No.	102959	Ref. No.	030133
description	screw connection for pipe ø 8mm Qty 1 pcs thread M12x1		

equipment-specific units

for grills

glass panels

1 

No.	693164	Ref. No.	040805
description	glass panel		

1

No.	693163	Ref. No.	040605
description	glass panel L 1160mm W 462mm for chicken rotisserie for model 6EE, 6EG, 6EEN, 6EEND		



1



No.	693153	Ref. No.	040405
description	glass panel L 799mm W 462mm thickness 5mm rectangular		

skewers

1



No.	693255	Ref. No.	160000
description	skewer		

spit clamp

1



No.	693258	Ref. No.	160015
description	clamp		

1



No.	693256	Ref. No.	160014
description	skewer clamp		

doors

1



No.	693259	Ref. No.	131000
description	glass door		

1



No.	693260	Ref. No.	130000
description	glass door		

for chicken rotisserie

motors

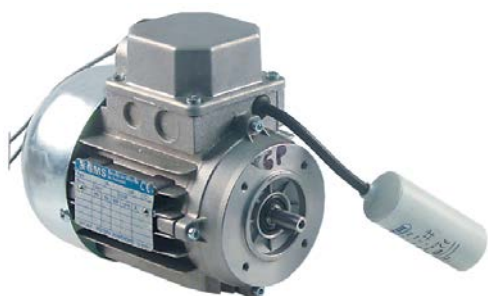

1	No.	500625	Ref. No.	140020
description motor 60W 230V 50Hz 1 phase shaft ø 9mm flange ø 80mm 820rpm type 156C6 ø 110mm H 150mm L 170mm GMS 6-pole 0.06kW				

skewers

1	No.	693141	Ref. No.	0500001
description skewer				

1	No.	693254	Ref. No.	050002
description skewer complete for chicken rotisserie L 900mm thickness 12x12mm				

spit clamp

1	No.	693143	Ref. No.	050110
description skewer clamp crimping range 13x13mm ² double for skewer 12x12mm mounting pos. inner skewer 2x60mm skewer ø 4mm				

1	No.	693142	Ref. No.	050107
description skewer clamp single for skewer 12x12mm mounting pos. outer skewer 75mm skewer ø 4mm				
accessories for 693142				
	No.	697481	Ref. No.	—
Thumb screw thread M6 thread L 8mm ø 14mm H 6mm SS				

miscellaneous

1	No.	693145	Ref. No.	050112
description cylindrical handle thread M10 ø 27mm L 101mm				

1	No.	693146	Ref. No.	050114
description handle draw-off				

1	No.	693144	Ref. No.	050116
description screw for skewer				

for tilting bratt pans

1	No.	523510	Ref. No.	020105
description deep-groove ball bearing type 6202-2RS shaft ø 15mm ED ø 35mm W 11mm with sealing discs deep-groove ball bearing DIN 625-1				

for ovens

1	No.	693149	Ref. No.	040305
description glass panel				





1

No.	693148	Ref. No.	040205
description	glass panel L 463mm W 439mm thickness 5mm rectangular		

for pizza ovens

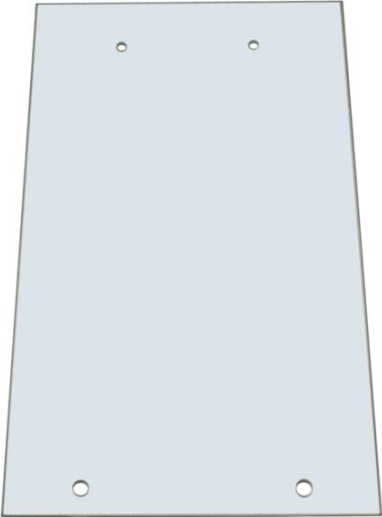
glass panels



1

No.	693147	Ref. No.	040105
description	glass panel		

knobs

producer-specific knobs

TECNO-MCM



1

No.	111647	Ref. No.	030132
description	knob switch zero mark \varnothing 65mm shaft \varnothing 8x6.5mm shaft flat lower black		



1

No.	111648	Ref. No.	H06/NR4 old
description	knob zero mark \varnothing 60mm shaft \varnothing 6x4.6mm shaft flat lower black		



1

No.	111469	Ref. No.	030120-E H06/NR4
description	knob zero mark \varnothing 65mm shaft \varnothing 6x4.6mm shaft flat lower black		

handles and hand wheels

cylindrical handles

fixed



1

No.	693145	Ref. No.	050112
description	cylindrical handle thread M10 \varnothing 27mm L 101mm		

transmission technology and ball bearings

ball bearings

deep-groove ball bearings 2RS



1

No.	523510	Ref. No.	020105
description	deep-groove ball bearing type 6202-2RS shaft \varnothing 15mm ED \varnothing 35mm W 11mm with sealing discs deep-groove ball bearing DIN 625-1		

fastening material

fasteners

retaining rings

DIN 472



1

No.	698003	Ref. No.	020122
description	retaining ring bore \varnothing 35mm thickness 1.5mm steel DIN 472		