

Professionall

Solutii profesionale pentru echipamente profesionale



GAS COMPONENTS



ELECTRIC COMPONENTS



WATER TECHNOLOGY



MECHANICAL COMPONENTS



TOOLS

Spare parts suitable for

STUDIO 54



heating elements

heating elements for refrigeration

heating elements for defrosting



No.	419232	Ref. No.	64740405
description	heating element 150W 230V L 480mm W 60mm tube ø 8.5mm connection length 1450mm defrosting connection 3-wire with fuse t.max. 100°C		

compressors

EMBRACO / ASPERA

R134A

HBP monophase

High evaporation temperature above -15°C



No.	605189	Ref. No.	64850046
description	compressor coolant R134a type EMT6160Z 220-240V 50Hz HBP 7.8kg 1/4HP cylinder capacity 6.76cm ³ CSIR H 166mmWWW 325W 412W 513W 630W 762W 910W ambient temperature max. 45°C		



No.	605209	Ref. No.	64850086
description	compressor coolant R134a type NEK6187Z-A 220-240V 50Hz HBP 11kg 1/3HP cylinder capacity 10cm ³ CSIR H 200mmWWW 365W 482W 624W 791W 983W 1201W test method EN 12900 ambient temperature max. 55°C		

No.	605079	Ref. No.	64850040
description	compressor coolant R134a type NT6215Z 220-240V 50Hz HBP fully hermetic 17kg 1/2HP cylinder capacity 17.4cm ³ CSIR H 207mmWWW 484W 646W 843W 1071W 1326W 1606W test method EN 12900		

R404a/R507

LBP monophase

Lower evaporation temperature below -20°C



No.	605260	Ref. No.	64850045
description	compressor coolant R404A type NT2192GK 220/240V 50Hz LBP 17.5kg 1.1HP cylinder capacity 22.37cm ³ CSCR 815W 1066W 1361W 1701W 2085WWWWW		

fans

refrigeration fans

cold air circulating fans (complete)

ebm-papst

R2E series

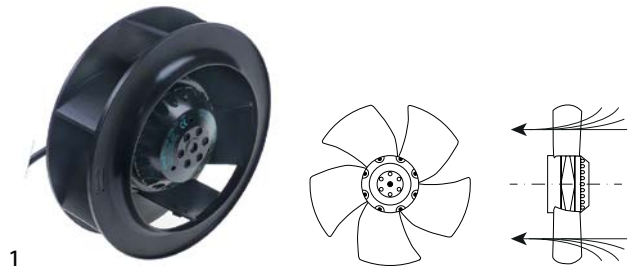

No.	601536	Ref. No.	64840010
description	fan R2E190-A026-73 fan wheel ø 190mm blades 6 230V 50/60Hz 58/75W ø 190mm H 70mm 2700rpm cable length 450mm rotation direction right ebm-papst sucking suitable capacitor 2µF		
spare parts for	601536		
No.	365170	Ref. No.	—
description	capacitor capacity 2µF 425V tolerance 5% 50/60Hz ambient temperature max. -25 to +85°C ø 25mm L 49mm M8 plastic connection cable 250mm 416.17.74 protection		

handles and hand wheels

bracket handles



1			
No.	690451	Ref. No.	64700185
description	pull handle L 426mm H 40mm mounting distance 376mm black		

hinges

spring assisted hinges

universal

INTERKLIMAT

hinges

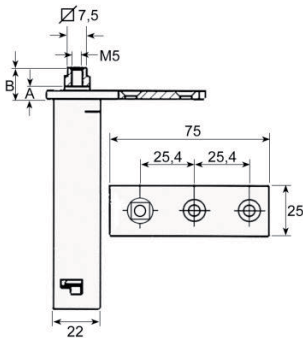
1			
No.	690714	Ref. No.	64700125 64700128 64700160
description	spring assisted hinge series 28XC mounting pos. left/right L 75mm W 25mm H 103mm A 8mm B 11mm intake 7.5x7.5 refrigeration units mounting distance 25mm		

gaskets

refrigeration gaskets

plug-in gaskets

profile 9048

We offer custom-made gaskets for this profile

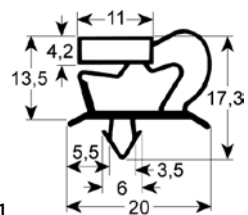

1			
No.	901677	Ref. No.	64700010
description	refrigeration gasket profile 9048 W 650mm L 1550mm plug size		

profile 9703

We offer custom-made gaskets for this profile

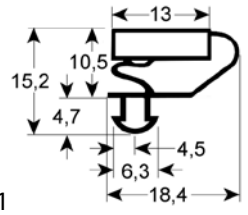

1			
No.	901791	Ref. No.	64600000
description	refrigeration gasket profile 9703 W 659mm L 731mm plug size		

profile 9704

We offer custom-made gaskets for this profile

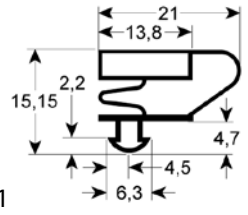

1			
No.	902411	Ref. No.	64691036
description	refrigeration gasket profile 9704 W 285mm L 415mm plug size		

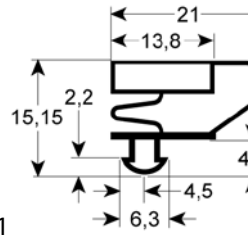

1			
No.	901031	Ref. No.	N/A
description	refrigeration gasket profile 9704 W 295mm L 423mm plug size L1 414mm W1 286mm external size		

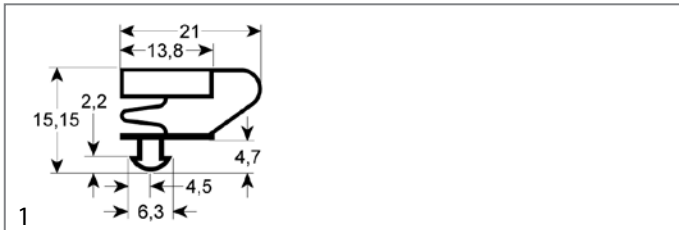

No.	902414	Ref. No.	64691084
description	refrigeration gasket profile 9704 W 395mm L 708mm plug size		

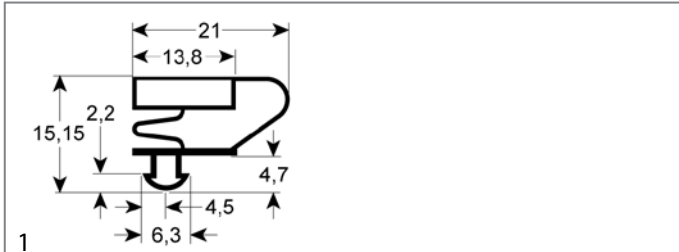

No.	901030	Ref. No.	64691002
description	refrigeration gasket profile 9704 W 423mm L 620mm plug size L1 611mm W1 414mm external size		

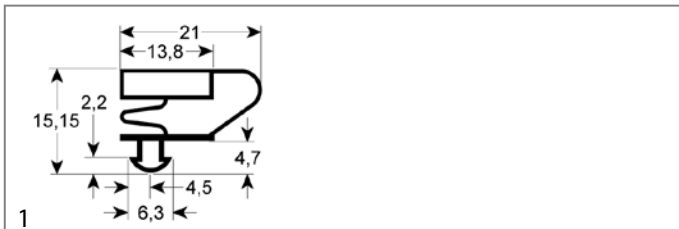

No.	902412	Ref. No.	64691020 64700055
description	refrigeration gasket profile 9704 W 454mm L 533mm plug size		

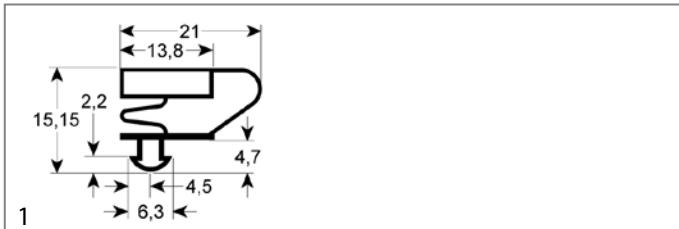

No.	902413	Ref. No.	64691004
description	refrigeration gasket profile 9704 W 475mm L 610mm plug size		

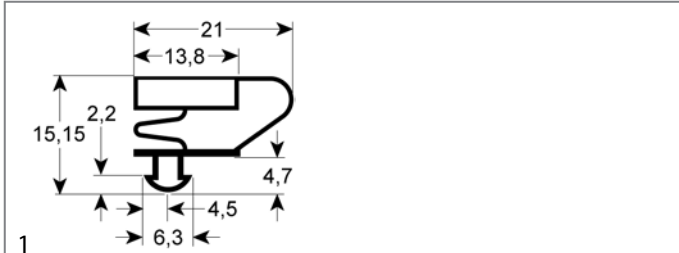

No.	902131	Ref. No.	N/A
description	refrigeration gasket profile 9704 W 669mm L 1552mm plug size		

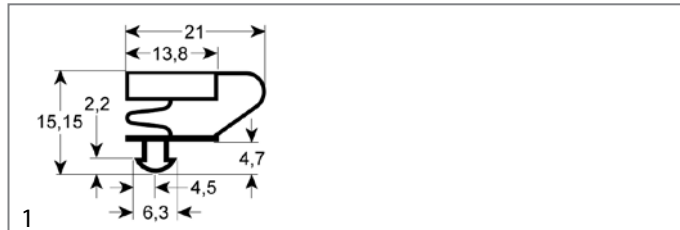

No.	902299	Ref. No.	N/A
description	refrigeration gasket profile 9704 Wmm L 2500mm		

profile 9753

We offer custom-made gaskets for this profile

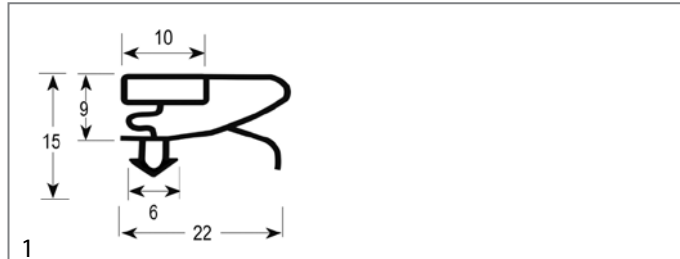

No.	901032	Ref. No.	64691038 N/A
description	refrigeration gasket profile 9753 W 186mm L 423mm plug size		

evaporation and condensing trays
unheated condensing trays



No.	699209	Ref. No.	64860132
description	drip tray L 420mm W 85mm H 35mm for evaporator		