

# Professionall

Solutii profesionale pentru echipamente profesionale



**GAS COMPONENTS**



**ELECTRIC COMPONENTS**



**WATER TECHNOLOGY**



**MECHANICAL COMPONENTS**



**TOOLS**

Spare parts suitable for

# SANREMO





## heating elements

### heating elements for coffee machine

			
1			
<b>No.</b>	417280	<b>Ref. No.</b>	10455014
<b>description</b>	heating element 1000W 220V heating circuits 1 ø 50mm H 60mm W1 45mm H1 20mm H2 40mm mounting distance 35mm thread M10x1 windings 4 tube ø 6.3mm immersion heater 2 hole fixing connection male faston 6.3mm		

			
1			
<b>No.</b>	417377	<b>Ref. No.</b>	10455050
<b>description</b>	heating element 1950W 230V heating circuits 3 thread 1¼" L 180mm W 28mm tube ø 8.5mm thermostat sleeves ø 7mm length thermostat sleeves 150mm number of thermostat sleeves 1 thermostat sleeve centre connection M4 immersion heater WS 38 suitable for SANREMO		

			
1			
<b>No.</b>	417378	<b>Ref. No.</b>	10455052
<b>description</b>	heating element 2700W 230V heating circuits 3 thread 1¼" L 325mm W 34mm H 35mm tube ø 8.5mm thermostat sleeves ø 7mm length thermostat sleeves 220mm thermostat sleeve centre connection M4 immersion heater connection length 12mm WS 38 suitable for SANREMO		

			
1			
<b>No.</b>	417379	<b>Ref. No.</b>	10455080
<b>description</b>	heating element 4500W 230V heating circuits 3 thread 1¼" L 325mm W 35mm H 35mm tube ø 8.5mm thermostat sleeves ø 7mm length thermostat sleeves 220mm thermostat sleeve centre connection M4 immersion heater connection length 12mm WS 38 suitable for SANREMO		

			
1			
<b>No.</b>	417380	<b>Ref. No.</b>	10455054
<b>description</b>	heating element 5100W 230V heating circuits 3 thread 1¼" L 485mm W 35mm H 35mm tube ø 8.5mm thermostat sleeves ø 7mm length thermostat sleeves 140mm thermostat sleeve centre connection M3 immersion heater connection length 12mm WS 38 suitable for SANREMO		

## thermostats

### bi-metal thermostats

<h4>safety bi-metal thermostats</h4>			
			
1			
<b>No.</b>	390311	<b>Ref. No.</b>	10111049
<b>description</b>	bi-metal safety thermostat hole distance mm switch-off temp. 135°C 1NC 1-pole 16A connection F6.3 M4		

### control and safety thermostats

<h4>EGO</h4>			
<h4>safety thermostats</h4>			
<h4>55.32_series</h4>			
			
1			
<b>No.</b>	390324	<b>Ref. No.</b>	10111015
<b>description</b>	safety thermostat switch-off temp. 169°C 3-pole 3NC 20A probe ø 4mm probe L 128mm capillary pipe 890mm capillary pipe isolated 210/210mm gland nut probe S5		

## switches and momentary switches

### rocker/momentary rocker switches

<h4>30x22mm</h4>			
			
1			
<b>No.</b>	301036	<b>Ref. No.</b>	10105243A
<b>description</b>	protective cover internal size 30x22mm for rocker switch mounting measurementsmm		

			
1			
<b>No.</b>	347306	<b>Ref. No.</b>	10555042
<b>description</b>	momentary rocker switch mounting measurements 30x22mm orange 2NO 250V 16A illuminated water connection male faston 6.3mm ambient temperature max. 85°C protection IP40		



1

<b>No.</b>	346110	<b>Ref. No.</b>	10555060
<b>description</b>	rocker switch mounting measurements 30x22mm red 2NO 250V 16A illuminated coffee connection male faston 6.3mm ambient temperature max. 125/55°C protection IP40		

## push/momentary push switches

30x22mm



1

<b>No.</b>	301036	<b>Ref. No.</b>	10105243A
<b>description</b>	protective cover internal size 30x22mm for rocker switch mounting measurementsmm		

## system switches (ROLD)



1

<b>No.</b>	347308	<b>Ref. No.</b>	10553078
<b>description</b>	element holder mounting ø 16mm arched black ø 15.9mm ED ø 20mm H 23.5mm		



1

<b>No.</b>	347309	<b>Ref. No.</b>	10553086
<b>description</b>	push button ø 11.9mm black coffee shaft L 4mm shaft 3.7x3.7mm		



1

<b>No.</b>	347310	<b>Ref. No.</b>	10553088
<b>description</b>	push button ø 11.9mm black cup warmer shaft L 4mm shaft 3.7x3.7mm		



1

<b>No.</b>	347315	<b>Ref. No.</b>	10553090
<b>description</b>	push button ø 11.9mm black light		



1

<b>No.</b>	347192	<b>Ref. No.</b>	10553080
<b>description</b>	switch 2NO 250V 16A connection male faston 6.3mm		
<b>accessories for</b>	347192		
	<b>No.</b>	347183	<b>Ref. No.</b>
			—
	push button mounting ø 14.3mm chrome-plated		

## rotary switches

GIOVENZANA

rotary switches



1

<b>No.</b>	347302	<b>Ref. No.</b>	10122016 10122036A 10122050
<b>description</b>	rotary switch 2 0-1 sets of contacts 6 type P0200514S 690V 20A shaft ø 8x7mm shaft L 19mm shaft star-shaped connection screw		
<b>accessories for</b>	347302		
	<b>No.</b>	112615	<b>Ref. No.</b>
			10122015
	knob with indicator ø 35mm H 22mm shaft diameter 8x7mm black		



1

<b>No.</b>	347303	<b>Ref. No.</b>	10122018 10122038A 10122060
<b>description</b>	rotary switch 3 0-1 sets of contacts 6 type PO20 690V 20A shaft ø 8x7mm shaft L 19mm shaft star-shaped connection screw		
<b>accessories for</b>	347303		
	<b>No.</b>	112615	<b>Ref. No.</b>
			10122015
	knob with indicator ø 35mm H 22mm shaft diameter 8x7mm black		



accessories

knobs



1

<b>No.</b>	111371	<b>Ref. No.</b>	10122012
<b>description</b>	knob ø 27/46mm black shaft diameter 6x6mm with screw		



1

<b>No.</b>	112615	<b>Ref. No.</b>	10122015
<b>description</b>	knob with indicator ø 35mm H 22mm shaft diameter 8x7mm black		

lamps

indicator lights

indicator lights (complete)

ø 6mm



1

<b>No.</b>	359569	<b>Ref. No.</b>	10553021
<b>description</b>	indicator light ø 6mm 230V yellow cable length 250mm temp.-resist. 150°C		

solid state relays

CRYDOM



1

<b>No.</b>	402490	<b>Ref. No.</b>	10112216A
<b>description</b>	solid state relay CRYDOM 3 phase 50A 530V 4-32VDC L 105mm W 74mm screw type D53TP50D		

CROUZET



1

<b>No.</b>	403542	<b>Ref. No.</b>	10112216A
<b>description</b>	solid state relay CROUZET 3 phase 50A 48-600V 4-32VDC L 105mm W 80mm screw type GN350DLZ		

relays

level relays

GICAR



1

<b>No.</b>	402103	<b>Ref. No.</b>	10112010A
<b>description</b>	level controller 230/240V voltage AC 50/60Hz connection F6.3 type NRL30/1E-2C/F		

probes

producer-specific probes

probes



1

<b>No.</b>	379452	<b>Ref. No.</b>	10112178
<b>description</b>	temperature probe NTC cable glass fibre probe -40 up to +125°C cable -50 up to +350°C connection plug thread 1/4" probe ø3.5x20mm cable length 0.24m		

electronics

electronics accessories





1

<b>No.</b>	525622	<b>Ref. No.</b>	10401034
<b>description</b>	spacer piece for keypad L 13.5mm ø 6mm ID ø 3.5mm		



PCBs

			
1	<b>No.</b>	402481	<b>Ref. No.</b>
			10112044
<b>description</b>	display for coffee machine L 106mm W 36mm suitable for SANREMO		

			
1	<b>No.</b>	402483	<b>Ref. No.</b>
			10112168
<b>description</b>	display for coffee machine L 74mm W 26mm suitable for SANREMO model ROMA		

			
1	<b>No.</b>	402482	<b>Ref. No.</b>
			10112162
<b>description</b>	display for coffee machine L 74mm W 26mm suitable for SANREMO model VERONA		

			
1	<b>No.</b>	402486	<b>Ref. No.</b>
			10112087B
<b>description</b>	keypad PCB coffee machine MILANO L 123mm W 35mm buttons 6		

			
1	<b>No.</b>	402484	<b>Ref. No.</b>
			10112099B
<b>description</b>	keypad PCB for coffee machine L 123mm W 35mm buttons 2		

			
1	<b>No.</b>	402485	<b>Ref. No.</b>
			10112057B
<b>description</b>	keypad PCB for coffee machine L 123mm W 35mm buttons 5		

central units

			
1	<b>No.</b>	402468	<b>Ref. No.</b>
			10112091A 10112091D
<b>description</b>	central unit		

			
1	<b>No.</b>	402801	<b>Ref. No.</b>
			10112071A 10112071C 10112072A 10112072B 10112072D
<b>description</b>	central unit 230V 50/60Hz type 3d5 3GRCT XLC (SC) „T.M.-DL“ voltage AC		

			
1	<b>No.</b>	402802	<b>Ref. No.</b>
			10112171 10112172 10112174 10112175
<b>description</b>	central unit 240V 50/60Hz type 3d5 MAESTRO DELUXE 6T voltage AC		

			
1	<b>No.</b>	402803	<b>Ref. No.</b>
			10112091A 10112091D
<b>description</b>	central unit 250V 50/60Hz type E.T.30 F 2GRCT voltage AC		

			
1	<b>No.</b>	402464	<b>Ref. No.</b>
			10112182
<b>description</b>	control box		



1

<b>No.</b>	402465	<b>Ref. No.</b>	10112058A
<b>description</b>	control box		



1

<b>No.</b>	402472	<b>Ref. No.</b>	10112173B
<b>description</b>	control box		



1

<b>No.</b>	402466	<b>Ref. No.</b>	10112086B
<b>description</b>	control box		



1

<b>No.</b>	402474	<b>Ref. No.</b>	10112186
<b>description</b>	control box		



1

<b>No.</b>	402467	<b>Ref. No.</b>	10112102A
<b>description</b>	control box		



1

<b>No.</b>	402849	<b>Ref. No.</b>	10112180A
<b>description</b>	control box		



1

<b>No.</b>	402469	<b>Ref. No.</b>	10112072C 10112083C
<b>description</b>	control box		



1

<b>No.</b>	402471	<b>Ref. No.</b>	10112112B 8SR12112
<b>description</b>	control box 230/240V 50/60Hz type 3d5 3GRCT XLC (SC)		



# keypads

## keypad units

1 

<b>No.</b>	402477	<b>Ref. No.</b>	10112164
<b>description</b>	keypad unit buttons 2 suitable for SANREMO L 146mm W 46mm		

1 

<b>No.</b>	402479	<b>Ref. No.</b>	10112122
<b>description</b>	keypad unit buttons 5 suitable for SANREMO L 120mm W 50mm		

1 

<b>No.</b>	402480	<b>Ref. No.</b>	10112066A
<b>description</b>	keypad unit buttons 5 suitable for SANREMO L 120mm W 50mm		

1 

<b>No.</b>	402475	<b>Ref. No.</b>	10112166
<b>description</b>	keypad unit buttons 6 suitable for SANREMO L 133mm W 40mm		

1 

<b>No.</b>	402478	<b>Ref. No.</b>	10112138
<b>description</b>	keypad unit buttons 6 suitable for SANREMO L 142mm W 50mm		

1 

<b>No.</b>	402476	<b>Ref. No.</b>	10112158A
<b>description</b>	keypad unit buttons 6 suitable for SANREMO L 146mm W 42mm		

## accessories

1 

<b>No.</b>	525576	<b>Ref. No.</b>	10029630A
<b>description</b>	button round ø 17mm plastic black 1 cup large SANREMO		

1 

<b>No.</b>	525573	<b>Ref. No.</b>	10029626A
<b>description</b>	button round ø 17mm plastic black 1 cup small SANREMO		

1 

<b>No.</b>	525582	<b>Ref. No.</b>	10029632A
<b>description</b>	button round ø 17mm plastic black 2 cups large SANREMO		

1 

<b>No.</b>	525579	<b>Ref. No.</b>	10029631A
<b>description</b>	button round ø 17mm plastic black 2 cups small SANREMO		

1 

<b>No.</b>	525585	<b>Ref. No.</b>	10029641A
<b>description</b>	button round ø 17mm plastic black coffee start/stop SANREMO		



			
1			
<b>No.</b>	525575	<b>Ref. No.</b>	10029636A
<b>description</b>	button round ø 17mm plastic blue 1 cup large SANREMO		

			
1			
<b>No.</b>	525574	<b>Ref. No.</b>	10029616A
<b>description</b>	button round ø 17mm plastic red 1 cup small SANREMO		

			
1			
<b>No.</b>	525572	<b>Ref. No.</b>	10029635A
<b>description</b>	button round ø 17mm plastic blue 1 cup small SANREMO		

			
1			
<b>No.</b>	525583	<b>Ref. No.</b>	10029621A
<b>description</b>	button round ø 17mm plastic red 2 cups large SANREMO		

			
1			
<b>No.</b>	525581	<b>Ref. No.</b>	10029639A
<b>description</b>	button round ø 17mm plastic blue 2 cups large SANREMO		

			
1			
<b>No.</b>	525580	<b>Ref. No.</b>	10029620A
<b>description</b>	button round ø 17mm plastic red 2 cups small SANREMO		

			
1			
<b>No.</b>	525578	<b>Ref. No.</b>	10029637A
<b>description</b>	button round ø 17mm plastic blue 2 cups small SANREMO		

			
1			
<b>No.</b>	525586	<b>Ref. No.</b>	10029622A
<b>description</b>	button round ø 17mm plastic red coffee start/stop SANREMO		

			
1			
<b>No.</b>	525584	<b>Ref. No.</b>	10029638A
<b>description</b>	button round ø 17mm plastic blue coffee start/stop SANREMO		

			
1			
<b>No.</b>	525588	<b>Ref. No.</b>	10029662A 10029662B
<b>description</b>	keys round ø 17mm plastic set 2-piece black coffee/water SANREMO		

			
1			
<b>No.</b>	525577	<b>Ref. No.</b>	10029619A
<b>description</b>	button round ø 17mm plastic red 1 cup large SANREMO		

			
1			
<b>No.</b>	525587	<b>Ref. No.</b>	10029661
<b>description</b>	keys round ø 17mm plastic set 2-piece blue coffee/water SANREMO		





			
1			
<b>No.</b>	525589	<b>Ref. No.</b>	10029663A
<b>description</b>	keys round ø 17mm plastic set 2-piece red coffee/water SANREMO		







			
1			
<b>No.</b>	525591	<b>Ref. No.</b>	10029656A
<b>description</b>	keys round ø 17mm plastic set 6-piece black SANREMO		

			
1			
<b>No.</b>	525590	<b>Ref. No.</b>	10029657
<b>description</b>	keys round ø 17mm plastic set 6-piece blue SANREMO		

			
1			
<b>No.</b>	525592	<b>Ref. No.</b>	10029645A 8SR9645
<b>description</b>	keys round ø 17mm plastic set 6-piece red SANREMO		

<b>E-146 series</b>			
			
1			
<b>No.</b>	370574	<b>Ref. No.</b>	10303088
<b>description</b>	solenoid valve 2-ways 230VAC inlet 1/8" outlet 1/8" connection 1/8" L 30mm DN 2.5mm slide-on receptacle DIN -20° up to 130°C PARKER type series VE-146.2FV coil type ZB09 membranes FKM (water) p max 15bar brass		
<b>spare parts for</b>	370574		
	<b>No.</b>	371029	<b>Ref. No.</b> —
	solenoid coil PARKER 230VAC 9VA coil type ZB09 seat ø 14mm H 33mm W 34mm D 43mm		

<b>VE-175BV series</b>			
			
1			
<b>No.</b>	370576	<b>Ref. No.</b>	10303080
<b>description</b>	solenoid valve brass 2-ways 230VAC connection DN 2mm -10 up to 140°C PARKER type series VE-175BV coil type WB4.5 membranes FKM (water/steam) p max 15bar p min 0bar flange 25x25mm		

<b>3-way</b>			
<b>VE-128 series</b>			
			
1			
<b>No.</b>	370057	<b>Ref. No.</b>	10302066
<b>description</b>	solenoid valve 3-ways 230VAC body outer cone DN 1.2mm slide-on receptacle DIN -20° up to 140°C PARKER type series VE-128 coil type ZB09 membranes ruby p max 10bar brass flange 32x32mm		
<b>spare parts for</b>	370057		
	<b>No.</b>	370062	<b>Ref. No.</b> —
	solenoid valve body PARKER 3-ways outer cone		
	<b>No.</b>	371029	<b>Ref. No.</b> —
	solenoid coil PARKER 230VAC 9VA coil type ZB09 seat ø 14mm H 33mm W 34mm D 43mm		
<b>accessories for</b>	370057		
	<b>No.</b>	371090	<b>Ref. No.</b> —
	power socket plug type DIN 43650A screw		
	<b>No.</b>	371095	<b>Ref. No.</b> —
	O-ring Viton thickness 1.78mm ID ø 6.07mm Qty 1 pcs		
	<b>No.</b>	371100	<b>Ref. No.</b> —
	O-ring silicone thickness 1.78mm ID ø 6.07mm Qty 1 pcs		

## solenoid valves



### solenoid valves (water)

metal

PARKER

2-way

VE-140 series

			
1			
<b>No.</b>	370575	<b>Ref. No.</b>	10303086
<b>description</b>	solenoid valve 2-ways 230VAC connection 1/8" L 30mm DN 2.5mm slide-on receptacle DIN -10 up to 140°C PARKER type series 11804F1 / 10708T coil type ZB09 membranes ruby p max 30bar 230V nickel-plated brass		
<b>spare parts for</b>	370575		
	<b>No.</b>	371029	<b>Ref. No.</b> —
	solenoid coil PARKER 230VAC 9VA coil type ZB09 seat ø 14mm H 33mm W 34mm D 43mm		





## pressure switches

### for coffee machines

#### miscellaneous



1

<b>No.</b>	541021	<b>Ref. No.</b>	10602010A
<b>description</b>	pressure control pressure range adjustable 0.5-1.4bar connection 1/4" 30A 3-pole type P302 coffee machine parts SIRAI		
<b>accessories for</b>	541021		
	<b>No.</b>	550262	<b>Ref. No.</b> —
<b>description</b>	flat gasket copper ED ø 20mm ID ø 14mm thickness 2mm		
	<b>No.</b>	890100	<b>Ref. No.</b> —
<b>description</b>	PTFE tape reel L 12m W 12mm -200 up to +260°C approval DIN-DVGW, KTW temperature-resistant, elastic for fine thread thickness 0.1mm		

## electrodes



1

<b>No.</b>	400212	<b>Ref. No.</b>	10112064
<b>description</b>	level electrode 1/4" total length 120mm probe L 94mm insulated probe length 26mm connection male faston 6.3mm stainless steel ø 2.5mm		



1

<b>No.</b>	400214	<b>Ref. No.</b>	10112042
<b>description</b>	level electrode 1/4" total length 140mm probe L 112mm insulated probe length 26mm connection male faston 6.3mm stainless steel ø 2.5mm		

## equipment-specific units

### for espresso machines

#### filter holders

##### filter holders standard

##### filter holder without spout



1

<b>No.</b>	525977	<b>Ref. No.</b>	N/A
<b>description</b>	filter holder suitable for CREM-EXPOBAR/WEGA/GRIMAC/SANRAMO without outlet mounting ø 83mm outlet 3/8" ID ø 61.5mm wedge high 10mm wedge position horizontal number of wedges 2 lever inclined		

##### filter holders short



1

<b>No.</b>	529933	<b>Ref. No.</b>	10052034
<b>description</b>	filter holder mounting ø 82.4mm outlet 3/8" ID ø 61.5mm handle M12x1.75 wedge high 9.5mm wedge position horizontal number of wedges 2 lever inclined chrome-plated, polished		



1

<b>No.</b>	525603	<b>Ref. No.</b>	10052034
<b>description</b>	filter holder mounting ø 83mm outlet 3/8" ID ø 61.5mm handle M12x1.75 wedge high 10mm wedge position horizontal number of wedges 2 lever inclined chrome-plated brass		

#### spouts

##### with thread 3/8"



1

<b>No.</b>	529003	<b>Ref. No.</b>	10052080
<b>description</b>	filter holder spout thread 3/8" 1-way curved/long outlet distancemm thread L 5mm		

## filters

## for 1 cup



1

<b>No.</b>	529012	<b>Ref. No.</b>	10052101
<b>description</b>	coffee filter $\phi$ 70mm mounting $\phi$ 60.8mm H 19.5mm cups 1 amount of coffee 6g		



1

<b>No.</b>	529011	<b>Ref. No.</b>	10052100
<b>description</b>	coffee filter $\phi$ 70mm mounting $\phi$ 60mm H 24.5mm cups 1 amount of coffee 7g perforation $\phi$ 0.4mm		

## for 2 cups



1

<b>No.</b>	529013	<b>Ref. No.</b>	10052110
<b>description</b>	coffee filter $\phi$ 70mm mounting $\phi$ 60.5mm H 25.5mm cups 2 amount of coffee 14g perforation $\phi$ 0.3x0.3mm square		

## filter holder springs



1

<b>No.</b>	531243	<b>Ref. No.</b>	10052055
<b>description</b>	filter holder spring L 70mm W 60mm wire gauge $\phi$ 1.3mm for espresso filter holder Qty 20 pcs		

## brewing units

## shower screens

## flat



1

<b>No.</b>	529084	<b>Ref. No.</b>	10052170
<b>description</b>	shower screen $\phi$ 52mm hole $\phi$ 6.4mm		

## with upstand



1

<b>No.</b>	529080	<b>Ref. No.</b>	10052120
<b>description</b>	shower screen $\phi$ 58mm H 20mm		

## filter holder gaskets

## flat

## standard



1

<b>No.</b>	525607	<b>Ref. No.</b>	10502110
<b>description</b>	filter holder gasket D1 $\phi$ 73mm D2 $\phi$ 57mm H 8.2mm Qty 1 pcs		

## with bevel 45x2



1

<b>No.</b>	525606	<b>Ref. No.</b>	10502038
<b>description</b>	filter holder gasket D1 $\phi$ 73mm D2 $\phi$ 56.5mm H 8mm with outside notch		

## components

## nozzles

## with thread



1

<b>No.</b>	528486	<b>Ref. No.</b>	10052135
<b>description</b>	nozzle bore $\phi$ 0.7mm thread M6x0.75 L 9mm WS 7		

## water dispersions

## water dispersions

## group 2



1

<b>No.</b>	529081	<b>Ref. No.</b>	10052141
<b>description</b>	water distributor $\phi$ 30mm hole $\phi$ 1.5mm H 15mm ET M10x1 grooves 6 2.5mm brass		

safety valves

safety valves

3/8"



1

<b>No.</b>	525619	<b>Ref. No.</b>	10652010 10652012
<b>description</b>	safety valve connection 3/8" triggering pressure 1.8bar approval CE 0036 suitable for SANREMO sealed		

expansion valves

with hose connection



1

<b>No.</b>	524667	<b>Ref. No.</b>	10655557
<b>description</b>	expansion valve T1: 1/8" ET hose ø 7mm total length 47mm		



1

<b>No.</b>	525618	<b>Ref. No.</b>	10655555
<b>description</b>	expansion valve T1: 1/8" ET hose ø 7mm total length 69mm		

drain valves



1

<b>No.</b>	525620	<b>Ref. No.</b>	10402059
<b>description</b>	drain fitting inlet 1/8" outlet 1/8" 1/4" shaft 5x5		

drain pans

drain pans



1

<b>No.</b>	525605	<b>Ref. No.</b>	10022461
<b>description</b>	drain pan L 135mm W 110mm H 45mm hole ø 16mm connection rear suitable for SANREMO thread L 14mm		



1

<b>No.</b>	525604	<b>Ref. No.</b>	10022429
<b>description</b>	drain pan L 135mm W 110mm H 45mm hole ø 16mm connection right suitable for SANREMO thread L 14mm		



1

<b>No.</b>	525615	<b>Ref. No.</b>	10022474
<b>description</b>	drain pan L 90mm W 80mm H 43mm hole ø 16mm suitable for SANREMO		

aerators and air bleeders



1

<b>No.</b>	529303	<b>Ref. No.</b>	10652040A
<b>description</b>	aerator and air bleeder connection 1/4" only steam		

spare parts for 529303



<b>No.</b>	528687	<b>Ref. No.</b>	—
<b>description</b>	O-ring Viton thickness 1.78mm ID ø 3.69mm Qty 1 pcs		

steam/water taps

steam/water taps

steam/water taps



1

<b>No.</b>	525593	<b>Ref. No.</b>	10402120A
<b>description</b>	steam/water tap suitable for SANREMO		

## steam taps

## steam taps (complete)



1

<b>No.</b>	525491	<b>Ref. No.</b>	N/A
<b>description</b>	steam tap complete with handle inlet 1/4" brass pipe SS pipe length 180mm tube ø 10mm		



1

<b>No.</b>	525492	<b>Ref. No.</b>	N/A
<b>description</b>	water pipe complete with handle inlet 1/4" brass pipe SS pipe length 100mm tube ø 10mm		

## components

## bushes



1

<b>No.</b>	526010	<b>Ref. No.</b>	10402015
<b>description</b>	bush steam/water tap D1 ø 10.5mm D2 ø 9mm ID ø 6.3mm H 4.6mm brass		

accessories for 526010

<b>No.</b>	526005	<b>Ref. No.</b>	—
------------	--------	-----------------	---

shaft steam tap ø 14.8mm L 92.5mm thread M6 brass

## gaskets



1

<b>No.</b>	527960	<b>Ref. No.</b>	10505558
<b>description</b>	gasket D1 ø 12mm thickness 6mm for steam-/water-tap		

## steam/water pipes

## steam pipes



1

<b>No.</b>	525600	<b>Ref. No.</b>	10402270A
<b>description</b>	steam pipe L 160mm tube ø 10mm IT 3/8" SS SANREMO		



1

<b>No.</b>	525599	<b>Ref. No.</b>	10402286D
<b>description</b>	steam pipe L 170mm tube ø 10mm IT 3/8" SS SANREMO		



1

<b>No.</b>	525598	<b>Ref. No.</b>	10402260A
<b>description</b>	steam pipe L 200mm tube ø 10mm IT 3/8" SS SANREMO		



1

<b>No.</b>	525601	<b>Ref. No.</b>	10402280A
<b>description</b>	steam pipe L 210mm tube ø 10mm IT 3/8" SS SANREMO		



1

<b>No.</b>	525602	<b>Ref. No.</b>	10402284
<b>description</b>	steam pipe L 210mm tube ø 10mm IT 3/8" SS SANREMO		

## nozzles for water pipes

## nozzles for water pipes



1

<b>No.</b>	526637	<b>Ref. No.</b>	10402140
<b>description</b>	water nozzle D1 ø 24mm H 29mm int. ø 19mm		





water pipes



1

<b>No.</b>	525616	<b>Ref. No.</b>	10402145
<b>description</b>	water pipe thread 3/8" ø 23.5mm L 112mm tube ø 8mm WS 22		
<b>accessories for</b>	525616		
	<b>No.</b>	526637	<b>Ref. No.</b>
			10402140
<b>description</b>	water nozzle D1 ø 24mm H 29mm int. ø 19mm		

accessories

bushes



1

<b>No.</b>	529705	<b>Ref. No.</b>	10402054
<b>description</b>	bush D1 ø 8.3mm D2 ø 12mm H 6mm brass ID ø 7mm		

springs



1

<b>No.</b>	529704	<b>Ref. No.</b>	10402043
<b>description</b>	compression spring ø 11.8mm L 16mm wire gauge ø 1.6mm steel		

tube handles



1

<b>No.</b>	525042	<b>Ref. No.</b>	10753052
<b>description</b>	tube handle for pipe ø 10mm ø 13.5mm L 50mm rubber		



1

<b>No.</b>	528625	<b>Ref. No.</b>	10753050
<b>description</b>	tube handle L 35mm rubber ID ø 8mm		

fine filters

fine filters



1

<b>No.</b>	529979	<b>Ref. No.</b>	10052136
<b>description</b>	fine filter ø 8.8mm H 22mm		

intake valves

intake valves

1

<b>No.</b>	531074	<b>Ref. No.</b>	10052080B 10056080B
<b>description</b>	intake valve complete		



1

<b>No.</b>	525567	<b>Ref. No.</b>	10056076A
<b>description</b>	intake valve complete for SANREMO		

<b>spare parts for</b>	525567		
------------------------	--------	--	--

	<b>No.</b>	370575	<b>Ref. No.</b>
			10303086
<b>description</b>	solenoid valve 2-ways 230VAC connection 1/8" L 30mm DN 2.5mm slide-on receptacle DIN -10 up to 140°C PARKER type series 11804F1 / 10708T coil type ZB09 membranes ruby p max 30bar 230V nickel-plated brass		

	<b>No.</b>	371029	<b>Ref. No.</b>
			—
<b>description</b>	solenoid coil PARKER 230VAC 9VA coil type ZB09 seat ø 14mm H 33mm W 34mm D 43mm		





1

<b>No.</b>	525568	<b>Ref. No.</b>	10056061A
<b>description</b>	intake valve complete for SANREMO		





<b>spare parts for</b>	525568		
------------------------	--------	--	--



	<b>No.</b>	370575	<b>Ref. No.</b>
			10303086
<b>description</b>	solenoid valve 2-ways 230VAC connection 1/8" L 30mm DN 2.5mm slide-on receptacle DIN -10 up to 140°C PARKER type series 11804F1 / 10708T coil type ZB09 membranes ruby p max 30bar 230V nickel-plated brass		

	<b>No.</b>	371029	<b>Ref. No.</b>
			—
<b>description</b>	solenoid coil PARKER 230VAC 9VA coil type ZB09 seat ø 14mm H 33mm W 34mm D 43mm		

			
1			
<b>No.</b>	525569	<b>Ref. No.</b>	10056088
<b>description</b>	intake valve complete for SANREMO		
<b>spare parts for</b>	525569		
	<b>No.</b>	370575	<b>Ref. No.</b> 10303086
	solenoid valve 2-ways 230VAC connection 1/8" L 30mm DN 2.5mm slide-on receptacle DIN -10 up to 140°C PARKER type series 11804F1 / 10708T coil type ZB09 membranes ruby p max 30bar 230V nickel-plated brass		
	<b>No.</b>	371029	<b>Ref. No.</b> —
	solenoid coil PARKER 230VAC 9VA coil type ZB09 seat ø 14mm H 33mm W 34mm D 43mm		

			
1			
<b>No.</b>	525570	<b>Ref. No.</b>	10056084
<b>description</b>	intake valve complete for SANREMO		
<b>spare parts for</b>	525570		
	<b>No.</b>	370202	<b>Ref. No.</b> —
	solenoid valve 2-ways 230VAC connection DN 2.5mm slide-on receptacle DIN -20° up to 130°C PARKER type series VE-125 coil type ZB09 membranes FKM (water) p max 10bar flange 32x32mm		
	<b>No.</b>	371029	<b>Ref. No.</b> —
	solenoid coil PARKER 230VAC 9VA coil type ZB09 seat ø 14mm H 33mm W 34mm D 43mm		
<b>accessories for</b>	525570		
	<b>No.</b>	371090	<b>Ref. No.</b> —
	power socket plug type DIN 43650A screw		
	<b>No.</b>	532553	<b>Ref. No.</b> —
	O-ring silicone thickness 1.5mm ID ø 13.15mm Qty 1 pcs		
	<b>No.</b>	532554	<b>Ref. No.</b> —
	O-ring silicone thickness 1.5mm ID ø 4.1mm Qty 1 pcs		

			
1			
<b>No.</b>	525571	<b>Ref. No.</b>	10053162
<b>description</b>	intake valve complete for SANREMO		
<b>spare parts for</b>	525571		
	<b>No.</b>	370202	<b>Ref. No.</b> —
	solenoid valve 2-ways 230VAC connection DN 2.5mm slide-on receptacle DIN -20° up to 130°C PARKER type series VE-125 coil type ZB09 membranes FKM (water) p max 10bar flange 32x32mm		
	<b>No.</b>	371029	<b>Ref. No.</b> —
	solenoid coil PARKER 230VAC 9VA coil type ZB09 seat ø 14mm H 33mm W 34mm D 43mm		
<b>accessories for</b>	525571		
	<b>No.</b>	371090	<b>Ref. No.</b> —
	power socket plug type DIN 43650A screw		

<b>accessories for</b>	525571		
	<b>No.</b>	532553	<b>Ref. No.</b> —
	O-ring silicone thickness 1.5mm ID ø 13.15mm Qty 1 pcs		
	<b>No.</b>	532554	<b>Ref. No.</b> —
	O-ring silicone thickness 1.5mm ID ø 4.1mm Qty 1 pcs		

## level glasses

## level glasses

## level glasses (complete)

			
1			
<b>No.</b>	525595	<b>Ref. No.</b>	10402110
<b>description</b>	water level tube L 212mm W 55mm thread 1/4"		

			
1			
<b>No.</b>	525594	<b>Ref. No.</b>	10402170A
<b>description</b>	water level tube L 212mm W 55mm thread 3/8"		

			
1			
<b>No.</b>	525596	<b>Ref. No.</b>	10402109
<b>description</b>	water level tube L 215mm W 60mm complete thread 3/8"		



1

<b>No.</b>	525597	<b>Ref. No.</b>	10402168
<b>description</b>	water level tube L 222mm W 55mm complete thread 3/8"		

level glass pipes



1

<b>No.</b>	529393	<b>Ref. No.</b>	10402100
<b>description</b>	water level tube ø 11mm H 140mm ID ø 8mm marking Min/Max		

non-return valves

complete



1

<b>No.</b>	525617	<b>Ref. No.</b>	10652020B
<b>description</b>	non-return valve inlet 1/4" outlet 1/8" L 62mm suitable for SANREMO		

miscellaneous



1

<b>No.</b>	525621	<b>Ref. No.</b>	10255028A
<b>description</b>	connecting fitting for solenoid valve T1: 1/8" for SANREMO		

**knobs**

producer-specific knobs

SANREMO



1

<b>No.</b>	111371	<b>Ref. No.</b>	10122012
<b>description</b>	knob ø 27/46mm black shaft diameter 6x6mm with screw		

steam/water taps



1

<b>No.</b>	111341	<b>Ref. No.</b>	10092160A
<b>description</b>	knob ø 43mm for rotary switch		



1

<b>No.</b>	111334	<b>Ref. No.</b>	10402074
<b>description</b>	turning handle without symbol ø 41mm L 50mm black		



1

<b>No.</b>	111337	<b>Ref. No.</b>	10092164
<b>description</b>	turning handle without symbol ø 48mm black		



1

<b>No.</b>	111338	<b>Ref. No.</b>	10091140
<b>description</b>	turning handle without symbol ø 52mm black		

knob dial plates



1

<b>No.</b>	111275	<b>Ref. No.</b>	10351104
<b>description</b>	symbol steam ø 32mm L 28mm		



1

<b>No.</b>	111335	<b>Ref. No.</b>	10351114
<b>description</b>	symbol steam ø 32mm L 29mm black		





1

<b>No.</b>	111340	<b>Ref. No.</b>	10091142
<b>description</b>	symbol tail +/- ø 45mm black		

1		<b>No.</b> 111339	<b>Ref. No.</b> 10092162
	<b>description</b>	symbol tail +/- ø 47mm black	

1		<b>No.</b> 111276	<b>Ref. No.</b> 10351105
	<b>description</b>	symbol water ø 32mm L 28mm	

1		<b>No.</b> 111336	<b>Ref. No.</b> 10351115
	<b>description</b>	symbol water ø 32mm L 29mm black	

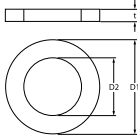
1			<b>No.</b> 528223	<b>Ref. No.</b> 10402063A
	<b>description</b>	O-ring EPDM thickness 2.62mm ID ø 11.91mm Qty 1 pcs		

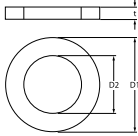
1			<b>No.</b> 505073	<b>Ref. No.</b> 10502100
	<b>description</b>	O-ring EPDM thickness 2.62mm ID ø 20.63mm Qty 1 pcs		

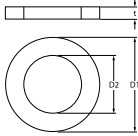
1			<b>No.</b> 540222	<b>Ref. No.</b> 10502070A
	<b>description</b>	O-ring EPDM thickness 2.62mm ID ø 47.3mm Qty 1 pcs		

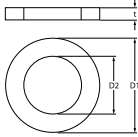
1			<b>No.</b> 525608	<b>Ref. No.</b> 10402082
	<b>description</b>	O-ring EPDM thickness 2.7mm ID ø 12.1mm		

## fittings for catering equipment

### drain taps

#### accessories

1		<b>No.</b> 540222	<b>Ref. No.</b> 10502070A
	<b>description</b>	O-ring EPDM thickness 2.62mm ID ø 47.3mm Qty 1 pcs	

## gaskets

### O-rings

#### EPDM

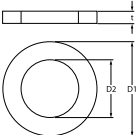
1			<b>No.</b> 528485	<b>Ref. No.</b> 10502041A
	<b>description</b>	O-ring EPDM thickness 1.78mm ID ø 6.07mm Qty 1 pcs		

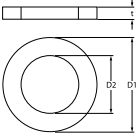
1			<b>No.</b> 529412	<b>Ref. No.</b> 10705015
	<b>description</b>	O-ring EPDM thickness 2.62mm ID ø 10.78mm Qty 1 pcs		

### silicone

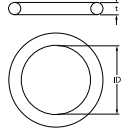
1			<b>No.</b> 523014	<b>Ref. No.</b> 10505082
	<b>description</b>	O-ring silicone thickness 2.2mm ID ø 9mm Qty 1 pcs		

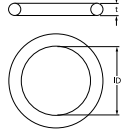
1			<b>No.</b> 532561	<b>Ref. No.</b> 10505080
	<b>description</b>	O-ring silicone thickness 2.62mm ID ø 71.12mm Qty 1 pcs		



Viton



<b>No.</b>	532565	<b>Ref. No.</b>	10402056A
<b>description</b>	O-ring Viton thickness 1.78mm ID ø 15.6mm Qty 1 pcs		

NBR



<b>No.</b>	525614	<b>Ref. No.</b>	10505121
<b>description</b>	O-ring NBR thickness 1.9mm ID ø 5.7mm Qty 1 pcs		

miscellaneous



<b>No.</b>	525608	<b>Ref. No.</b>	10402082
<b>description</b>	O-ring EPDM thickness 2.7mm ID ø 12.1mm		

sealing washers

copper gaskets

DIN-7603-A



<b>No.</b>	526860	<b>Ref. No.</b>	10042017
<b>description</b>	flat gasket copper ED ø 19mm ID ø 13.5mm thickness 1.5mm for thread 1/4" Qty 1 pcs		

DIN-7603-C



<b>No.</b>	528501	<b>Ref. No.</b>	10505561
<b>description</b>	gasket copper ED ø 22mm ID ø 16mm thickness 3mm		

PTFE gaskets



<b>No.</b>	525609	<b>Ref. No.</b>	10505550
<b>description</b>	flat gasket PTFE ED ø 18mm ID ø 13.5mm thickness 2mm Qty 1 pcs		



<b>No.</b>	528314	<b>Ref. No.</b>	10505143
<b>description</b>	flat gasket PTFE ED ø 20mm ID ø 17mm thickness 2mm Qty 1 pcs suitable for Astoria/Azkoyen/Espresso/Wega		



<b>No.</b>	525611	<b>Ref. No.</b>	10502105A 10502109A
<b>description</b>	flat gasket PTFE ED ø 22mm ID ø 17mm thickness 2mm Qty 1 pcs		



<b>No.</b>	525610	<b>Ref. No.</b>	10502090A
<b>description</b>	flat gasket PTFE ED ø 35mm ID ø 30mm thickness 2mm Qty 1 pcs		



<b>No.</b>	525612	<b>Ref. No.</b>	10502020
<b>description</b>	flat gasket PTFE ED ø 56mm ID ø 42mm thickness 2mm Qty 1 pcs		

special gaskets

group gaskets

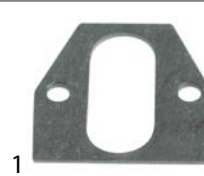

<b>No.</b>	528165	<b>Ref. No.</b>	10502130
<b>description</b>	group gasket L 76mm W 72mm thickness 2.5mm aperture 26x64mm hole distance 55mm		



## springs

### compression springs



1

<b>No.</b>	528503	<b>Ref. No.</b>	10402014
<b>description</b>	compression spring ø 10.5mm L 32mm wire gauge ø 1.4mm		

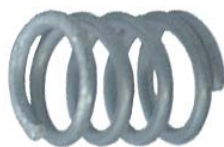

1

<b>No.</b>	529704	<b>Ref. No.</b>	10402043
<b>description</b>	compression spring ø 11.8mm L 16mm wire gauge ø 1.6mm steel		

## manometers



1

<b>No.</b>	541729	<b>Ref. No.</b>	10552015
<b>description</b>	manometer double scale ø 60mm pressure range 0-3 / 0-15bar connection on the backside thread 1/8" suitable for SANREMO		



1

<b>No.</b>	541730	<b>Ref. No.</b>	10552021A
<b>description</b>	manometer double scale ø 60mm pressure range 0-3 / 0-15bar connection on the backside thread 1/8" suitable for SANREMO		



1

<b>No.</b>	541731	<b>Ref. No.</b>	10552013A
<b>description</b>	manometer double scale ø 63mm pressure range 0-3 / 0-15bar connection on the backside thread 1/8" suitable for SANREMO		

## fastening material

### screws

#### countersunk screws



1

<b>No.</b>	560040	<b>Ref. No.</b>	10801032 10805303
<b>description</b>	countersunk screw thread M5 L 12mm WS 3 SS DIN 7991/ISO 10642 Qty 20 pcs intake hexagonal		