

Professionall

Solutii profesionale pentru echipamente profesionale



GAS COMPONENTS



ELECTRIC COMPONENTS



WATER TECHNOLOGY



MECHANICAL COMPONENTS



TOOLS



Spare parts suitable for

ROYAL





heating elements

heating elements for coffee machine

| | | | | |
|---|---|--------|-----------------|---------|
|  | | | | |
| 1 | No. | 417277 | Ref. No. | 5050009 |
| description | heating element 1300W 220V heating circuits 1 thread 1/4" L 97mm W 26mm H 26mm tube ø 6.5mm connection M4 immersion heater flange with thread WS 37 | | | |
| accessories for | 417277 | | | |
|  | No. | 528002 | Ref. No. | 2001010 |
| description | flat gasket PTFE ED ø 57mm ID ø 42mm thickness 3mm Qty 1 pcs equiv. no. 12001/W10470 suitable for | | | |

| | | | | |
|---|--|--------|-----------------|---------|
|  | | | | |
| 1 | No. | 417276 | Ref. No. | 5050100 |
| description | heating element 2000W 230V heating circuits 1 thread 1/4" L 145mm W 26mm H 28mm tube ø 8.3mm connection M4 immersion heater flange with thread WS 37 | | | |

| | | | | |
|---|---|--------|-----------------|---------|
|  | | | | |
| 1 | No. | 417273 | Ref. No. | 5050710 |
| description | heating element 2400W 230V heating circuits 2 mounting ø 42mm hole distance 74mm L 210mm W 35mm H 27mm hole ø 9.5mm thermostat sleeves ø 7mm length thermostat sleeves 195mm number of thermostat sleeves 1 thermostat sleeve bottom/centre tube ø 8.3mm connection M6 immersion heater 2 hole flange | | | |

| | | | | |
|---|--|--------|-----------------|---------|
|  | | | | |
| 1 | No. | 417275 | Ref. No. | 5050205 |
| description | heating element 2500W 230V heating circuits 2 thread 1/4" L 285mm W 35mm H 24mm tube ø 8.3mm thermostat sleeves ø 7mm length thermostat sleeves 160mm number of thermostat sleeves 1 thermostat sleeve centre connection M6 immersion heater connection length 30mm flange with thread WS 37 | | | |

| | | | | |
|---|---|--------|-----------------|---------|
|  | | | | |
| 1 | No. | 417274 | Ref. No. | 5050220 |
| description | heating element 3300W 230V heating circuits 2 thread 1/4" L 370mm W 35mm H 24mm tube ø 8.3mm thermostat sleeves ø 7mm length thermostat sleeves 160mm number of thermostat sleeves 1 thermostat sleeve centre connection M6 immersion heater flange with thread WS 37 | | | |

| | | | | |
|---|---|--------|-----------------|----------------------------|
|  | | | | |
| 1 | No. | 417272 | Ref. No. | 5050720 5050720+2001010 |
| description | heating element 3500W 230V heating circuits 2 mounting ø 42mm hole distance 74mm L 335mm W 35mm H 60mm L1 25mm L2 60mm L3 250mm H1 27mm H2 23mm hole ø 9.5mm tube ø 8.3mm thermostat sleeves ø 7mm length thermostat sleeves 195mm thermostat sleeve centre number of thermostat sleeves 1 connection M6 immersion heater 2 hole flange | | | |

| | | | | |
|--|---|--------|-----------------|---------|
|  | | | | |
| 1 | No. | 417270 | Ref. No. | 5050230 |
| description | heating element 4000W 230V heating circuits 2 thread 1/4" L 495mm W 35mm H 22mm tube ø 8.3mm thermostat sleeves ø 7mm length thermostat sleeves 160mm number of thermostat sleeves 1 thermostat sleeve centre connection M6 immersion heater flange with thread | | | |

| | | | | |
|--|--|--------|-----------------|---------|
|  | | | | |
| 1 | No. | 417271 | Ref. No. | 5050730 |
| description | heating element 5250-6250W 220-240V heating circuits 2 mounting ø 42mm hole distance 74mm L 515mm W 35mm H 60mm L1 25mm L2 60mm L3 430mm H1 27mm H2 23mm hole ø 9.5mm tube ø 8.3mm thermostat sleeves ø 7mm length thermostat sleeves 195mm thermostat sleeve centre number of thermostat sleeves 1 connection M6 immersion heater 2 hole flange | | | |

| | | | | |
|--|---|--------|-----------------|---------|
|  | | | | |
| 1 | No. | 417269 | Ref. No. | 5050740 |
| description | heating element 5500W 230V heating circuits 2 mounting ø 42mm hole distance 74mm L 655mm W 35mm H 50mm L1 25mm L2 60mm L3 570mm H1 27mm H2 23mm hole ø 9.5mm tube ø 8.3mm thermostat sleeves ø 7mm length thermostat sleeves 195mm number of thermostat sleeves 1 connection 2 immersion heater 2 hole flange | | | |

accessories

sealing washers

PTFE gaskets

| | | | | |
|---|---|--------|-----------------|---------|
|  | | | | |
| 1 | No. | 528022 | Ref. No. | 2001001 |
| description | flat gasket PTFE ED ø 52mm ID ø 41mm thickness 2mm size 1/4" Qty 1 pcs suitable for CARIMALI, FAEMA, MARZOCCO, PAVONI | | | |

| | | | | |
|---|---|--------|-----------------|---------|
|  | | | | |
| 1 | No. | 528002 | Ref. No. | 2001010 |
| description | flat gasket PTFE ED ø 57mm ID ø 42mm thickness 3mm Qty 1 pcs equiv. no. 12001/W10470 suitable for | | | |

electric components



thermostats

bi-metal thermostats

safety bi-metal thermostats



1

| | | | |
|--------------------|---|-----------------|---------|
| No. | 390690 | Ref. No. | 5013030 |
| description | bi-metal thermostat switch-off temp. 200°C 1NC 1-pole 10A connection F6.3 thread M4 mounting ø 16mm | | |

bi-metal thermostats



1

| | | | |
|--------------------|---|-----------------|---------|
| No. | 390323 | Ref. No. | 5013025 |
| description | bi-metal thermostat hole distance mm switch-off temp. 145°C 1NC 1-pole 16A connection F6.3 M4 | | |

control and safety thermostats

PRODIGY / FIRT

control thermostats

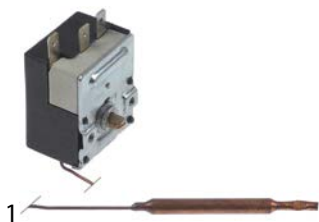

1

| | | | |
|--------------------|---|-----------------|---------|
| No. | 390691 | Ref. No. | 5013010 |
| description | thermostat t.max. 180°C 1-pole 1CO 16A probe ø 6mm probe L 70mm capillary pipe 360mm shaft ø 6x4.6mm shaft L 6mm shaft position upper rotation 270° | | |

various

safety thermostats



1

| | | | |
|--------------------|---|-----------------|---------|
| No. | 375494 | Ref. No. | 5013005 |
| description | safety thermostat switch-off temp. 155°C 2-pole 2NC 20A probe ø 6mm probe L 92mm capillary pipe 980mm capillary pipe isolated 500mm | | |

switches and momentary switches

rocker/momentary rocker switches

30x22mm



1

| | | | |
|--------------------|--|-----------------|---------|
| No. | 347207 | Ref. No. | 5003240 |
| description | rocker switch mounting measurements 30x22mm white 2NO 250V 20A illuminated 0-I connection male faston 6.3mm ambient temperature max. 120/55°C protection IP65 with rubber collar | | |



1

| | | | |
|--------------------|---|-----------------|---------|
| No. | 301001 | Ref. No. | 5003080 |
| description | rocker switch mounting measurements 30x22mm red 2NO 250V 16A illuminated 0-I connection male faston 6.3mm ambient temperature max. 125/55°C protection IP65 | | |

| | | | | |
|------------------------|---|--------|-----------------|---|
| accessories for | 301001 | | | |
| | No. | 301036 | Ref. No. | — |
| | protective cover internal size 30x22mm for rocker switch mounting measurements mm | | | |



1

| | | | |
|--------------------|---|-----------------|-----------------|
| No. | 347318 | Ref. No. | 5003010(Vapore) |
| description | momentary rocker switch mounting measurements 30x22mm red 2NO 250V 16A steam connection male faston 6.3mm ambient temperature max. 125/55°C protection IP40 | | |



1

| | | | |
|--------------------|---|-----------------|---------|
| No. | 346049 | Ref. No. | 5003040 |
| description | rocker switch mounting measurements 30x22mm red 2NO 250V 16A illuminated cup connection male faston 6.3mm ambient temperature max. 125/55°C protection IP40 | | |

push/momentary push switches

20.6x16.4mm





1

| | | | |
|--------------------|--|-----------------|---------|
| No. | 347205 | Ref. No. | 5003035 |
| description | push switch mounting measurements 20.6x16.4mm chrome 2NO 250V 16A connection male faston 6.3mm ambient temperature max. 85°C protection IP40 | | |



28.5x28.5mm

| | | | |
|---|---|-----------------|---------|
|  | | | |
| 1 | | | |
| No. | 345142 | Ref. No. | 5003230 |
| description | push switch mounting measurements 28.5x28.5mm red/green 2NO 250V 16A connection male faston 6.3mm ambient temperature max. 150°C protection IP40 with indicator | | |

| | | | |
|---|---|-----------------|---------|
|  | | | |
| 1 | | | |
| No. | 347206 | Ref. No. | 5003235 |
| description | push switch mounting measurements 28.5x28.5mm grey 2NO 250V 16A with indicator connection male faston 6.3mm ambient temperature max. 85°C mounting ø 24mm | | |



ø25mm

| | | | |
|---|---|-----------------|---------|
|  | | | |
| 1 | | | |
| No. | 345160 ¹ | Ref. No. | 5003210 |
| description | push switch mounting ø 25mm red 2NO 250V 16A illuminated connection male faston 6.3mm ambient temperature max. 85°C protection IP40 | | |

¹illuminated

toggle switches

| | | | |
|---|---|-----------------|---------|
|  | | | |
| 1 | | | |
| No. | 346520 | Ref. No. | 5003100 |
| description | toggle switch thread M12x0.75 2CO 250V 15A ON-OFF-ON male faston 6.3mm with neutral position t.max. 85/55°C | | |

| | | | |
|---|---|-----------------|-----------------|
|  | | | |
| 1 | | | |
| No. | 346519 | Ref. No. | 5003045 |
| description | toggle switch thread M12x0.75 2NO 250V 15A ON-OFF male faston 6.3mm | | |
| accessories for | 346519 | | |
|  | No. | 346525 | Ref. No. |
| | | | — |
| | protection cap L 23.5mm W 17.3mm protection cap rubber thread M11 | | |
|  | No. | 347197 | Ref. No. |
| | | | — |
| | bezel ON-OFF for toggle switch M12 | | |

microswitches

| | | | |
|---|---|-----------------|---------|
|  | | | |
| pin-plunger actuated | | | |
| M10 | | | |
| 1 | | | |
| No. | 347211 | Ref. No. | 5003301 |
| description | microswitch with plunger thread M10x0.75 250V 16A 1CO connection male faston 6.3mm ambient temperature max. 125°C | | |

| | | | |
|---|---|-----------------|---------|
|  | | | |
| 1 | | | |
| No. | 345325 | Ref. No. | 5003301 |
| description | microswitch with plunger thread M10x0.75 thread L 14mm 250V 10A 1CO connection male faston 6.3mm stroke 7.5mm mounting distance 22mm L 28mm ambient temperature max. 125°C type NR6K5 actuating force: 260g | | |

| | | | |
|--|--|-----------------|---------|
|  | | | |
| roller actuated | | | |
| roller 0° | | | |
| 1 | | | |
| No. | 345639 | Ref. No. | 5003310 |
| description | microswitch with roller plunger 230V 16A 1CO connection solder/screw connection L1 49mm ambient temperature max. 125°C thread L 14mm thread M10 mounting distance 25mm actuating force: 300g type MS15-1 | | |

rotary switches

| | | | |
|--|--|-----------------|---------|
|  | | | |
| BREMAS | | | |
| A1700 series | | | |
| 1 | | | |
| No. | 347198 ¹ | Ref. No. | 5005105 |
| description | rotary switch 2 0-1 sets of contacts 4 type CA0200004V 400V 20A shaft ø 5x5mm shaft L 19mm shaft square connection screw | | |

¹incl. rubber protective sleeve

| | | | |
|--|---|-----------------|---------|
|  | | | |
| 1 | | | |
| No. | 346100 | Ref. No. | 5005035 |
| description | rotary switch 3 1-0-2 sets of contacts 8 type CS0177412 400V 20A shaft ø 5x5mm shaft L 21mm shaft square connection screw | | |



A2500 series



1



| | | | |
|--------------------|---|-----------------|---------|
| No. | 346101 | Ref. No. | 5005040 |
| description | rotary switch 3 1-0-2 sets of contacts 8 type CS0257412 600V 32A shaft \varnothing 5x5mm shaft L 21mm shaft square connection screw | | |

KRAUS & NAIMER

rotary switches





1

| | | | |
|---|--|-----------------|-------------------------|
| No. | 347209 ¹ | Ref. No. | 5005020 5005025 |
| description | rotary switch 3 0-1-2 sets of contacts 6 type CA20-ATX12X018 400V 25A shaft \varnothing 22.5mm connection screw code 97/000400 marking I-3461*06 | | |
| accessories for | 347209 | | |
|  | No. | 347214 | Ref. No. 5005200 |
| | knob shaft \varnothing 6mm shaft L 20mm complete mounting \varnothing 22mm lever length 35mm | | |
|  | No. | 347215 | Ref. No. 5005210 |
| | knob complete 2 shaft \varnothing 6mm shaft L 20mm complete L 48mm mounting \varnothing 22mm W 48mm mounting distance 36mm | | |

¹incl. collar

1

| | | | |
|---|--|-----------------|-------------------------|
| No. | 347210 | Ref. No. | 5005028 |
| description | rotary switch sets of contacts 6 type CA25-AT09X016 490V 30A connection screw code I-3461*05 | | |
| accessories for | 347210 | | |
|  | No. | 347214 | Ref. No. 5005200 |
| | knob shaft \varnothing 6mm shaft L 20mm complete mounting \varnothing 22mm lever length 35mm | | |
|  | No. | 347215 | Ref. No. 5005210 |
| | knob complete 2 shaft \varnothing 6mm shaft L 20mm complete L 48mm mounting \varnothing 22mm W 48mm mounting distance 36mm | | |

accessories



1

| | | | |
|--------------------|--|-----------------|---------|
| No. | 347215 | Ref. No. | 5005210 |
| description | knob complete 2 shaft \varnothing 6mm shaft L 20mm complete L 48mm mounting \varnothing 22mm W 48mm mounting distance 36mm | | |



1

| | | | |
|--------------------|--|-----------------|---------|
| No. | 347214 | Ref. No. | 5005200 |
| description | knob shaft \varnothing 6mm shaft L 20mm complete mounting \varnothing 22mm lever length 35mm | | |

lamps

indicator lights

indicator lights (complete)

 \varnothing 10mm

with screw socket



1

| | | | |
|--------------------|--|-----------------|---------|
| No. | 359476 | Ref. No. | 5010030 |
| description | indicator light \varnothing 10mm 110/250V red connection male faston 6.3mm | | |



1

| | | | |
|--------------------|--|-----------------|---------|
| No. | 359475 | Ref. No. | 5010003 |
| description | indicator light \varnothing 10mm 125V green connection male faston 6.3mm | | |



 \varnothing 16mm

with plug-in socket









1

| | | | |
|--------------------|--|-----------------|---------|
| No. | 359474 | Ref. No. | 5010006 |
| description | indicator light \varnothing 16mm 230V green connection male faston 6.3mm | | |

| | | | |
|---|--|--------|-------------------|
| spare parts for | 359474 | | |
|  | No. | 345601 | Ref. No. — |
| | indicator lamp holder V \varnothing 11mm | | |
|  | No. | 359132 | Ref. No. — |
| | indicator lamp green 250V connection male faston 6.3mm protection IP54 ambient temperature max. 85°C | | |
|  | No. | 359247 | Ref. No. — |
| | indicator light lens \varnothing 12.2mm green | | |



| | | | |
|---|--|-----------------|-------------------|
|  | | | |
| 1 | | | |
| No. | 359472 | Ref. No. | 5010036 |
| description | indicator light ø 16mm 230V red connection male faston 6.3mm | | |
| spare parts for | 359472 | | |
| | No. | 345601 | Ref. No. — |
|  | indicator lamp holder V ø 11mm | | |
| | No. | 359130 | Ref. No. — |
|  | indicator lamp 230V clear connection male faston 6.3mm ø 8mm | | |
| | No. | 359245 | Ref. No. — |
|  | indicator light lens ø 12.2mm red | | |

| | | | |
|--|---|-----------------|-------------------|
|  | | | |
| 1 | | | |
| No. | 359473 | Ref. No. | 5010033 |
| description | indicator light ø 16mm 230V yellow connection male faston 6.3mm | | |
| spare parts for | 359473 | | |
| | No. | 345601 | Ref. No. — |
|  | indicator lamp holder V ø 11mm | | |
| | No. | 359130 | Ref. No. — |
|  | indicator lamp 230V clear connection male faston 6.3mm ø 8mm | | |

solid state relays

miscellaneous

| | | | |
|---|---|-----------------|---------|
|  | | | |
| 1 | | | |
| No. | 403541 | Ref. No. | 5012005 |
| description | solid state relay GEFRAN 1 phase 50A 480V 3-32VDC L 58mm W 45mm screw type GQ-50-48-D-1-3 | | |

relays

level relays

GICAR

| | | | |
|--|---|-----------------|---------|
|  | | | |
| 1 | | | |
| No. | 402103 | Ref. No. | 5030363 |
| description | level controller 230/240V voltage AC 50/60Hz connection F6.3 type NRL30/1E-2C/F | | |

| | | | |
|--|--|-----------------|---------|
|  | | | |
| 1 | | | |
| No. | 402234 | Ref. No. | 5030320 |
| description | level controller 230V voltage AC connection F6.3 type RL30/3ES/F/G | | |

electronics

PCBs

| | | | |
|--|------------------------|-----------------|---------|
|  | | | |
| 1 | | | |
| No. | 402235 | Ref. No. | 5029103 |
| description | display L 117mm W 45mm | | |

| | | | |
|--|------------------------|-----------------|---------|
|  | | | |
| 1 | | | |
| No. | 402246 | Ref. No. | 5029110 |
| description | display L 135mm W 44mm | | |

| | | | |
|---|------------------------|--------|-----------------|
|  | | | |
| 1 | No. | 402259 | Ref. No. |
| | | | 5029105 |
| description | display L 135mm W 44mm | | |

central units

| | | | |
|---|--|--------|-----------------|
|  | | | |
| 1 | No. | 402261 | Ref. No. |
| | | | 5030010 |
| description | central unit 230V 50/60Hz 5/10A type 30µZ R/E voltage AC | | |

| | | | |
|--|---|--------|---------------------|
|  | | | |
| 1 | No. | 402245 | Ref. No. |
| | | | 5030011 old version |
| description | central unit 230V 50/60Hz type 30µZ R/E | | |

| | | | |
|---|-------------------------------|--------|-----------------|
|  | | | |
| 1 | No. | 403926 | Ref. No. |
| | | | 5030011 |
| description | central unit kit 230V 50/60Hz | | |

| | | | |
|---|--|--------|-----------------|
|  | | | |
| 1 | No. | 402233 | Ref. No. |
| | | | 5030110 |
| description | control box 1-group for coffee machine 230V manual type DOS MAN 1GR NO TEA | | |

| | | | |
|--|--|--------|-----------------|
|  | | | |
| 1 | No. | 402232 | Ref. No. |
| | | | 5030115 |
| description | control box 2-group for coffee machine 230V manual type DOS MAN 2GR NO TEA | | |

| | | | |
|--|--|--------|-----------------|
|  | | | |
| 1 | No. | 402241 | Ref. No. |
| | | | 5030100 |
| description | control box 3-group for coffee machine 230V type 3d5 MAESTRO DELUXE 6T | | |

dosing electronics

GICAR

| | | | |
|--|--|--------|-----------------|
|  | | | |
| 1 | No. | 402262 | Ref. No. |
| | | | 5030120 |
| description | dosing electronics 2-group 230V 50/60Hz 2.1A type DELUXE | | |

| | | | |
|--|--|--------|-----------------|
|  | | | |
| 1 | No. | 402231 | Ref. No. |
| | | | 5030080 |
| description | dosing electronics 3-group 230V voltage AC 50/60Hz type 3d5 3GRCTZ XLC (SC) DPG 96 C | | |



keypads

keypad units

| | | | |
|---|---|-----------------|--------------------|
|  | | | |
| 1 | | | |
| No. | 402260 | Ref. No. | 5031380 5031410 |
| description | keypad unit buttons 1 white L 35mm W 26mm | | |

| | | | |
|---|--------------------------------------|-----------------|---------|
|  | | | |
| 1 | | | |
| No. | 402238 | Ref. No. | 5031340 |
| description | keypad unit buttons 4 L 135mm W 44mm | | |

| | | | |
|---|--------------------------------------|-----------------|---------|
|  | | | |
| 1 | | | |
| No. | 402239 | Ref. No. | 5031350 |
| description | keypad unit buttons 6 L 135mm W 44mm | | |

| | | | |
|---|--|-----------------|---------|
|  | | | |
| 1 | | | |
| No. | 402240 | Ref. No. | 5031333 |
| description | keypad unit buttons 6 L 135mm W 44mm with holder | | |

| | | | |
|---|-------------------------------------|-----------------|---------|
|  | | | |
| 1 | | | |
| No. | 402244 | Ref. No. | 5031011 |
| description | keypad unit buttons 6 L 88mm W 60mm | | |

| | | | |
|--|--|-----------------|---------|
|  | | | |
| 1 | | | |
| No. | 402236 | Ref. No. | 5031015 |
| description | keypad unit coffee machine buttons 5 L 88mm W 60mm | | |

| | | | |
|--|---|-----------------|---------|
|  | | | |
| 1 | | | |
| No. | 402237 | Ref. No. | 5031210 |
| description | keypad unit coffee machine Classica/Diadema 2-3-4 gr. buttons 2 L 88mm W 60mm | | |

| | | | |
|---|---|-----------------|---------|
|  | | | |
| 1 | | | |
| No. | 402258 | Ref. No. | 5031305 |
| description | keypad unit espresso machine DeLux/Imola/Marenello/Monza 2-3-4 gr. buttons 6 L 135mm W 44mm | | |

| | | | |
|--|--|-----------------|--------------------|
|  | | | |
| 1 | | | |
| No. | 402257 | Ref. No. | 5031280 5301280 |
| description | keypad unit espresso machine Lira 1-2-3-4 gr. buttons 6 L 135mm W 44mm | | |

→ electric components



solenoid valves

solenoid valves (water)

metal

LUCIFER

spare parts and accessories

valve bodies



1

| No. | 370061 | Ref. No. | BFC01 BFC02 |
|--------------------|--|----------|----------------|
| description | solenoid valve body LUCIFER-PARKER 3-ways outer cone | | |

ODE

solenoid valves steam (water)

21A1 series



1

| No. | 370093 | Ref. No. | 5020115 | |
|------------------------|--|----------|----------|---|
| description | solenoid valve 2/2-ways 230VAC body 25-F39 DN 2.5mm slide-on receptacle DIN -10 up to 140°C ODE type series 21A1 coil type BDA membranes FKM p max 14bar 50/60Hz silicone flange 32x32mm | | | |
| spare parts for | 370093 | | | |
| | No. | 371150 | Ref. No. | — |
| accessories for | 370093 | | | |
| | No. | 371090 | Ref. No. | — |
| | power socket plug type DIN 43650A screw | | | |

31A1 series



1

| No. | 370572 | Ref. No. | 5020055 |
|--------------------|--|----------|---------|
| description | solenoid valve brass 3-ways 230VAC DN 1.5mm -10 up to 140°C coil type ADA membranes ruby p max 15bar p min 0bar flange 32x32mm | | |

PARKER

spare parts and accessories

valve bodies



1

| No. | 370062 | Ref. No. | BFC01 BFC02 | |
|------------------------|---|----------|----------------|---|
| description | solenoid valve body PARKER 3-ways outer cone | | | |
| accessories for | 370062 | | | |
| | No. | 371029 | Ref. No. | — |
| description | solenoid coil PARKER 230VAC 9VA coil type ZB09 seat ø 14mm H 33mm W 34mm D 43mm | | | |
| | No. | 371030 | Ref. No. | — |
| description | solenoid coil 24VDC 12VA coil type ZB12 seat ø 14mm | | | |
| | No. | 371033 | Ref. No. | — |
| description | solenoid coil PARKER 230VAC 9VA coil type YB09 with cable seat ø 14mm | | | |
| | No. | 371036 | Ref. No. | — |
| description | solenoid coil 24VAC 9VA coil type ZB09 seat ø 14mm | | | |
| | No. | 371095 | Ref. No. | — |
| description | O-ring Viton thickness 1.78mm ID ø 6.07mm Qty 1 pcs | | | |
| | No. | 371100 | Ref. No. | — |
| description | O-ring silicone thickness 1.78mm ID ø 6.07mm Qty 1 pcs | | | |

pressure switches

for coffee machines

miscellaneous



1

| No. | 541690 | Ref. No. | 5006070 |
|--------------------|--|----------|---------|
| description | pressure control pressure range 1.1bar connection 1/4" 16A 1-pole type 250V pressure connection 1/4" | | |

electrodes



1

| No. | 401365 | Ref. No. | 4550005 |
|--------------------|--|----------|---------|
| description | level electrode 1/4" total length 172mm probe L 145mm insulated probe length 26mm connection male faston 6.3mm stainless steel ø 2.5mm | | |



equipment-specific units

for espresso machines

filter holders

filter holders standard

filter holder without spout



1

| | | | |
|--------------------|--|-----------------|-----|
| No. | 525975 | Ref. No. | N/A |
| description | filter holder suitable for BFC/ROYAL1 without outlet mounting \varnothing 83mm outlet 3/8" ID \varnothing 62mm wedge height 10mm wedge position horizontal number of wedges 2 lever inclined | | |



1

| | | | |
|--------------------|---|-----------------|-----|
| No. | 525976 | Ref. No. | N/A |
| description | filter holder suitable for BFC/ROYAL1/RANCILIO without outlet mounting \varnothing 82mm outlet 3/8" ID \varnothing 62mm wedge height 10mm wedge position horizontal number of wedges 2 lever straight | | |

filter holders short



1

| | | | |
|--------------------|---|-----------------|---------|
| No. | 526528 | Ref. No. | 4650100 |
| description | filter holder mounting \varnothing 82mm outlet 3/8" ID \varnothing 62mm handle M12x1.75 wedge height 10mm wedge position horizontal number of wedges 2 lever straight chrome-plated brass | | |



1

| | | | |
|--------------------|---|-----------------|---------|
| No. | 529050 | Ref. No. | 4650100 |
| description | filter holder mounting \varnothing 82mm outlet 3/8" ID \varnothing 62mm handle M12x1.75 wedge height 10mm wedge position horizontal number of wedges 2 lever straight chrome-plated brass | | |

accessories for

| | | | |
|---|---|-----------------|---|
| No. | 529045 | Ref. No. | — |
|  | handle \varnothing 35mm thread M12x1.75 thread L 15mm L 125mm black | | |



1

| | | | |
|--------------------|---|-----------------|---------|
| No. | 526527 | Ref. No. | 4650108 |
| description | filter holder mounting \varnothing 83mm outlet 3/8" ID \varnothing 62mm handle M12x1.75 wedge height 10mm wedge position horizontal number of wedges 2 lever inclined chrome-plated brass | | |

filters

for 1 cup



1

| | | | |
|--------------------|--|-----------------|-----|
| No. | 527631 | Ref. No. | N/A |
| description | coffee filter \varnothing 70mm mounting \varnothing 60.7mm H 17mm cups 1 amount of coffee 8g | | |



1

| | | | |
|--------------------|--|-----------------|---------|
| No. | 529011 | Ref. No. | 4630051 |
| description | coffee filter \varnothing 70mm mounting \varnothing 60mm H 24.5mm cups 1 amount of coffee 7g perforation \varnothing 0.4mm | | |

for 2 cups



1

| | | | |
|--------------------|---|-----------------|---------|
| No. | 529076 | Ref. No. | 4630052 |
| description | coffee filter \varnothing 70mm mounting \varnothing 60.8mm H 24.5mm cups 2 amount of coffee 14g ECONOMY | | |

blind filters



1

| | | | |
|--------------------|--|-----------------|---------|
| No. | 529023 | Ref. No. | 4630100 |
| description | blind filter \varnothing 70mm mounting \varnothing 60mm H 18mm | | |

brewing units

shower screens

flat



1

| | | | |
|--------------------|---|-----------------|---------|
| No. | 529084 | Ref. No. | 4630033 |
| description | shower screen \varnothing 52mm hole \varnothing 6.4mm | | |

with upstand



1

| | | | |
|--------------------|---|-----------------|---------|
| No. | 528417 | Ref. No. | 0520080 |
| description | shower screen \varnothing 58mm H 19mm | | |

filter holder gaskets

flat

with internal notch



1

| | | | |
|--------------------|--|-----------------|---------|
| No. | 527986 | Ref. No. | 0520090 |
| description | filter holder gasket D1 \varnothing 73.5mm D2 \varnothing 57.5mm H 8.5mm with inside notch Qty 1 pcs | | |



1

| | | | |
|--------------------|--|-----------------|---------|
| No. | 527987 | Ref. No. | 2002310 |
| description | filter holder gasket D1 \varnothing 73.5mm D2 \varnothing 57.5mm H 8mm with inside notch Qty 1 pcs | | |

brewing units with solenoid valve

components



1

| | | | |
|--------------------|---|-----------------|---------|
| No. | 527989 | Ref. No. | 0520096 |
| description | drain pipe \varnothing 20mm ID \varnothing 16.5mm L 28mm T1: 1/4" chrome-plated brass | | |



1

| | | | |
|--------------------|--------------------------------|-----------------|---------|
| No. | 527988 | Ref. No. | 0520095 |
| description | tap aerator M10x1 L 35mm WS 22 | | |

brewing units manual

components

drain units

drain pipes



1

| | | | |
|--------------------|---|-----------------|---------|
| No. | 527931 | Ref. No. | 0530060 |
| description | drain pipe thread 1/2" int. \varnothing 1 11.5mm int. \varnothing 2 15mm L 35.5mm WS 26 | | |



1

| | | | |
|--------------------|---|-----------------|---------|
| No. | 527937 | Ref. No. | 0530040 |
| description | drain pipe thread 1/2" T1: M30x1.5 L 72mm WS 36 | | |





1

| | | | |
|--------------------|--|-----------------|---------|
| No. | 528538 | Ref. No. | 0530060 |
| description | end piece thread 1/2" int. \varnothing 1 12mm int. \varnothing 2 15mm L 36mm chrome-plated brass WS 26 | | |



drain valves

| | | | |
|---|------------------------|-----------------|---------|
|  | | | |
| 1 | | | |
| No. | 527936 | Ref. No. | 0530043 |
| description | valve ED ø 16mm H 27mm | | |

| | | | |
|---|---|-----------------|---------|
|  | | | |
| 1 | | | |
| No. | 526002 | Ref. No. | 0530043 |
| description | valve support ø 16mm L 27mm brass shaft triangular D1 ø 10mm D2 ø 7mm | | |

tap aerators

| | | | |
|---|---|-----------------|---------|
|  | | | |
| 1 | | | |
| No. | 527932 | Ref. No. | 0530047 |
| description | tap aerator D1 ø 8mm D2 ø 15mm ID ø 6mm H 6mm brass | | |

gaskets

| | | | |
|---|--|-----------------|--------------------|
|  | | | |
| 1 | | | |
| No. | 529795 | Ref. No. | 0510140 0541070 |
| description | gasket D1 ø 13mm D2 ø 4mm thickness 4mm coffee machine | | |

| | | | |
|---|---|-----------------|---------|
|  | | | |
| 1 | | | |
| No. | 527945 | Ref. No. | 0530080 |
| description | gasket ED ø 16mm ID ø 8mm H 4mm for lever | | |

nozzle holders

| | | | |
|---|---|-----------------|---------|
|  | | | |
| 1 | | | |
| No. | 527949 | Ref. No. | 0520030 |
| description | nozzle holder thread M30x1.5 IT M16x1.5 IT 1 M6 ø 25.5mm int. ø 15mm int. ø 2 17mm L 66mm total length 80mm WS 36 chrome-plated brass | | |

springs

| | | | |
|--|--|-----------------|---------|
|  | | | |
| 1 | | | |
| No. | 527933 | Ref. No. | 0530045 |
| description | compression spring ø 14.2mm L 21mm wire gauge ø 1.8mm SS | | |

| | | | |
|--|--|-----------------|---------|
|  | | | |
| 1 | | | |
| No. | 527934 | Ref. No. | 0530030 |
| description | compression spring ø 14.2mm L 45mm wire gauge ø 1.5mm SS | | |

| | | | |
|--|---|-----------------|---------|
|  | | | |
| 1 | | | |
| No. | 527935 | Ref. No. | 0530095 |
| description | compression spring ø 14.6mm L 33mm wire gauge ø 2mm | | |

levers

| | | | |
|--|---|-----------------|---------|
|  | | | |
| 1 | | | |
| No. | 527943 | Ref. No. | 0530110 |
| description | lever L 70mm thread M8 shaft diameter 6x6mm | | |

camshafts

| | | | |
|--|--|-----------------|---------|
|  | | | |
| 1 | | | |
| No. | 527940 | Ref. No. | 0530070 |
| description | camshaft shaft ø 8mm shaft intake ø 6.2mm L 86.5mm W 20mm H 17mm thread M6 brass | | |

valves







| | | | |
|--|---|-----------------|-----------------|
|  | | | |
| 1 | | | |
| No. | 526008 | Ref. No. | 0530001 |
| description | valve group outflow L 54.3mm ED ø 16mm shaft ø 4.5mm brass | | |
| accessories for | 526008 | | |
| | No. | 526003 | Ref. No. |
| | | | — |
| |  compression spring ø 13.8mm L 54.5mm wire gauge ø 1.5mm windings 10 drain valve | | |

Table continues overleaf

| | | | | |
|---|---|--------|----------|---|
| accessories for | 526008 | | | |
|  | No. | 532550 | Ref. No. | — |
| | O-ring NBR 787/70 thickness 2.62mm ID ø 9.13mm Qty 10 pcs | | | |

| | | | | |
|---|--|--------|----------|---------|
| 1  | No. | 526007 | Ref. No. | 0530020 |
| description | valve group supply L 52.8mm ED ø 16mm shaft triangular | | | |

| | | | | |
|---|--------------------------|--------|----------|---------|
| 1  | No. | 527938 | Ref. No. | 0530020 |
| description | valve H 52.6mm ED ø 16mm | | | |

| | | | | |
|---|--------------------------|--------|----------|---------|
| 1  | No. | 527939 | Ref. No. | 0530001 |
| description | valve H 54.2mm ED ø 16mm | | | |

screw connections

| | | | | |
|--|------------------------------|--------|----------|---------|
| 1  | No. | 527944 | Ref. No. | 0530120 |
| description | cap nuts IT M6 ø 15mm L 22mm | | | |

| | | | | |
|---|---|--------|----------|---------|
| 1  | No. | 527942 | Ref. No. | 0530100 |
| description | screw connection thread 1/2" int. ø 1 10.8mm int. ø 2 15mm L 17mm WS 22 | | | |

| | | | | |
|---|--|--------|----------|---------|
| 1  | No. | 527941 | Ref. No. | 0530090 |
| description | screw connection thread M30x1.5 IT 1/2" L 39mm WS 26 | | | |

components

nozzles

with thread

| | | | | |
|---|---|--------|----------|---------|
| 1  | No. | 528486 | Ref. No. | 0520020 |
| description | nozzle bore ø 0.7mm thread M6x0.75 L 9mm WS 7 | | | |

miscellaneous

| | | | | |
|--|---------------------------------|--------|----------|---------|
| 1  | No. | 527948 | Ref. No. | 4001011 |
| description | protection cap for brewing unit | | | |

screw connections

| | | | | |
|--|--|--------|----------|---------|
| 1  | No. | 527270 | Ref. No. | 0520000 |
| description | end cap thread M16x1.5 ID ø 8.9mm L 21mm chrome-plated WS 22 | | | |

water dispersions

water dispersions

group 2

| | | | | |
|---|---|--------|----------|---------|
| 1  | No. | 529230 | Ref. No. | 0520070 |
| description | water distributor ø 30mm hole ø 2mm H 14mm ET M10x1 grooves 6 2mm brass 2 holes perforation ø 1.7mm | | | |



safety valves

safety valves

3/8"



1

| | | | |
|--------------------|--|-----------------|---------|
| No. | 527977 | Ref. No. | 3630030 |
| description | safety valve connection 3/8" triggering pressure 1.8bar approval CE 0036 | | |



1

| | | | |
|--------------------|--|-----------------|---------|
| No. | 527976 | Ref. No. | 3630025 |
| description | safety valve connection 3/8"-1/2" triggering pressure 1.8bar approval CE 0035 sealed | | |

expansion valves

with hose connection



1

| | | | |
|--------------------|---|-----------------|---------|
| No. | 529329 | Ref. No. | 3630140 |
| description | expansion valve adjustable T1: 3/8" ET hose ø 9.5mm BL 40mm total length 78.6mm | | |



1

| | | | |
|--------------------|---|-----------------|---------|
| No. | 527979 | Ref. No. | 3630140 |
| description | expansion valve T1: 3/8" ET hose ø 9.5mm L 58mm | | |

drain pans

drain pans



1

| | | | |
|--------------------|--|-----------------|---------|
| No. | 527946 | Ref. No. | 4008005 |
| description | drain pan L 69mm W 79mm H 54mm hose ø 14mm | | |

aerators and air bleeders



1

| | | | |
|--------------------|---|-----------------|---------|
| No. | 527981 | Ref. No. | 3630001 |
| description | aerator and air bleeder connection 1/4" | | |

boilers

heat exchangers

injector tubes



1

| | | | |
|--------------------|--|-----------------|---------|
| No. | 527951 | Ref. No. | 2510002 |
| description | injector pipe tube ø 8mm pipe length 100mm T1: 1/4" T2: 1/4" | | |



1

| | | | |
|--------------------|--|-----------------|---------|
| No. | 527952 | Ref. No. | 2510005 |
| description | injector pipe tube ø 8mm pipe length 140mm T1: 1/4" T2: 1/4" | | |

steam/water taps

steam/water taps

steam/water taps



1

| | | | |
|--------------------|--|-----------------|---------|
| No. | 527953 | Ref. No. | 3501030 |
| description | steam/water tap inlet 1/4" outlet 3/8" brass | | |

steam taps

steam taps (complete)



1

| | | | |
|--------------------|---|-----------------|---------|
| No. | 527954 | Ref. No. | 3501150 |
| description | steam tap mounting pos. external inlet 3/8" outlet 3/8" chrome-plated brass | | |

components

shafts



1

| | | | |
|--------------------|--|-----------------|---------|
| No. | 527959 | Ref. No. | 0540080 |
| description | shaft for steam-/water-tap \varnothing 14mm D1 \varnothing 11.5mm D2 \varnothing 7.5mm D3 \varnothing 5.8mm L 88mm brass | | |

bushes



1

| | | | |
|------------------------|--|-----------------|-----------------|
| No. | 526010 | Ref. No. | 0540060 |
| description | bush steam/water tap D1 \varnothing 10.5mm D2 \varnothing 9mm ID \varnothing 6.3mm H 4.6mm brass | | |
| accessories for | 526010 | | |
| | No. | 526005 | Ref. No. |
| | | | — |
| description | shaft steam tap \varnothing 14.8mm L 92.5mm thread M6 brass | | |

gaskets



1

| | | | |
|--------------------|--|-----------------|--------------------|
| No. | 527961 | Ref. No. | 0510162 0540090 |
| description | flat gasket copper ED \varnothing 21mm ID \varnothing 17.2mm thickness 1.5mm | | |



1

| | | | |
|--------------------|--|-----------------|---------|
| No. | 527970 | Ref. No. | 0541060 |
| description | flat gasket PTFE ED \varnothing 24mm ID \varnothing 18mm thickness 2mm Qty 1 pcs | | |



1

| | | | |
|--------------------|---|-----------------|---------|
| No. | 527960 | Ref. No. | 0540085 |
| description | gasket D1 \varnothing 12mm thickness 6mm for steam-/water-tap | | |



1

| | | | |
|--------------------|--|-----------------|--------------------|
| No. | 529795 | Ref. No. | 0510140 0541070 |
| description | gasket D1 \varnothing 13mm D2 \varnothing 4mm thickness 4mm coffee machine | | |



1

| | | | |
|--------------------|---|-----------------|---------|
| No. | 527972 | Ref. No. | 0541100 |
| description | gasket set D1 \varnothing 16mm ID \varnothing 7.8mm thickness 4mm rubber for steam-/water-tap | | |

springs



1

| | | | |
|--------------------|--|-----------------|---------|
| No. | 527958 | Ref. No. | 0540070 |
| description | compression spring \varnothing 10.5mm L 32mm wire gauge \varnothing 1.3mm for steam-/water-tap | | |



1

| | | | |
|--------------------|---|-----------------|---------|
| No. | 527968 | Ref. No. | 0541050 |
| description | compression spring \varnothing 12.5mm L 31mm wire gauge \varnothing 1.8mm | | |



1

| | | | |
|--------------------|--|-----------------|---------|
| No. | 527969 | Ref. No. | 0541055 |
| description | compression spring \varnothing 8mm L 21mm wire gauge \varnothing 0.4mm | | |

tap bodies



1

| | | | |
|--------------------|---|-----------------|---------|
| No. | 527962 | Ref. No. | 0540095 |
| description | body T1: M16x1 T2: 3/8" T3: 1/4" L 49mm | | |

washers



1

| | | | |
|--------------------|--|-----------------|---------|
| No. | 527955 | Ref. No. | 0540030 |
| description | plain washer ID \varnothing 6.1mm ED \varnothing 20mm thickness 1.6mm brass Qty 1 pcs for coffee machine tap | | |



screw connections



1

| | | | |
|--------------------|---|-----------------|---------|
| No. | 527956 | Ref. No. | 0540040 |
| description | screw connection T1: M16x1 L 61mm ID ø 11mm WS 26 brass | | |

steam/water pipes

steam pipes



1

| | | | |
|--------------------|--|-----------------|---------|
| No. | 527926 | Ref. No. | 2520530 |
| description | steam pipe thread 3/8" H 120mm L 50mm W 100mm tube ø 10mm SS | | |



1

| | | | |
|--------------------|---|-----------------|---------|
| No. | 527924 | Ref. No. | 2520512 |
| description | steam pipe thread 3/8" H 170mm W 100mm tube ø 10mm SS | | |



1

| | | | |
|--------------------|---|-----------------|---------|
| No. | 527925 | Ref. No. | 2520518 |
| description | steam pipe thread 3/8" H 170mm W 120mm tube ø 10mm SS | | |



1

| | | | |
|--------------------|---|-----------------|---------|
| No. | 527927 | Ref. No. | 2520550 |
| description | steam pipe thread 3/8" H 190mm W 100mm tube ø 10mm SS | | |



1

| | | | |
|--------------------|--|-----------------|---------|
| No. | 527928 | Ref. No. | 2520555 |
| description | steam pipe thread 3/8" H 250mm W 70mm tube ø 10mm SS | | |



1

| | | | |
|--------------------|---|-----------------|---------|
| No. | 527929 | Ref. No. | 2520580 |
| description | steam pipe thread 3/8" H 270mm L 70mm W 80mm tube ø 8mm brass | | |



1

| | | | |
|--------------------|---|-----------------|---------|
| No. | 527930 | Ref. No. | 2520590 |
| description | steam pipe thread 3/8" H 270mm L 70mm W 80mm tube ø 8mm brass | | |

nozzles for steam pipes



1

| | | | |
|--------------------|---|-----------------|---------|
| No. | 527964 | Ref. No. | 0540150 |
| description | nozzle thread M9x0.75 ø 13mm L 21mm 4 holes bore ø 1.5mm SS | | |

nozzles for water pipes

gaskets



1

| | | | |
|--------------------|--|-----------------|---------|
| No. | 527965 | Ref. No. | 0540210 |
| description | flat gasket rubber ED ø 21mm ID ø 15mm thickness 3mm Qty 1 pcs | | |

components



| | | |
|--------------------|--|-------------------------|
| 1 | No. 527967 | Ref. No. 0540220 |
| description | screw connection for flow regulator thread M22x1 L 16mm ø 23.5mm ID ø 20mm | |

tap aerators



| | | |
|--------------------|--|-------------------------|
| 1 | No. 527966 | Ref. No. 0540215 |
| description | tap aerator D1 ø 18.8mm D2 ø 20.8mm H 12mm | |

water pipes



| | | |
|--------------------|---|-------------------------|
| 1 | No. 527920 | Ref. No. 2520007 |
| description | water pipe thread 1/4" ø 23.5mm L 105mm WS 17 brass | |



| | | |
|--------------------|-------------------------------------|-------------------------|
| 1 | No. 526614 | Ref. No. 2520035 |
| description | water pipe thread 3/8" L 75mm WS 22 | |



| | | |
|--------------------|---|-------------------------|
| 1 | No. 527921 | Ref. No. 2520015 |
| description | water pipe thread 3/8" ø 23.5mm L 112mm WS 22 brass | |



| | | |
|--------------------|---|-------------------------|
| 1 | No. 527923 | Ref. No. 2520130 |
| description | water pipe thread 3/8" ø 23.5mm L 75mm WS 22 SS | |



| | | |
|--------------------|--|-------------------------|
| 1 | No. 527922 | Ref. No. 2520020 |
| description | water pipe thread 3/8" ø 23.5mm L 86mm WS 22 brass | |

accessories

bushes



| | | |
|--------------------|---|-------------------------|
| 1 | No. 527971 | Ref. No. 0541125 |
| description | bush D1 ø 7.8mm D2 ø 15mm H 21.5mm brass ID ø 6mm | |



| | | |
|--------------------|--|-------------------------|
| 1 | No. 529705 | Ref. No. 0540110 |
| description | bush D1 ø 8.3mm D2 ø 12mm H 6mm brass ID ø 7mm | |

springs



| | | |
|--------------------|---|-------------------------|
| 1 | No. 527963 | Ref. No. 0540100 |
| description | compression spring ø 12mm L 16.5mm wire gauge ø 1.5mm steel for steam/water pipes | |

tube handles



| | | |
|--------------------|------------------------------------|-------------------------|
| 1 | No. 528625 | Ref. No. 4005040 |
| description | tube handle L 35mm rubber ID ø 8mm | |



union nuts



1

| | | | |
|--------------------|--|-----------------|---------|
| No. | 529706 | Ref. No. | 0540135 |
| description | union nut thread 3/8" L 21mm hole ø 12.5mm brass | | |

various taps



1

| | | | |
|--------------------|--|-----------------|---------|
| No. | 527975 | Ref. No. | 3501160 |
| description | water tap inlet 3/8" outlet 3/8" shaft 6.5x6.5 shaft L 19mm brass for cup warmer | | |

fine filters

fine filters



1

| | | | |
|--------------------|---------------------------------|-----------------|---------|
| No. | 528946 | Ref. No. | 0520010 |
| description | fine filter pipe ø 8.5mm H 22mm | | |

intake valves

intake valves



1

| | | | |
|--------------------|--|-----------------|---------|
| No. | 527957 | Ref. No. | 4650140 |
| description | intake valve brass with expansion valve inlet 3/8" outlet 1/4" | | |

accessories

bolts



1

| | | | |
|--------------------|---------------------------|-----------------|---------|
| No. | 526504 | Ref. No. | 0510142 |
| description | bolt ø 7mm L 47.5mm brass | | |

bushes



1

| | | | |
|--------------------|---|-----------------|---------|
| No. | 526501 | Ref. No. | 0510148 |
| description | bush for lever D1 ø 12mm D2 ø 14.6mm int. ø 1.7mm H 6.7mm brass | | |

gaskets



1

| | | | |
|--------------------|---|-----------------|---------|
| No. | 527995 | Ref. No. | 0510186 |
| description | gasket ED ø 15mm seat ø 6mm H 5mm overall height 10mm | | |

gasket supports



1

| | | | |
|--------------------|--|-----------------|---------|
| No. | 527997 | Ref. No. | 0510166 |
| description | gasket support D1 ø 7.3mm D2 ø 13mm H 20mm brass | | |



1

| | | | |
|--------------------|--|-----------------|---------|
| No. | 527996 | Ref. No. | 0510184 |
| description | gasket support D1 ø 8.6mm D2 ø 17mm int. ø 1.6mm int. ø 2.15mm H 9mm brass | | |

levers



1

| | | | |
|--------------------|---------------------------|-----------------|---------|
| No. | 526500 | Ref. No. | 0510152 |
| description | lever ø 12mm L 48mm brass | | |

miscellaneous



1

| | | | |
|--------------------|--|-----------------|---------|
| No. | 526503 | Ref. No. | 0510120 |
| description | piston D1 ø 9mm D2 ø 16mm int. ø 1.13mm H 13mm brass | | |

screw connections



1

| | | | |
|--------------------|--|-----------------|---------|
| No. | 526502 | Ref. No. | 0510114 |
| description | screw connection thread 1/4" L 28mm WS 24 ID ø 7mm brass | | |

| | | | |
|---|---|-----------------|---------|
|  | | | |
| 1 | | | |
| No. | 527998 | Ref. No. | 0510105 |
| description | screw connection thread 1/4" T1: 3/8" L 32mm WS 21 ID ø 7mm brass | | |

| | | | |
|---|--|-----------------|---------|
|  | | | |
| 1 | | | |
| No. | 527999 | Ref. No. | 0510150 |
| description | screw connection thread 3/8" L 19mm ø 20mm WS 21 ID ø 12.2mm | | |

level glasses

level glasses

gaskets

| | | | |
|---|--|-----------------|---------|
|  | | | |
| 1 | | | |
| No. | 529408 | Ref. No. | 2003010 |
| description | gasket D1 ø 16mm D2 ø 10mm H 8mm water level glass | | |

balls

| | | | |
|---|--------------------|-----------------|---------|
|  | | | |
| 1 | | | |
| No. | 527947 | Ref. No. | 4012010 |
| description | ball ø 6mm plastic | | |

level glass pipes

| | | | |
|---|--|-----------------|---------|
|  | | | |
| 1 | | | |
| No. | 527990 | Ref. No. | 4580010 |
| description | water level tube ø 11mm H 140mm ID ø 8mm marking Min/Max red | | |

pipes

pipes

| | | | |
|---|------------------------------|-----------------|---------|
|  | | | |
| 1 | | | |
| No. | 527950 | Ref. No. | 2502006 |
| description | aspiration tube ø 8mm L 98mm | | |

non-return valves

complete

| | | | |
|--|--|-----------------|---------|
|  | | | |
| 1 | | | |
| No. | 527978 | Ref. No. | 3630120 |
| description | non-return valve inlet 3/8" outlet 3/8" L 38mm | | |

screw connections

reducers

| | | | |
|--|---|-----------------|---------|
|  | | | |
| 1 | | | |
| No. | 527980 | Ref. No. | 3510730 |
| description | reducer T1: 1/8" T2: 1/2" int. ø 1 5mm int. ø 2 14mm L 64mm brass | | |

T-pieces

| | | | |
|---|--|-----------------|---------|
|  | | | |
| 1 | | | |
| No. | 527985 | Ref. No. | 3510010 |
| description | T-piece thread 1/4" T1: 1/2" T2: 1/2" int. ø 1 11.5mm int. ø 2 10/14mm L 46mm brass for boiler | | |

angle pieces

| | | | |
|---|--|-----------------|---------|
|  | | | |
| 1 | | | |
| No. | 527984 | Ref. No. | 3510005 |
| description | angle piece T1: 1/2" T2: 1/2" int. ø 1 11.5mm int. ø 2 10/14mm L 48mm brass for boiler | | |

| | | | |
|---|--|-----------------|---------|
|  | | | |
| 1 | | | |
| No. | 527983 | Ref. No. | 3510004 |
| description | angle piece T1: 1/4" T2: 3/8" int. ø 1 6mm int. ø 2 8mm L 25mm brass | | |

| | | | |
|---|---|-----------------|---------|
|  | | | |
| 1 | | | |
| No. | 527982 | Ref. No. | 3510003 |
| description | angle piece T1: 3/8" T2: 3/8" int. ø 1 8.2mm int. ø 2 10mm L 25mm brass | | |



for dishwashers

washing and rinsing systems



1

| | | | |
|--------------------|-----------------------------|-----------------|---------|
| No. | 520706 | Ref. No. | 3530005 |
| description | screw cap thread 1/4" WS 17 | | |

knobs

steam/water taps

steam/water taps



1

| | | | |
|--------------------|--|-----------------|---------|
| No. | 111274 | Ref. No. | 4001010 |
| description | turning handle ø 41mm thread M18 black | | |

knob dial plates



1

| | | | |
|--------------------|----------------------------|-----------------|---------|
| No. | 111275 | Ref. No. | 4001020 |
| description | symbol steam ø 32mm L 28mm | | |



1

| | | | |
|--------------------|----------------------------|-----------------|---------|
| No. | 111276 | Ref. No. | 4001025 |
| description | symbol water ø 32mm L 28mm | | |

accessories



1

| | | | |
|--------------------|---------------------------|-----------------|---------|
| No. | 528762 | Ref. No. | 0540020 |
| description | cotter pin ø 1.8mm L 17mm | | |

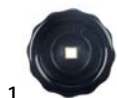

1

| | | | |
|--------------------|---|-----------------|---------|
| No. | 541691 | Ref. No. | 4001015 |
| description | star handle shaft 7x7mm ø 64mm L 24mm black thermoplastic | | |

handles and hand wheels

cone handles



1

| | | | |
|--------------------|---|-----------------|---------|
| No. | 111092 | Ref. No. | 4001005 |
| description | cone handle thread M8 ø 25mm L 41mm black | | |

star handles

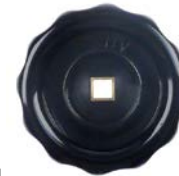

1

| | | | |
|--------------------|---|-----------------|---------|
| No. | 541691 | Ref. No. | 4001015 |
| description | star handle shaft 7x7mm ø 64mm L 24mm black thermoplastic | | |

fittings for catering equipment

drain taps

accessories



1

| | | | |
|--------------------|--|-----------------|---------|
| No. | 540222 | Ref. No. | 2002120 |
| description | O-ring EPDM thickness 2.62mm ID ø 47.3mm Qty 1 pcs | | |

gaskets

O-rings

EPDM



1

| | | | |
|--------------------|--|-----------------|---------|
| No. | 510177 | Ref. No. | 0541120 |
| description | O-ring EPDM thickness 1.78mm ID ø 7.66mm Qty 1 pcs | | |



1

| | | | |
|--------------------|--|-----------------|---------|
| No. | 530293 | Ref. No. | 0510164 |
| description | O-ring EPDM thickness 1.78mm ID ø 8.73mm Qty 1 pcs | | |

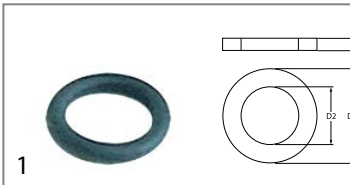

| | | | |
|--------------------|---|-----------------|---------|
| No. | 529412 | Ref. No. | 0541130 |
| description | O-ring EPDM thickness 2.62mm ID ø 10.78mm Qty 1 pcs | | |

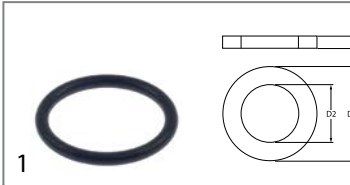

| | | | |
|--------------------|---|-----------------|---------|
| No. | 532453 | Ref. No. | 0520040 |
| description | O-ring EPDM thickness 2.62mm ID ø 21.89mm Qty 1 pcs | | |

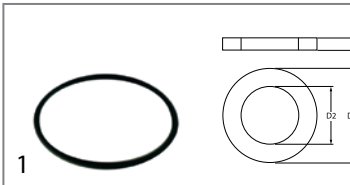

| | | | |
|--------------------|--|-----------------|---------|
| No. | 540222 | Ref. No. | 2002120 |
| description | O-ring EPDM thickness 2.62mm ID ø 47.3mm Qty 1 pcs | | |

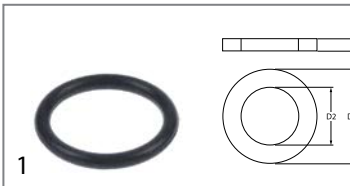

| | | | |
|--------------------|---|-----------------|---------|
| No. | 527991 | Ref. No. | 0510182 |
| description | O-ring EPDM thickness 2mm ID ø 14.5mm Qty 1 pcs | | |



| | | | |
|--------------------|--|-----------------|---------|
| No. | 361311 | Ref. No. | 0540050 |
| description | O-ring EPDM thickness 2mm ID ø 6mm Qty 1 pcs for type N6 | | |

silicone

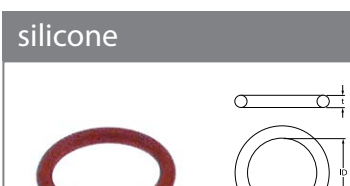

| | | | |
|--------------------|--|-----------------|---------|
| No. | 528516 | Ref. No. | 0540140 |
| description | O-ring silicone thickness 1mm ID ø 6mm Qty 1 pcs | | |

Viton



| | | | |
|--------------------|---|-----------------|---------|
| No. | 528687 | Ref. No. | 0510144 |
| description | O-ring Viton thickness 1.78mm ID ø 3.69mm Qty 1 pcs | | |

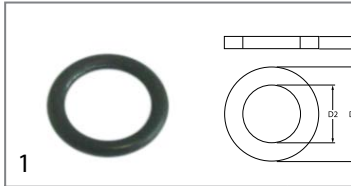

| | | | |
|--------------------|--|-----------------|---------|
| No. | 528291 | Ref. No. | 0540130 |
| description | O-ring Viton thickness 2.62mm ID ø 11.91mm Qty 1 pcs | | |

sealing washers

rubber gaskets



| | | | |
|--------------------|--|-----------------|---------|
| No. | 527965 | Ref. No. | 0540210 |
| description | flat gasket rubber ED ø 21mm ID ø 15mm thickness 3mm Qty 1 pcs | | |

copper gaskets

DIN-7603-A



| | | | |
|--------------------|--|-----------------|--------------------|
| No. | 527961 | Ref. No. | 0510162 0540090 |
| description | flat gasket copper ED ø 21mm ID ø 17.2mm thickness 1.5mm | | |



| | | | |
|--------------------|--|-----------------|---------|
| No. | 527994 | Ref. No. | 0510112 |
| description | flat gasket copper ED ø 25mm ID ø 19.3mm thickness 1.5mm | | |

DIN-7603-C





| | | | |
|--------------------|---|-----------------|---------|
| No. | 529360 | Ref. No. | 2004005 |
| description | gasket copper ED ø 26.1mm ID ø 21mm thickness 2.1mm for thread 1/2" | | |





PTFE gaskets

| | | | |
|---|--|-----------------|---------|
|  | | | |
| 1 | | | |
| No. | 526679 | Ref. No. | 0510190 |
| description | flat gasket PTFE ED ø 18mm ID ø 13mm thickness 2mm Qty 1 pcs | | |

| | | | |
|---|--|-----------------|---------|
|  | | | |
| 1 | | | |
| No. | 527993 | Ref. No. | 0510190 |
| description | flat gasket PTFE ED ø 18mm ID ø 13mm thickness 2mm Qty 1 pcs | | |

| | | | |
|---|---|-----------------|---------|
|  | | | |
| 1 | | | |
| No. | 528314 | Ref. No. | 0540120 |
| description | flat gasket PTFE ED ø 20mm ID ø 17mm thickness 2mm Qty 1 pcs suitable for Astoria/Azkoyen/Espressa/Wega | | |

| | | | |
|---|--|-----------------|---------|
|  | | | |
| 1 | | | |
| No. | 526013 | Ref. No. | 0520001 |
| description | flat gasket PTFE ED ø 22mm ID ø 17mm thickness 2mm Qty 1 pcs | | |

| | | | |
|---|--|-----------------|---------|
|  | | | |
| 1 | | | |
| No. | 527970 | Ref. No. | 0541060 |
| description | flat gasket PTFE ED ø 24mm ID ø 18mm thickness 2mm Qty 1 pcs | | |

| | | | |
|---|--|-----------------|---------|
|  | | | |
| 1 | | | |
| No. | 528683 | Ref. No. | 0530050 |
| description | flat gasket PTFE ED ø 26mm ID ø 21mm thickness 2mm Qty 1 pcs suitable for GAGGIA, SPAZIALE | | |

| | | | |
|---|--|-----------------|---------|
|  | | | |
| 1 | | | |
| No. | 526014 | Ref. No. | 0520050 |
| description | flat gasket PTFE ED ø 35mm ID ø 30mm thickness 2mm Qty 1 pcs | | |

| | | | |
|---|--|-----------------|---------|
|  | | | |
| 1 | | | |
| No. | 528022 | Ref. No. | 2001001 |
| description | flat gasket PTFE ED ø 52mm ID ø 41mm thickness 2mm size 1¼" Qty 1 pcs suitable for CARIMALI, FAEMA, MARZOCCO, PAVONI | | |

| | | | |
|---|---|-----------------|---------|
|  | | | |
| 1 | | | |
| No. | 528002 | Ref. No. | 2001010 |
| description | flat gasket PTFE ED ø 57mm ID ø 42mm thickness 3mm Qty 1 pcs equiv. no. 12001/W10470 suitable for | | |

Viton gaskets

| | | | |
|---|--|-----------------|---------|
|  | | | |
| 1 | | | |
| No. | 528476 | Ref. No. | 0530010 |
| description | flat gasket Viton ED ø 13mm ID ø 4mm thickness 4mm Qty 1 pcs | | |

special gaskets

group gaskets

| | | | |
|--|--|-----------------|---------|
|  | | | |
| 1 | | | |
| No. | 528165 | Ref. No. | 2001310 |
| description | group gasket L 76mm W 72mm thickness 2.5mm aperture 26x64mm hole distance 55mm | | |

springs

compression springs

| | | | |
|--|--|-----------------|---------|
|  | | | |
| 1 | | | |
| No. | 527958 | Ref. No. | 0540070 |
| description | compression spring ø 10.5mm L 32mm wire gauge ø 1.3mm for steam-/water-tap | | |

| | | | |
|--|---|-----------------|---------|
|  | | | |
| 1 | | | |
| No. | 527968 | Ref. No. | 0541050 |
| description | compression spring ø 12.5mm L 31mm wire gauge ø 1.8mm | | |

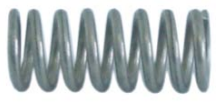
| | | | |
|---|---|-----------------|---------|
|  | | | |
| 1 | | | |
| No. | 528493 | Ref. No. | 0510110 |
| description | compression spring ø 12.6mm L 30mm wire gauge ø 1.9mm | | |

| | | | |
|---|---|-----------------|---------|
|  | | | |
| 1 | | | |
| No. | 527963 | Ref. No. | 0540100 |
| description | compression spring ø 12mm L 16.5mm wire gauge ø 1.5mm steel for steam/water pipes | | |

| | | | |
|---|--|-----------------|---------|
|  | | | |
| 1 | | | |
| No. | 527933 | Ref. No. | 0530045 |
| description | compression spring ø 14.2mm L 21mm wire gauge ø 1.8mm SS | | |

| | | | |
|--|--|-----------------|---------|
|  | | | |
| 1 | | | |
| No. | 527934 | Ref. No. | 0530030 |
| description | compression spring ø 14.2mm L 45mm wire gauge ø 1.5mm SS | | |

| | | | |
|---|---|-----------------|---------|
|  | | | |
| 1 | | | |
| No. | 527935 | Ref. No. | 0530095 |
| description | compression spring ø 14.6mm L 33mm wire gauge ø 2mm | | |

| | | | |
|---|--|-----------------|---------|
|  | | | |
| 1 | | | |
| No. | 527969 | Ref. No. | 0541055 |
| description | compression spring ø 8mm L 21mm wire gauge ø 0.4mm | | |

| | | | |
|---|--|-----------------|---------|
|  | | | |
| 1 | | | |
| No. | 527992 | Ref. No. | 0510160 |
| description | compression spring ø 8mm L 32mm wire gauge ø 0.5mm | | |

manometers

| | | | |
|--|---|-----------------|---------|
|  | | | |
| 1 | | | |
| No. | 541685 | Ref. No. | 4551014 |
| description | manometer double scale ø 63mm pressure range 0-2.5 / 0-15bar connection on the backside thread 1/8" | | |

| | | | |
|--|---|-----------------|---------|
|  | | | |
| 1 | | | |
| No. | 541686 | Ref. No. | 4551017 |
| description | manometer double scale ø 63mm pressure range 0-3 / 0-15bar connection on the backside thread 1/8" | | |

| | | | |
|--|--|-----------------|--------------------|
|  | | | |
| 1 | | | |
| No. | 541687 | Ref. No. | 4551035 4551045 |
| description | manometer ø 41mm pressure range 0-15bar thread 1/8" marking 7-8 connection on the backside with capillary pipe | | |

| | | | |
|--|---|-----------------|--------------------|
|  | | | |
| 1 | | | |
| No. | 541688 | Ref. No. | 4551037 4551047 |
| description | manometer ø 41mm pressure range 0-3bar thread 1/8" marking 2 connection on the backside with capillary pipe | | |

| | | | |
|--|---|-----------------|---------|
|  | | | |
| 1 | | | |
| No. | 541200 | Ref. No. | 4551022 |
| description | manometer ø 52mm pressure range 0 up to 3bar connection on the backside marking 0.7-1 thread 1/8" | | |



| | | | |
|---|--|-----------------|---------|
|  | | | |
| 1 | | | |
| No. | 541201 | Ref. No. | 4551025 |
| description | manometer ø 53.5mm pressure range 0 up to 16bar connection on the backside thread 1/8" | | |

| | | | |
|---|--|-----------------|---------|
|  | | | |
| 1 | | | |
| No. | 541693 | Ref. No. | 4551040 |
| description | manometer ø 63mm pressure range 0 up to 2.5bar marking 1 up to 1.2 connection 1/8" | | |

dosing pumps

membrane dosing pumps

self-priming

LANG

spare parts

| | | | |
|---|--|-----------------|---------|
|  | | | |
| 1 | | | |
| No. | 361311 | Ref. No. | 0540050 |
| description | O-ring EPDM thickness 2mm ID ø 6mm Qty 1 pcs for type N6 | | |

hoses

industrial hoses

PTFE hoses

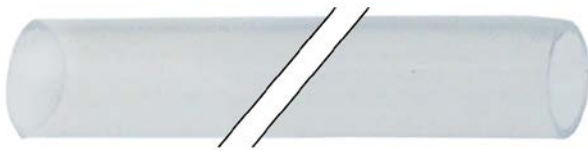
| | | | |
|---|-----------------------------------|-----------------|---------|
|  | | | |
| 1 | | | |
| No. | 527919 | Ref. No. | 4010200 |
| description | hose ED ø 12mm ID ø 10mm L 1m PFA | | |

fittings, hose and pipe connectors

fittings

double nipples

| | | | |
|--|--|-----------------|---------|
|  | | | |
| 1 | | | |
| No. | 520164 | Ref. No. | 3510710 |
| description | double nipple nickel-plated brass thread 1/4" - 3/8" Qty 1 pcs | | |

angle pieces

| | | | |
|--|--|-----------------|---------|
|  | | | |
| 1 | | | |
| No. | 520824 | Ref. No. | 3510009 |
| description | angle piece thread 1/8" ET - 1/8" IT nickel-plated brass | | |

T-pieces

stainless steel

| | | | |
|--|---|-----------------|---------|
|  | | | |
| 1 | | | |
| No. | 520710 | Ref. No. | 3510014 |
| description | T-piece thread 1/4" ET - 1/4" ET - 1/4" ET stainless steel L 49mm | | |

hose connectors

brass

| | | | |
|--|---|-----------------|---------|
|  | | | |
| 1 | | | |
| No. | 520673 | Ref. No. | 3520030 |
| description | hose connector brass straight thread 1/2" hose ø 14mm Qty 1 pcs | | |

valves and tank inlets

ball valves

universal

mini ball valves



1

| | | | |
|--------------------|---|-----------------|---------|
| No. | 520722 | Ref. No. | 3501001 |
| description | ball valve connection 1/4" IT - 1/4" ET DN8 total length 39mm chrome-plated brass | | |

fastening material

screws

cylinder head bolts

DIN 912/ISO 4762



1

| | | | |
|--------------------|--|-----------------|---------|
| No. | 560316 | Ref. No. | 1103210 |
| description | cylinder head bolt thread M8 thread L 25mm WS 6 SS Qty 20 pcs DIN 912/ISO 4762 | | |

nuts

hexagonal nuts

hexagonal nuts inch thread



1

| | | | |
|--------------------|---|-----------------|---------|
| No. | 503042 | Ref. No. | 0510146 |
| description | nut thread 3/8" H 6mm brass WS 22 Qty 1 pcs | | |

washers

washers

miscellaneous



1

| | | | |
|--------------------|--|-----------------|---------|
| No. | 527955 | Ref. No. | 0540030 |
| description | plain washer ID 6.1mm ED 20mm thickness 1.6mm brass Qty 1 pcs for coffee machine tap | | |

fasteners

cotter pins



1

| | | | |
|--------------------|-------------------------|-----------------|---------|
| No. | 528762 | Ref. No. | 0540020 |
| description | cotter pin 1.8mm L 17mm | | |

screw caps



1

| | | | |
|--------------------|-----------------------------|-----------------|---------|
| No. | 520706 | Ref. No. | 3530005 |
| description | screw cap thread 1/4" WS 17 | | |



1

| | | | |
|--------------------|-----------------------------|-----------------|---------|
| No. | 520705 | Ref. No. | 3530022 |
| description | screw cap thread 1/8" WS 16 | | |