

Professionall

Solutii profesionale pentru echipamente profesionale



GAS COMPONENTS



ELECTRIC COMPONENTS



WATER TECHNOLOGY



MECHANICAL COMPONENTS



TOOLS

Spare parts suitable for

RETIGO



heating elements

immersion heating elements

miscellaneous



1

No.	420360	Ref. No.	AX24-0008 AX24-0008+AX24-0002 EX24-0008	
description	heating element 12000W 230V heating circuits 3 L 330mm W 42mm H 65mm number of thermostat sleeves 1 thermostat sleeves ø 3.5mm length thermostat sleeves 80mm thermostat sleeve eccentric, clinging tube ø 8.4mm hole distance 65/77mm hole ø 8mm connection M4 flange immersion heater flange width 83mm flange length 95mm			
For models:	B1011b, B1221b, B2011b, B2021b, O1011b, O1221b, O2011b, O2021b			
accessories for	420360			
	No.	520580	Ref. No.	AX24-0002
	gasket rubber L 96mm W 84mm thickness 5mm hole ø 7mm hole distance 65x78mm			



1

No.	417542	Ref. No.	AX24-0006 AX24-0006+AX24-0002	
description	heating element 3x3000W 230V heating circuits 3 L 305mm W 68mm H 40mm number of thermostat sleeves 1 thermostat sleeves ø 3.3mm length thermostat sleeves 970mm thermostat sleeve upper right tube ø 8.5mm hole distance 77x67mm hole ø 7.9mm connection screw immersion heater flange width 95mm flange length 83mm with gasket			
For models:	B611b, O611b			
accessories for	417542			
	No.	520580	Ref. No.	AX24-0002
	gasket rubber L 96mm W 84mm thickness 5mm hole ø 7mm hole distance 65x78mm			



1

No.	419143	Ref. No.	EX24-0006	
description	heating element 9000W 230V heating circuits 3 L 305mm W 45mm H 65mm number of thermostat sleeves 1 thermostat sleeves ø 2.5mm length thermostat sleeves 90mm hole distance 65x78mm hole ø 8mm connection length 33mm connection M4 rectangular flange immersion heater			
accessories for	419143			
	No.	520580	Ref. No.	AX24-0002
	gasket rubber L 96mm W 84mm thickness 5mm hole ø 7mm hole distance 65x78mm			

heating elements for convection



1

No.	417545	Ref. No.	AX00-0007 AX00-0007+AX00-0008	
description	heating element 16000W 230V heating circuits 3 ID ø 380mm ED ø 430mm L 460mm H 98mm L1 45mm W1 187mm H1 18mm H2 80mm flange length 210mm flange width 24mm connection screw connection length 90mm tube ø 8.5mm convection heating element hole ø 7.6mm rectangular flange combi-steamer			
For models:	B1011b, B1011i, B1221b, B1221i, B2011b, B2011i, O1011b, O1011i, O1221b, O1221i, O2011b, O2011i			
accessories for	417545			
	No.	521127	Ref. No.	AX00-0008
	gasket L 210mm W 24mm thickness 2mm for heating element			



1

No.	417546	Ref. No.	AX00-0018	
description	heating element 29000W 230V heating circuits 6 ID ø 430mm ED ø 530mm L 530mm H 130mm L1 20mm W1 100mm H1 21mm H2 150mm flange length 130mm flange width 90mm hole distance 55mm connection screw connection length 85mm tube ø 8.5mm convection heating element hole ø 7.6mm rectangular flange combi-steamer			
For models:	B2021b, B2021i, O2021b, O2021i			



No.	417544	Ref. No.	AX00-0005 AX00-0005+AX00-0008
description	heating element 3x3000W 230V heating circuits 3 ID ø 375mm ED ø 400mm L 455mm H 200mm L1 45mm W1 160mm H1 20mm H2 110mm flange length 210mm flange width 25mm hole distance 30mm connection screw connection length 90mm tube ø 8.5mm convection heating element hole ø 7.6mm rectangular flange combi-steamer		
For models:	B611b, B611i, O611b, O611i		
accessories for	417544		
	No.	521127	Ref. No. AX00-0008
gasket L 210mm W 24mm thickness 2mm for heating element			



No.	417541	Ref. No.	AX00-0016 AX00-0016+AX00-0017
description	heating element 4800W 230V heating circuits 3 ID ø 205mm ED ø 250mm L 290mm H 45mm L1 45mm W1 95mm H1 5mm H2 30mm flange length 110mm flange width 20mm hole distance 35mm connection screw connection length 100mm tube ø 6.4mm convection heating element rectangular flange combi-steamer		
For models:	B623i, O623i		

accessories

flange gaskets



No.	551258	Ref. No.	AX00-0020
description	gasket L 130mm W 88mm D1 ø 7mm D2 ø 11mm 12 holes thickness 2mm for combi-steamer suitable for 417546		
For models:	B2021b, B2021i, O2021b, O2021i		

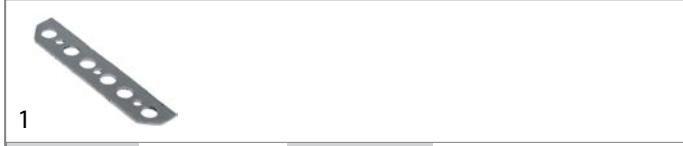

No.	521072	Ref. No.	AX00-0017
description	gasket L 112mm W 22mm D1 ø 10mm D2 ø 5.5mm graphite thickness 2mm for heating element suitable for RETIGO		
For models:	B623i, O623i		



No.	521127	Ref. No.	AX00-0008
description	gasket L 210mm W 24mm thickness 2mm for heating element		
For models:	B1011b, B1011i, B1221b, B1221i, B2011b, B2011i, B611b, B611i, O1011b, O1011i, O1221b, O1221i, O2011b, O2011i, O611b, O611i		



No.	520580	Ref. No.	AX24-0002
description	gasket rubber L 96mm W 84mm thickness 5mm hole ø 7mm hole distance 65x78mm		
For models:	B1011b, B1221b, B2011b, B2021b, B611b, O1011b, O1221b, O2011b, O2021b, O611b		

thermostats

control and safety thermostats

JUMO

safety thermostats



No.	390922	Ref. No.	EA04-0011
description	safety thermostat switch-off temp. 140°C 1-pole 1CO 16A probe ø 5mm probe L 96mm capillary pipe 990mm capillary pipe isolated 880mm gland nut probe copper		
For models:	B1011b, B1221b, B2011b, B2021b, B611b, O1011b, O1221b, O2011b, O2021b, O611b		

1

No.	390923	Ref. No.	EA04-0012
description	safety thermostat switch-off temp. 365°C temperature range°C 1-pole 1CO 16A probe ø 4mm probe L 107mm capillary pipe 1190mm capillary pipe isolated 1015mm gland nut shaft ømm screw connection M14x1		
For models:	B1011b, B1011i, B1221b, B1221i, B2011b, B2011i, B2021b, B2021i, B611b, B611i, B623i, O1011b, O1011i, O1221b, O1221i, O2011b, O2011i, O2021b, O2021i, O611b, O611i, O623i		

23x19mm

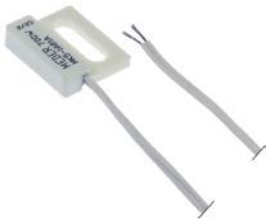

1

No.	347948	Ref. No.	EA01-0001
description	magnetic switch L 23mm W 19mm 1NC connection cable cable length 700mm 700W		

switches and momentary switches

magnetic switches

23x14mm

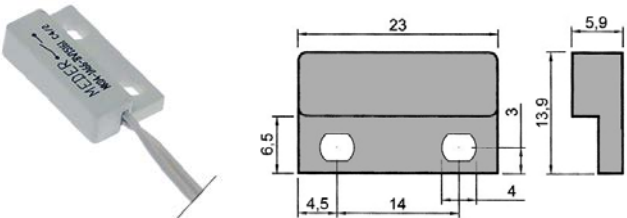

1

No.	347995	Ref. No.	EA01-0015
description	magnetic switch L 23mm W 14mm 1NO 180V 0.5A P max. 10W connection cable cable length 500mm		
For models:	B1011b, B1011i, B611b, B611i, B623i, O1011b, O1011i, O611b, O611i, O623i		

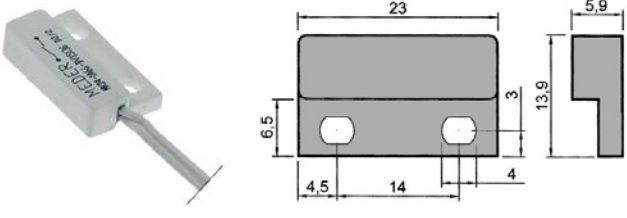

1

No.	347994	Ref. No.	EA01-0015
description	magnetic switch L 23mm W 14mm 1NO 180V 0.5A P max. 10W connection cable cable length 700mm		

lamps

screw-on/push-on fit

halogen lamp

for socket G4 / G6.35 / G9



1

No.	357193	Ref. No.	EA13-0100
description	halogen lamp socket G4 12V 20W temp.-resist. 300°C OSRAM HALOSTAR OVEN		



1

No.	359599	Ref. No.	EA13-0100
description	halogen lamp socket G4 12V 20W temp.-resist. 500°C		
For models:	B1011b, B1011i, B1221b, B1221i, B2011b, B2011i, B2021b, B2021i, B611b, B611i, B623i, O1011b, O1011i, O1221b, O1221i, O2011b, O2011i, O2021b, O2021i, O611b, O611i, O623i		

oven lamps



producer-specific oven lamps

RETIGO





1

No.	357183	Ref. No.	AX07-0002
description	gasket graphite ø 37mm ID ø 31mm thickness 1.5mm for bulb socket		
accessories for	357183		
No.	357182	Ref. No.	AX07-0001
description	lamp glass ø 37mm thickness 3mm		

			
1			
No.	357182	Ref. No.	AX07-0001
description	lamp glass ø 37mm thickness 3mm		
accessories for	357182		
	No.	357183	Ref. No. AX07-0002
	gasket graphite ø 37mm ID ø 31mm thickness 1.5mm for bulb socket		

			
1			
No.	359922	Ref. No.	EA13-0101
description	lamp socket with 2 hole fixing 25V socket G4 connection cable 140mm ø 17mm H 10mm mounting distance 11.5mm cable material silicone		
For models:	B1011b, B1011i, B1221b, B1221i, B2011b, B2011i, B2021b, B2021i, B611b, B611i, B623i, O1011b, O1011i, O1221b, O1221i, O2011b, O2011i, O2021b, O2021i, O611b, O611i, O623i		

			
1			
No.	680000	Ref. No.	AX07-0005 AX07-0006
description	gasket rubber ø 92mm ID ø 58mm thickness 7.6mm cavity lighting suitable for RETIGO		
For models:	B1011b, B1011i, B1221b, B1221i, B2011b, B2011i, B2021b, B2021i, B611b, B611i, B623i, O1011b, O1011i, O1221b, O1221i, O2011b, O2011i, O2021b, O2021i, O611b, O611i, O623i		

			
1			
No.	680001	Ref. No.	AX07-0004
description	lamp glass ø 69mm thickness 2.9mm		
For models:	B1011b, B1011i, B1221b, B1221i, B2011b, B2011i, B2021b, B2021i, B611b, B611i, B623i, O1011b, O1011i, O1221b, O1221i, O2011b, O2011i, O2021b, O2021i, O611b, O611i, O623i		

			
1			
No.	359922	Ref. No.	EA13-0101
description	lamp socket with 2 hole fixing 25V socket G4 connection cable 140mm ø 17mm H 10mm mounting distance 11.5mm cable material silicone		
For models:	B1011b, B1011i, B1221b, B1221i, B2011b, B2011i, B2021b, B2021i, B611b, B611i, B623i, O1011b, O1011i, O1221b, O1221i, O2011b, O2011i, O2021b, O2021i, O611b, O611i, O623i		

lamps			
halogen lamps			
for socket G4 / G6.35 / G9			
			
1			
No.	357193	Ref. No.	EA13-0100
description	halogen lamp socket G4 12V 20W temp.-resist. 300°C OSRAM HALOSTAR OVEN		

			
1			
No.	359599	Ref. No.	EA13-0100
description	halogen lamp socket G4 12V 20W temp.-resist. 500°C		
For models:	B1011b, B1011i, B1221b, B1221i, B2011b, B2011i, B2021b, B2021i, B611b, B611i, B623i, O1011b, O1011i, O1221b, O1221i, O2011b, O2011i, O2021b, O2021i, O611b, O611i, O623i		

alarm devices

loudspeakers

			
1			
No.	350208	Ref. No.	AA11-9903
description	loudspeaker ø 50mm built-in depth 15mm 80hm 0.5W connection plug cable length 1360mm		

			
1			
No.	350209	Ref. No.	AA11-9904
description	loudspeaker ø 50mm built-in depth 15mm 80hm 0.5W connection plug cable length 1740mm		

			
1			
No.	350207	Ref. No.	AA11-9902
description	loudspeaker ø 50mm built-in depth 16mm 80hm 0.5W connection plug cable length 340mm		



			
1			
No.	350211	Ref. No.	EA13-0151
description	loudspeaker ø 50mm built-in depth 16mm 8Ohm 0.5W connection soldering connection cable lengthmm		
For models:	B1011b, B1011i, B1221b, B1221i, B2011b, B2011i, B2021b, B2021i, B611b, B611i, B623i, O1011b, O1011i, O1221b, O1221i, O2011b, O2011i, O2021b, O2021i, O611b, O611i, O623i		

			
1			
No.	380976	Ref. No.	EA02-0003
description	power contactor resistive load 32A 230VAC (AC3/400V) 18A/7.5kW main contacts 3NO auxiliary contacts 1NO/1NC connection screw connection		

contactors

TELEMECANIQUE (Schneider Electric)

power contactors

			
1			
No.	381010	Ref. No.	EA02-0002
description	power contactor resistive load 20A 230VAC (AC3/400V) 6A/2.2kW main contacts 2x3NO auxiliary contacts 2x1NO connection screw connection type LC2K0610P7		
For models:	O1011b, O1011i, O1221b, O1221i, O2011b, O2011i, O2021b, O2021i, O611b, O611i		

			
1			
No.	380979	Ref. No.	EA02-0004
description	power contactor resistive load 40A 230VAC (AC3/400V) 25A/11kW main contacts 3NO auxiliary contacts 1NO/1NC connection screw connection type LC1D25P7		
For models:	B1011b, B1011i, B611b, B611i, O1011b, O1011i, O611b, O611i		

			
1			
No.	380965	Ref. No.	EA02-0001
description	power contactor resistive load 20A 230VAC (AC3/400V) 6A/2.2kW main contacts 3NO auxiliary contacts 1NO connection screw connection type LC1K0610P7+		
For models:	B623i, O623i		

			
1			
No.	380982	Ref. No.	EA02-0006
description	power contactor resistive load 80A 230VAC (AC3/400V) 50A/22kW main contacts 3NO auxiliary contacts 1NO/1NC connection screw connection type LC1D50P7		
For models:	B1221b, B1221i, B2011b, B2011i, B2021b, B2021i, O1221b, O1221i, O2011b, O2011i, O2021b, O2021i		



solid state relays

CELDUC



1

No.	402974	Ref. No.	EA02-0203 EA02-203
description	solid state relay CELDUC 2 phase 50A 24-600V 10-30VDC L 58mm W 45mm plug screw type SOB965660		
For models:	B1011b, B1011i, B1221b, B1221i, B2011b, B2011i, B2021b, B2021i, B611b, B611i, B623i, O1011b, O1011i, O1221b, O1221i, O2011b, O2011i, O2021b, O2021i, O611b, O611i, O623i		

heat-conducting foils



1

No.	403355	Ref. No.	EA02-0204
description	heat-conducting foil L 37mm W 37mm		

relays

plug-in/print relays

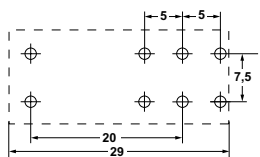

1

No.	380333	Ref. No.	EA01-0104	
description	print relay 230VAC 2CO at 250V 8A connection pins raster size 5mm FINDER manif. no. 40.52.8.230.0000 95.65/95.75			
accessories for	380333			
	No.	380340	Ref. No.	—
	relay socket dimensions 62x36x15mm 250V voltage AC 10A Italiana Relè manif. no. ZMEM/5			
	No.	380505	Ref. No.	—
	relay socket 2CO 40.52 dimensions 81.9x15.5x75mm 250V voltage AC 10A FINDER manif. no. 95.95.3			
	No.	381181	Ref. No.	—
	relay socket 2-pole 40.51/40.52/40.61 connection screw clamp dimensions 15.8x78.6mm 250V voltage AC 10A FINDER manif. no. 95.75			

relay sockets

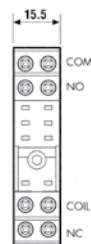
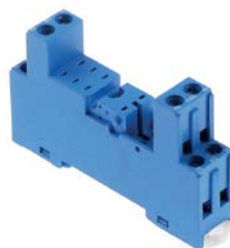

1

No.	381241	Ref. No.	EA13-0103
description	relay socket DIN rail connection screw dimensions 80x46x15mm 300V voltage AC 10A FINDER manif. no. 95.85.3 95.85.3		

transformers

toroidal core transformers



1

No.	403333	Ref. No.	EA13-0010
description	transformer primary 230VAC secondary 11.5VAC 20VA connection cable 200mm 50Hz type toroid temperature restriction 120°C ambient temperature max. 40°C		
For models:	B623i, O623i		



1

No.	403336	Ref. No.	EA13-0011
description	transformer primary 230VAC secondary 11.5VAC 40VA connection cable 200mm 50Hz		
For models:	B1011b, B1011i, B611b, B611i, O1011b, O1011i, O611b, O611i		

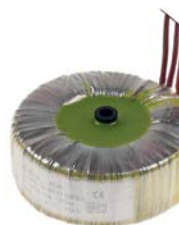

1

No.	403340	Ref. No.	EA13-0009
description	transformer primary 230VAC secondary 11.5VAC 63VA connection cable 200mm 50Hz type toroid		
For models:	B1221b, B1221i, B2011b, B2011i, B2021b, B2021i, O1221b, O1221i, O2011b, O2011i, O2021b, O2021i		



encapsulated transformers

with screw connection



1

No.	403352	Ref. No.	EA13-0008
description	transformer primary 230VAC secondary 17VAC 20VA secondary 1.17A connection screw 50-60Hz type 704077 DIN rail temperature restriction 125°C ambient temperature max. 40°C		
For models:	B1011b, B1011i, B1221b, B1221i, B2011b, B2011i, B2021b, B2021i, B611b, B611i, B623i, O1011b, O1011i, O1221b, O1221i, O2011b, O2011i, O2021b, O2021i, O611b, O611i, O623i		

probes

producer-specific probes

probes



1

No.	378348	Ref. No.	EA10-0007
description	temperature probe Pt100 cable silicone probe -100 up to 450°C cable -50 up to +180°C connection plug thread M10x1.5 probe ø6x30mm cable length 1.5m		



1

No.	378350	Ref. No.	EA10-0006
description	temperature probe Pt100 cable silicone probe -100 up to 450°C cable -50 up to +180°C connection plug thread probe ø4.5x25mm cable length 1.5m		



1

No.	381239	Ref. No.	EA10-0104
description	temperature probe thermocouple K (NiCr-Ni) cable PTFE probe -50 up to 1150°C cable -40 up to +250°C connection coded plug thread probe ø2x4mm cable length 1.5m		
For models:	B1011b, B1011i, B1221b, B1221i, B2011b, B2021b, B611b, B611i, B623i, O1011b, O1011i, O1221b, O1221i, O2011b, O2021b, O611b, O611i, O623i		



1

No.	381240	Ref. No.	EA10-0105
description	temperature probe thermocouple K (NiCr-Ni) cable PTFE probe -50 up to 1150°C cable -40 up to +250°C connection coded plug thread probe ø2x7mm cable length 2m		
For models:	B2011b, B2011i, B2021b, B2021i, O2011b, O2011i, O2021b, O2021i		



1

No.	381238	Ref. No.	EA10-0103
description	temperature probe thermocouple K (NiCr-Ni) cable silicone probe -50 up to 1150°C cable -50 up to +180°C connection coded plug thread probe ø1.9x140mm cable length 1.4m		
For models:	B1011b, B1011i, B1221b, B1221i, B2011b, B2011i, B2021b, B2021i, B611b, B611i, B623i, O1011b, O1011i, O1221b, O1221i, O2011b, O2011i, O2021b, O2021i, O611b, O611i, O623i		

core probes



1

No.	378349 ¹	Ref. No.	EA10-0069
description	core temperature probe Pt100 cable PTFE probe -40 up to +250°C cable -40 up to +250°C connection coded plug probe ø4.5x125mm thread M12x1.75 cable length 1m handle ø 14mm handle length 58mm		

¹multipoint probe



1

No.	378359	Ref. No.	EA10-0055
description	core temperature probe Pt100 cable PTFE probe -40 up to +250°C cable -40 up to +250°C connection coded plug probe ø4x115mm thread M12x1.75 cable length 1.5m handle ø 14mm handle length 58mm		

1



No.	378677	Ref. No.	EA10-0058
description	core temperature probe Pt100 cable PTFE probe -40 up to +250°C cable -40 up to +250°C connection coded plug probe ø4x125mm thread M12x1.75 cable length 0.8m handle ø 14mm handle length 58mm		

1



No.	381237	Ref. No.	EA10-0111 EA10-0116
description	core temperature probe thermocouple K (NiCr-Ni) cable PTFE probe -40 up to +250°C cable -40 up to +250°C connection coded plug probe ø3.9x170mm thread M16x2 cable length 1.4m handle ømm handle length 50mm		
For models:	O1011b, O1011i, O611b, O611i, O623i		

1



No.	381234 ¹	Ref. No.	EA10-0113 EA10-0118
description	core temperature probe thermocouple K (NiCr-Ni) cable PTFE probe -40 up to +250°C cable -40 up to +250°C connection coded plug probe ø3.9x170mm thread M16x2 cable length 1.4m handle ømm handle length 50mm		
For models:	B1011b, B1011i, B611b, B611i, B623i		

1



No.	381235 ¹	Ref. No.	EA10-0119
description	core temperature probe thermocouple K (NiCr-Ni) cable PTFE probe -40 up to +250°C cable -40 up to +250°C connection coded plug probe ø3.9x170mm thread M16x2 cable length 1.8m handle ømm handle length 50mm		

¹multipoint probe

¹multipoint probe





1

No.	381236	Ref. No.	EA10-0117
description	core temperature probe thermocouple K (NiCr-Ni) cable PTFE probe -40 up to +250°C cable -40 up to +250°C connection coded plug probe ø3.9x170mm thread M16x2 cable length 2.1m handle ømm handle length 50mm		



1

No.	403937	Ref. No.	EA14-0041
description	display combi-steamer L 95mm W 72mm		



1

No.	404012	Ref. No.	XC10-2100
description	display combi-steamer Orange FreeScale 2011 L 17mm W 13mm model XC10-2100 with control H 50mm type orange		
For models:	O1011b, O1011i, O1221b, O1221i, O2011b, O2011i, O2021b, O2021i, O611b, O611i, O623i		

electronics

frequency converters

accessories



1

No.	403356	Ref. No.	EA16-0041
description	braking resistor for frequency converter L 78mm W 29mm H 16mm 20-60W cable length 170mm VW3TR342150RJ 150Ohm		
For models:	B1011b, B1011i, B1221b, B1221i, B2011b, B2011i, B2021b, B2021i, B611b, B611i		

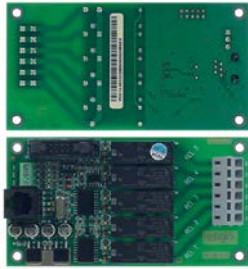

1

No.	403936	Ref. No.	EA14-0032
description	electronic controller for cleaning system L 112mm W 60mm		

PCBs



1

No.	404013	Ref. No.	XC10-2000
description	display combi-steamer Blue FreeScale2011 L 170mm W 130mm suitable for RETIGO model XC10-2000-10 with control H 50mm type blue		
For models:	B1011b, B1011i, B1221b, B1221i, B2011b, B2011i, B2021b, B2021i, B611b, B611i, B623i		

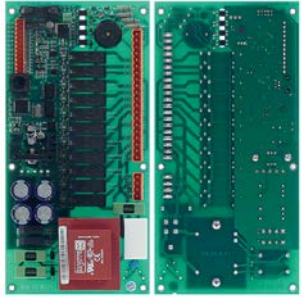

1

No.	403938	Ref. No.	EA14-0043
description	power PCB combi-steamer L 230mm W 115mm		



1

No.	404014	Ref. No.	EA14-0080
description	relay PCB combi-steamer B1011/B2011 L 200mm W 115mm model RP20B.15 with ribbon cable H 30mm		
For models:	B1011b, B1011i, B1221b, B1221i, B2011b, B2011i, B2021b, B2021i, B611b, B611i, B623i, O1011b, O1011i, O1221b, O1221i, O2011b, O2011i, O2021b, O2021i, O611b, O611i, O623i		

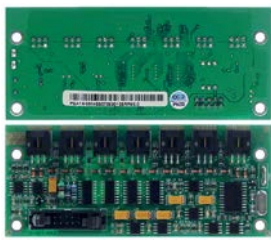



1

No.	404029	Ref. No.	EA14-0014
description	relay PCB combi-steamer L 112mm W 47mm		



1

No.	372018	Ref. No.	EA12-0050
description	solenoid valve single straight 230VAC inlet 3/4" outlet 14mm DN10 EATON (INVENSYS) flow regulating valve outlet flow regulating valve inlet white		
spare parts for	372018		
	No.	371122	Ref. No. —
solenoid valve filter ø 19mm H 10mm suitable for MÜLLER			
	No.	371131	Ref. No. —
solenoid coil 230VAC			



1

No.	372025	Ref. No.	EA12-0056
description	solenoid valve triple straight 230VAC inlet 3/4" outlet 11.5mm DN10 EATON (INVENSYS)		
For models:	B1011b, B1011i, B1221b, B1221i, B2011b, B2011i, B2021b, B2021i, B611b, B611i, O1221b, O1221i, O2011b, O2011i, O2021b, O2021i		

RPE

reducers

outlet side



1

No.	371247	Ref. No.	EA12-0303
description	reducer RPE flow rate 1-1.25l/min white		
For models:	B1011b, B1011i, B1221b, B1221i, B2011b, B2021b, B2021i, B611b, B611i, O1011b, O1011i, O1221b, O1221i, O2011b, O2021b, O2021i, O611b, O611i		

electrodes



1

No.	403295	Ref. No.	AC24-0101
description	level electrode M16x1 total length 205mm probe L 148mm insulated probe length 8mm connection 3-wire cable length 40mm		



1

No.	403353	Ref. No.	AC24-0602
description	level electrode push-in total length 225mm probe L 185mm insulated probe length 170mm triple connection bullet connector ø 15mm level suitable for RETIGO for 611/1011/1221/2011 edition boiler		
For models:	B1011b, B1221b, B2011b, B2021b, B611b, O1011b, O1221b, O2011b, O2021b, O611b		

solenoid valves

solenoid valves (water)

ROBERTSHAW/INVENSYS

medium temperature: 90°C 90°C 60°C
 ambient temperature: 60°C 25°C 60°C
 duty cycle: 40% 100% 100%



1

No.	372021	Ref. No.	EA12-0050
description	solenoid valve double straight 230VAC inlet 3/4" outlet 11.5mm DN10 EATON (INVENSYS)		
For models:	B1011b, B1011i, B611b, B611i, B623i, O1011b, O1011i, O1221b, O1221i, O2011b, O2011i, O2021b, O2021i, O611b, O611i, O623i		



1

No.	372003	Ref. No.	EA12-0051
description	solenoid valve single straight 230VAC inlet 3/4" outlet 10mm DN10 EATON (INVENSYS)		
For models:	O623i		



fans

axial fans

import



1

No.	601909 ¹	Ref. No.	ZA21-0007
description	axial fan L 119mm W 119mm H 38mm 220-240 50/60Hz 31/29W bearing ball bearing connection male faston 2.8mm		
For models:	B1011b, B1011i, B1221b, B1221i, B2011b, B2011i, B2021b, B2021i, B611b, B611i, B623i, O1011b, O1011i, O1221b, O1221i, O2011b, O2011i, O2021b, O2021i, O611b, O611i, O623i		

¹with ball bearings

hot air motors

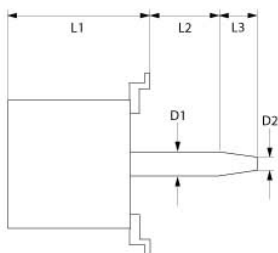

1

No.	499311	Ref. No.	AA11-0016 EA11-0014 EA11-14
description	fan motor 440V 3 phase 50Hz 0.3kW 1410rpm speeds 1 L1 130mm L2 22mm L3 38mm M10 1.2/0.7A at 50Hz 1410rpm D1 ø 17mm D2 ø 13.5mm		
For models:	B1011b, B1011i, B1221b, B1221i, B2011b, B2011i, B2021b, B2021i, B611b, B611i, O1011b, O1011i, O1221b, O1221i, O2011b, O2011i, O2021b, O2021i, O611b, O611i		



1

No.	602002	Ref. No.	AX09-0004
description	fan wheel D1 ø 175mm H1 38.5mm blades 9 D2 ø 8mm D3 ø 8mm H2 10mm H3 12mm		
For models:	B623i, O623i		



1

No.	602000	Ref. No.	AX09-0006
description	fan wheel D1 ø 320mm H1 110mm blades 12 D2 ø 13mm D3 ø 16.4mm H2 12mm H3 18mm		
For models:	B1221b, B1221i, B2021b, B2021i, O1221b, O1221i, O2021b, O2021i		



1

No.	602001	Ref. No.	AX09-0001
description	fan wheel D1 ø 320mm H1 83mm blades 12 D2 ø 13mm D3 ø 16.4mm H2 12mm H3 18mm		
For models:	B1011b, B1011i, B2011b, B2011i, B611b, B611i, O1011b, O1011i, O2011b, O2011i, O611b, O611i		



1

No.	551259	Ref. No.	AX00-0006
description	gasket motor shaft gasket ID ø 16.5mm ED ø 29mm thickness 4.2mm		
For models:	B1011b, B1011i, B1221b, B1221i, B2011b, B2011i, B2021b, B2021i, B611b, B611i, O1011b, O1011i, O1221b, O1221i, O2011b, O2011i, O2021b, O2021i, O611b, O611i		



1

No.	551261	Ref. No.	AX00-0011
description	gasket motor shaft gasket ID ø 8.5mm ED ø 20mm		
For models:	B623i, O623i		



1

No.	694684	Ref. No.	EA05-0201
description	motor supply line for hot air motors shielded conductor 3PH/PE L 1040mm for model 6011, 1011 ED ø 8.5mm		



1

No.	694685	Ref. No.	EA05-0202
description	motor supply line for hot air motors shielded conductor 3PH/PE L 600mm for model 1221 ED ø 8.5mm Qty 2 pcs		



1

No.	694686	Ref. No.	EA05-0203
description	motor supply line for hot air motors shielded conductor 3PH/PE L 900mm L 1.3m for model 2011 ED ø 8.5mm Qty 2 pcs		

hot air fans

HANNING



1

No.	601910	Ref. No.	EA11-0004
description	hot air fan 220-240V 125W 0.46/0.56A 3600rpm L1 115mm L2 3mm L3 12mm L4 95mm fan wheel ø 100mm HANNING		
For models:	B623i, O623i		

radial fans

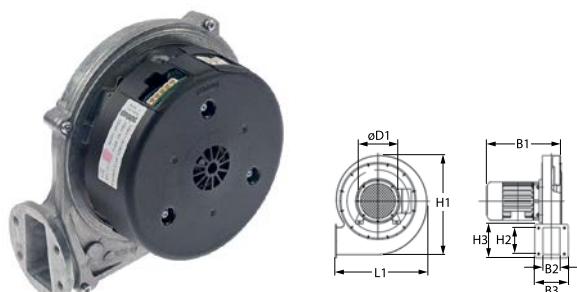

1

No.	692477	Ref. No.	ZA21-0008
description	radial fan 230V voltage AC 50Hz H1 150mm L1 170mm D1 ø 80mm W1 90mm W2 28mm H2 49mm W3 65mm H3 65mm		

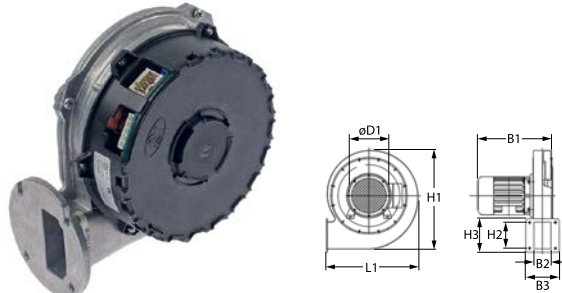

1

No.	692478	Ref. No.	ZA21-0009
description	radial fan 230V voltage AC 50Hz H1 165mm L1 170mm D1 ø 80mm W1 80mm W2 23mm H2 46mm W3 83mm H3 83mm		

motors

gear motors

for ovens

for flues



1

No.	602072	Ref. No.	AC25-0112/S AC25-0311/S
description	gear motor 5W 220-240V voltage AC 50/60Hz 3/3.6rpm shaft ømm L 84mm W 70mm H 54.4mm		



1

No.	601912	Ref. No.	EA11-0012
description	gear motor FIBER type P245J01C128 230V voltage AC 50Hz shaft ø 6.3mm L 71.5mm W 56.5mm H 46.5mm motor type M51BJ0L0000/ M51BJ0R0000		
For models:	B1011b, B1011i, B1221b, B1221i, B2011i, B2021b, B2021i, B611b, B611i, B623i		



pumps

drain pumps

HANNING



1

No.	499328	Ref. No.	EA10-0005 EA12-0005
description	pump 25W 220-240V inlet ø 30mm outlet ø 24mm 50Hz type DP020-028 HANNING		

PLASET



1

No.	499312	Ref. No.	EA12-0001
description	pump inlet ø 30mm outlet ø 22mm 220/240V 34W 50Hz PLASET type 50763		
For models:	B1011b, B1011i, B1221b, B1221i, B2011b, B2011i, B2021b, B2021i, B611b, B611i, B623i, O1011b, O1221b, O2011b, O2021b, O611b		

accessories

pump covers



1

No.	500303	Ref. No.	ZA14-0105
description	body inlet ø 24mm outlet ø 22mm suitable for drain pump		
For models:	B1221b, B1221i, B2011b, B2011i, B2021b, B2021i		

condensators & interference suppression filters

operating capacitors

metal



1

No.	365191	Ref. No.	EA13-0301
description	operating capacitor capacity 3µF 400V tolerance 5% 60Hz ambient temperature max. -40 up to +85°C ø 30mm L 85mm M8 aluminium connection cable 400mm MLR25L40303063		
For models:	B623i, O623i		

filters

line filters

with housing



1

No.	403358	Ref. No.	EA13-0057
description	line filter type FC61113 400V 50-60Hz three-phase connection cable length 500mm mounting DIN rail		
For models:	B1011b, B1011i, B611b, B611i, B623i, O1221b, O1221i, O2011b, O2011i, O2021b, O2021i, O623i		



1

No.	403357	Ref. No.	EA13-0058
description	line filter type FC61113b 400V 50-60Hz conductor 3 connection cable 500mm L 70mm ømm H 34mm W 50mm DIN rail plastic Qty 1 pcs		
For models:	B1221b, B1221i, B2011b, B2011i, B2021b, B2021i, O1011b, O1011i, O611b, O611i		



1

No.	365189	Ref. No.	EA13-0109
description	line filter type SKY2FN3 230V 50-60Hz conductor 2 with E connection spring terminal L 90mm ømm H 40mm W 52mm DIN rail plastic Qty 1 pcs		
For models:	B1011b, B1011i, B1221b, B1221i, B2011b, B2011i, B2021b, B2021i, B611b, B611i		





			
1			
No.	365190	Ref. No.	EA13-0056
description	line filter type TS8111022B 250V 50-60Hz conductor 2 with E connection cable 300mm L 41mm ømm H 38mm W 18mm DIN rail plastic Qty 1 pcs		
For models:	B1221b, B1221i, B2011b, B2011i, B2021b, B2021i, B623i, O1221b, O1221i, O2011b, O2011i, O2021b, O2021i, O623i		

fuses

line circuit breakers

miscellaneous

			
1			
No.	381233	Ref. No.	EA03-0016
description	line circuit breaker 1-pole 6A tripping type D rated 230/400V connection screw mounting DIN rail 1 phase		
For models:	B1011b, B1011i, B1221b, B1221i, B2011b, B2011i, B2021b, B2021i, B611b, B611i, B623i, O623i		

			
1			
No.	381232	Ref. No.	EA03-0018
description	line circuit breaker 3-pole 6A tripping type D rated 400V connection screw mounting DIN rail 3 phase		
For models:	O1011b, O1011i, O1221b, O1221i, O2011b, O2011i, O2021b, O2021i, O611b, O611i		

electric accessories

terminals

PCB terminal blocks

			
1			
No.	551256	Ref. No.	EA07-1310
description	PCB terminal block 10-pole max. 16A max 400V raster size 5mm		

			
1			
No.	551257	Ref. No.	EA07-1014
description	PCB terminal block 14-pole max. 1A max 240V raster size 3mm		

			
1			
No.	551255	Ref. No.	EA07-1309
description	PCB terminal block 9-pole max. 16A max 400V raster size 5mm		

electronic components

varistors



			
1			
No.	403354	Ref. No.	EA05-0200
description	varistor		

gas valves and ignition boxes

gas control valves

SIT

SIGMA

			
1			
No.	106009	Ref. No.	ZA12-0003
description	gas valve 230V 50Hz gas inlet 3/4" gas outlet 3/4" pressure range 0.5-12mbar Sigma equiv. no. 0.848.037		
spare parts for	106009		
	No.	106214	Ref. No.
			—
accessories for	106009		
	No.	107222	Ref. No.
			EA05-0055
	plug for solenoid valve 3-pole cable length 1070mm		



ignition boxes

BRAHMA

BRAHMA



1

No.	103193	Ref. No.	EA01-0203
description	ignition box BRAHMA type SM592N.2 electrodes 1 waiting time 1.5s safety time 10s 230V 7VA 50-60Hz with reset button		

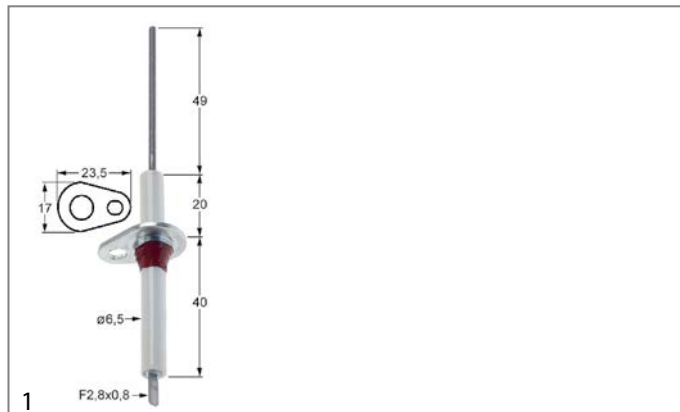

1



No.	103188	Ref. No.	AT31-0029
description	monitoring electrode flange length 23.5mm D1 ø 6.5mm flange width 17mm L1 49mm BL1 20mm BL2 40mm connection male faston 2.8mm		
accessories for	103188		
	No.	692512	Ref. No.
			AX31-0045
	gasket for flame monitoring Qty 1 RETIGO		

ignition parts

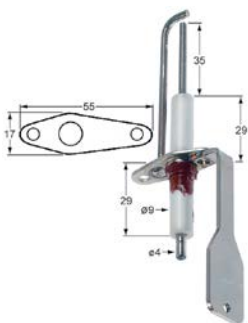
electrodes



1

No.	103191	Ref. No.	AC31-0903
description	ignition electrode flange length 55mm flange width 17mm D1 ø 9mm L1 35mm BL1 29mm BL2 29mm connection ø 4mm		
spare parts for	103191		
	No.	692511	Ref. No.
			AX31-0044
	gasket for ignition electrode Qty 1 RETIGO AC31-0903		
accessories for	103191		
	No.	692511	Ref. No.
			AX31-0044
	gasket for ignition electrode Qty 1 RETIGO AC31-0903		



1

No.	103189	Ref. No.	ZA22-0153
description	monitoring electrode flange length 23.5mm D1 ø 6.8mm flange width 17mm L1 55mm L2 19mm BL1 46mm BL2 10mm connection screw		



1

No.	103268	Ref. No.	AA31-0014
description	monitoring electrode flange length 23.5mm D1 ø 6.8mm flange width 17mm L1 64mm L2 26mm BL1 54.5mm BL2 18mm connection screw		

ignition cables

various



No.	103192	Ref. No.	EA05-0077
description	ignition cable cable length 880mm connection bullet connector 3.6 1mm ² ED ø 4.8mm insulation PTFE conductor silver plated white 0.150hm		

ignition units

BRAHMA



No.	103194	Ref. No.	EA13-0013
description	ignition unit outputs 1 220-240VAC dimensions 85x70x35mm mounting distance 60mm inlet cable outlet ø4mm type TC1SVCS 25VA 50/60Hz BRAHMA equiv. no. 15911250		

gas burners

burners for convection ovens



No.	104656	Ref. No.	ZA22-0003
description	burner 38kW W 140mm L 315mm H 120mm		

spare parts for 104656

	No.	103191	Ref. No.	AC31-0903
	description	ignition electrode flange length 55mm flange width 17mm D1 ø 9mm L1 35mm BL1 29mm BL2 29mm connection ø 4mm		

	No.	692509	Ref. No.	AP31-0100 KP31-0100
	description	frame for burner RETIGO ZA22-0003 size 320x136mm Qty 1		

	No.	692510	Ref. No.	AT31-0047 ZA13-3040
	description	gasket for burner RETIGO ZA22-0003 Qty 1m		

	No.	692511	Ref. No.	AX31-0044
	description	gasket for ignition electrode Qty 1 RETIGO AC31-0903		

accessories for	104656			
	No.	692509	Ref. No.	AP31-0100 KP31-0100
	description	frame for burner RETIGO ZA22-0003 size 320x136mm Qty 1		

	No.	692510	Ref. No.	AT31-0047 ZA13-3040
	description	gasket for burner RETIGO ZA22-0003 Qty 1m		

equipment-specific units

for ice-cube maker

hoses

formed hoses

straight

silicone hoses



No.	530062	Ref. No.	ZA11-0805
description	silicone hose ID ø 16mm ED ø 23mm L 1m t.max. 200°C transparent		

for convection ovens/combi-steamers

drain units

accessories



No.	694681	Ref. No.	AC02-2202
description	strainer insert ED ø 118mm H 13.5mm spring holder SS		
For models:	B1011b, B1011i, B1221b, B1221i, B2011b, B2011i, B2021b, B2021i, B611b, B611i, B623i, O1011b, O1011i, O1221b, O1221i, O2011b, O2011i, O2021b, O2021i, O611b, O611i, O623i		

steam pipes



No.	530920	Ref. No.	ZA10-0500
description	steam hose silicone L 68mm ID ø 38mm ED ø 46mm for combi-steamer steam generator		

injection nozzles



No.	542109	Ref. No.	AT00-0056
description	nozzle bore ø 0.7mm D1 ø 12mm brass mounting pos. inside hose 07 TYC D12-8		
For models:	B1011i, B1221i, B2011i, B2021i, B611i, B623i, O1011i, O1221i, O2011i, O2021i, O611i, O623i		



injection pipes



No.	696859	Ref. No.	AC12-0100
description	injection pipe for combi-steamer ED ø 10mm ID ø 6mm L 250mm		



No.	692480	Ref. No.	AC12-0800
description	injection pipe L 185mm H 45mm ID ø 12mm ED ø 8mm		
For models:	B623i, O623i		



No.	692483	Ref. No.	AC12-1100
description	injection pipe L 190mm H 125mm ID ø 8mm ED ø 12mm		



No.	692484	Ref. No.	AC12-0900 AC12-1300
description	injection pipe L 235mm H 130mm ID ø 8mm ED ø 12mm		
For models:	B1221b, B1221i, O1221b, O1221i		



No.	692482	Ref. No.	AC12-0700
description	injection pipe L 243mm H 115mm ID ø 8mm ED ø 12mm		
For models:	B1011b, B1011i, B2011b, B2011i, B611b, B611i, O1011b, O1011i, O2011b, O2011i, O611b, O611i		



No.	692485	Ref. No.	AC12-1000
description	injection pipe L 350mm H 130mm ID ø 8mm ED ø 12mm		
For models:	B2021b, B2021i, O2021b, O2021i		



front panels



No.	694705	Ref. No.	AC21-1406/S/CH1
description	front panel for combi-steamer L 1580mm W 190mm H 60mm SS with accessories RETIGO		
For models:	O2011b, O2011i		





1

No.	694704	Ref. No.	AC21-1506/S/CH1
description	front panel for combi-steamer L 530mm W 190mm H 60mm SS with accessories RETIGO		
For models:	O623i		
accessories for	694704		
	No.	360594	Ref. No. EA05-0052
	USB cable A mounting screw mounting bush 1.5m		
	No.	360607	Ref. No. AX21-0001+AX21-
	USB cover plastic A mounting screw mounting bush grey		





1

No.	694703	Ref. No.	AC21-1206/S/CH1
description	front panel for combi-steamer L 700mm W 190mm H 60mm SS with accessories RETIGO		
For models:	O611b, O611i		
accessories for	694703		
	No.	360594	Ref. No. EA05-0052
	USB cable A mounting screw mounting bush 1.5m		

accessories for	694703		
	No.	360607	Ref. No. AX21-0001+AX21-
USB cover plastic A mounting screw mounting bush grey			



1

No.	694702	Ref. No.	AC21-1205/S/CH1
description	front panel for combi-steamer L 700mm W 190mm H 60mm SS with accessories RETIGO for touch screen		
For models:	B611b, B611i		
accessories for	694702		
	No.	360594	Ref. No. EA05-0052
	USB cable A mounting screw mounting bush 1.5m		
	No.	360607	Ref. No. AX21-0001+AX21-
	USB cover plastic A mounting screw mounting bush grey		
	No.	404013	Ref. No. XC10-2000
	display combi-steamer Blue FreeScale2011 L 170mm W 130mm suitable for RETIGO model XC10-2000-10 with control H 50mm type blue		



No.	694770	Ref. No.	AC21-1305/S/CH1
description	front panel for combi-steamer L 960mm W 190mm H 60mm SS with accessories RETIGO for touch screen		
For models:	B1011b, B1011i		

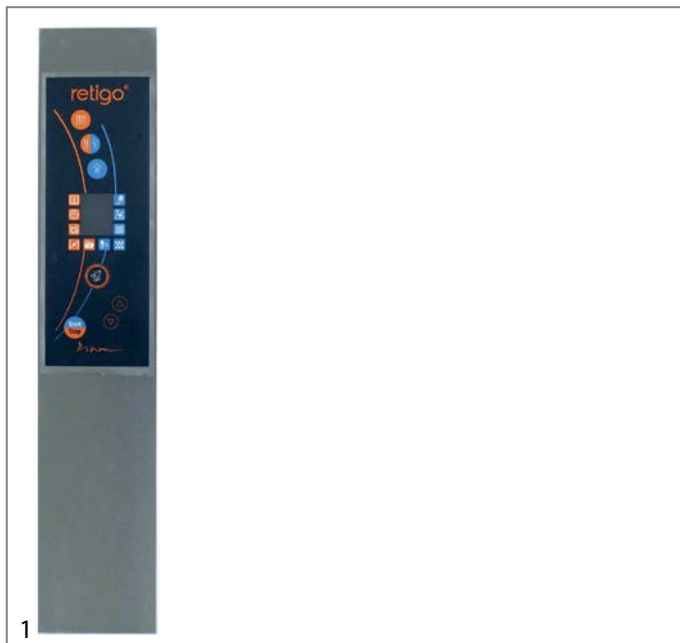

No.	694771	Ref. No.	AC21-1306/CH1
description	front panel for combi-steamer L 960mm W 190mm H 60mm SS with accessories RETIGO without touch screen		
For models:	O1011b, O1011i		

cleaning system

nozzles

			
1			
No.	694682	Ref. No.	AA32-0050 AT32-0052
description	nozzle hole ϕ 6.45mm H 17.8mm metal ED ϕ 52mm ID ϕ 44.6mm		
For models:	B1011b, B1011i, B1221b, B1221i, B2011b, B2011i, B2021b, B2021i, B611b, B611i, B623i		

hoses

			
1			
No.	698469	Ref. No.	ATOO-0006
description	hose ID ϕ 48mm ED ϕ 54mm L 83mm		

			
1			
No.	530920	Ref. No.	ZA10-0500
description	steam hose silicone L 68mm ID ϕ 38mm ED ϕ 46mm for combi-steamer steam generator		

door mechanics

accessories





			
1			
No.	694683	Ref. No.	AX03-0076
description	stop ϕ 14mm rubber ID ϕ 7.5mm H 14mm		
For models:	B1011b, B1011i, B1221b, B1221i, B2011b, B2011i, B2021b, B2021i, B611b, B611i, B623i, O1011b, O1011i, O1221b, O1221i, O2011b, O2011i, O2021b, O2021i, O611b, O611i, O623i		

			
1			
No.	694680	Ref. No.	ZA13-0516
description	stop ϕ 22.25mm rubber ID ϕ 14.75mm H 7.3mm		
For models:	B1011b, B1011i, B611b, B611i, B623i, O1011b, O1011i, O611b, O611i, O623i		

heat exchangers







1

No.	692505	Ref. No.	AC31-1700 AC31-4600	
description	heat exchanger for combi-steamer RETIGO model 1011			
accessories for	692505			
	No.	103191	Ref. No.	AC31-0903
	ignition electrode flange length 55mm flange width 17mm D1 ø 9mm L1 35mm BL1 29mm BL2 29mm connection ø 4mm			
	No.	103268	Ref. No.	AA31-0014
	monitoring electrode flange length 23.5mm D1 ø 6.8mm flange width 17mm L1 64mm L2 26mm BL1 54.5mm BL2 18mm connection screw			
	No.	692515	Ref. No.	AX31-0043
	gasket for heat exchanger Qty 1 MICA			
	No.	692516	Ref. No.	KP31-0049
	gasket for heat exchanger brass for model Qty 1			
	No.	692518	Ref. No.	AX31-0011
	gasket for gas supply Qty 1 silicone			







1

No.	692550	Ref. No.	AC31-3850	
description	heat exchanger for combi-steamer RETIGO model 2011 L 2040mm short			
accessories for	692550			
	No.	103191	Ref. No.	AC31-0903
	ignition electrode flange length 55mm flange width 17mm D1 ø 9mm L1 35mm BL1 29mm BL2 29mm connection ø 4mm			
	No.	103268	Ref. No.	AA31-0014
	monitoring electrode flange length 23.5mm D1 ø 6.8mm flange width 17mm L1 64mm L2 26mm BL1 54.5mm BL2 18mm connection screw			
	No.	692515	Ref. No.	AX31-0043
	gasket for heat exchanger Qty 1 MICA			
	No.	692516	Ref. No.	KP31-0049
	gasket for heat exchanger brass for model Qty 1			
	No.	692518	Ref. No.	AX31-0011
	gasket for gas supply Qty 1 silicone			



1

No.	692551	Ref. No.	AC31-3750	
description	heat exchanger for combi-steamer RETIGO model 2011 L 2500mm LANG			
accessories for	692551			
	No.	103191	Ref. No.	AC31-0903
	ignition electrode flange length 55mm flange width 17mm D1 ø 9mm L1 35mm BL1 29mm BL2 29mm connection ø 4mm			
	No.	103268	Ref. No.	AA31-0014
	monitoring electrode flange length 23.5mm D1 ø 6.8mm flange width 17mm L1 64mm L2 26mm BL1 54.5mm BL2 18mm connection screw			
	No.	692515	Ref. No.	AX31-0043
	gasket for heat exchanger Qty 1 MICA			
	No.	692516	Ref. No.	KP31-0049
	gasket for heat exchanger brass for model Qty 1			
	No.	692518	Ref. No.	AX31-0011
	gasket for gas supply Qty 1 silicone			



1

No.	692506	Ref. No.	AC31-1800 AC31-4700
description	heat exchanger for combi-steamer RETIGO model 611		

miscellaneous

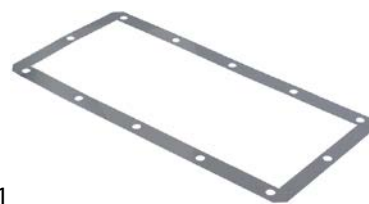



1

No.	692513	Ref. No.	KP31-0153
description	bracket PAD 1 SS mounting pos. underneath burn chamber		



1



No.	692514	Ref. No.	AP31-0152 KP31-0152	
description	bracket PAD 2 SS mounting pos. uinderneath burne chamber W 335mm H 160mm			
accessories for	692514			
	No.	692509	Ref. No.	AP31-0100 KP31-0100
	frame for burner RETIGO ZA22-0003 size 320x136mm Qty 1			
	No.	692510	Ref. No.	AT31-0047 ZA13-3040
	gasket for burner RETIGO ZA22-0003 Qty 1m			

1



No.	698467	Ref. No.	AT00-0002
description	bracket plastic for spray gun ø 21.5mm		
For models:	B1011b, B1011i, B1221b, B1221i, B2011b, B2011i, B2021b, B2021i, B611b, B611i, B623i, O1011b, O1011i, O1221b, O1221i, O2011b, O2011i, O2021b, O2021i, O611b, O611i, O623i		







1



No.	692508	Ref. No.	AC31-5000 AC31-5100
description	burner chamber RETIGO for 611 and 1011 L 400mm W 200mm H 230mm complete, but without gaskets not compatible with AC31-5000		

1



No.	692548	Ref. No.	20 AISI 316L AC31-4000	
description	burner chamber RETIGO L 480mm W 160mm H 230mm complete, but without gaskets 20 AISI 316L			
accessories for	692548			
	No.	103191	Ref. No.	AC31-0903
	ignition electrode flange length 55mm flange width 17mm D1 ø 9mm L1 35mm BL1 29mm BL2 29mm connection ø 4mm			
	No.	103268	Ref. No.	AA31-0014
	monitoring electrode flange length 23.5mm D1 ø 6.8mm flange width 17mm L1 64mm L2 26mm BL1 54.5mm BL2 18mm connection screw			
	No.	692515	Ref. No.	AX31-0043
	gasket for heat exchanger Qty 1 MICA			
	No.	692516	Ref. No.	KP31-0049
	gasket for heat exchanger brass for model Qty 1			
	No.	692518	Ref. No.	AX31-0011
	gasket for gas supply Qty 1 silicone			
	No.	692550	Ref. No.	AC31-3850
	heat exchanger for combi-steamer RETIGO model 2011 L 2040mm short			
	No.	692551	Ref. No.	AC31-3750
	heat exchanger for combi-steamer RETIGO model 2011 L 2500mm LANG			



1



No.	601914	Ref. No.	AA25-1002	
description	flap kit for combi-steamer with cable with cover cap			
spare parts for	601914			
	No.	602072	Ref. No.	AC25-0112/S AC25-0311/S
	gear motor 5W 220-240V voltage AC 50/60Hz 3/3.6rpm shaft ømm L 84mm W 70mm H 54.4mm			

spare parts for 601914			
	No.	750400	Ref. No. AC25-0105
pressure compensation valve for combi-steamer D1 ø 50mm D2 ø 84.5mm hole ø 50mm H 55mm			



No.	601913	Ref. No.	AC25-0100 V15-001-030
description	flap kit for combi-steamer with cover cap		
For models:	B1011b, B1011i, B1221b, B1221i, B2011i, B2021b, B2021i, B611b, B611i, B623i, O2011i		
spare parts for	601913		
	No.	602072	Ref. No. AC25-0112/S AC25-0311/S
gear motor 5W 220-240V voltage AC 50/60Hz 3/3.6rpm shaft ømm L 84mm W 70mm H 54.4mm			
	No.	750400	Ref. No. AC25-0105
pressure compensation valve for combi-steamer D1 ø 50mm D2 ø 84.5mm hole ø 50mm H 55mm			



No.	696592	Ref. No.	AC00-2500
description	hose connector bore ø 10mm D1 ø 10mm D2 ø 25mm SS thread M16		
For models:	B1011b, B1011i, B1221b, B1221i, B2011b, B2011i, B2021b, B2021i, B611b, B611i, B623i, O1011b, O1011i, O1221b, O1221i, O2011b, O2011i, O2021b, O2021i, O611b, O611i, O623i		



No.	750400	Ref. No.	AC25-0105
description	pressure compensation valve for combi-steamer D1 ø 50mm D2 ø 84.5mm hole ø 50mm H 55mm		
For models:	B1011b, B1011i, B1221b, B1221i, B2011i, B2021b, B2021i, B611b, B611i, B623i, O1011b, O1011i, O1221b, O1221i, O2011i, O2021b, O2021i, O611b, O611i, O623i		



No.	692479	Ref. No.	AX04-0001
description	rubber gasket rubber W 9.7mm ø 55mm for hose 379mm hole ø 38mm H 15mm		
For models:	B623i, O623i		



No.	692481	Ref. No.	AX04-0002
description	rubber gasket rubber W 9.7mm ø 65mm hole ø 48mm H 15mm		
For models:	B1011b, B1011i, B1221b, B1221i, B2011b, B2011i, B2021b, B2021i, B611b, B611i, O1011b, O1011i, O1221b, O1221i, O2011b, O2011i, O2021b, O2021i, O611b, O611i		

locks

handle latches

producer-specific

RETIGO



No.	696590	Ref. No.	AX08-0020
description	bezel for door handle suitable for combi-steamer ø 47mm black H 24mm hole ø 36mm		
For models:	B1011b, B1011i, B611b, B611i, B623i, O1011b, O1011i, O611b, O611i, O623i		





No.	692486	Ref. No.	ZA20-0901
description	catch clamp length 54mm BL 31mm for off-set 66-76mm		
For models:	B1011b, B1011i, B611b, B611i, B623i, O1011b, O1011i, O611b, O611i, O623i		



spare parts for	692486		
	No.	514450	Ref. No. AX08-0024
spring for door handle ø 6mm L 61mm W 27.5mm			

	No.	692907	Ref. No. ZA20-0910
spring holder L 20mm W 18mm H 8mm mounting pos. catch ø 4mm			



			
1			
No.	694067	Ref. No.	ZA20-0902
description	door catch with spigot 1-stage L 26mm total length 51mm thread M8		
For models:	B1011b, B1011i, B611b, B611i, B623i, O1011b, O1011i, O611b, O611i, O623i		

			
1			
No.	694066	Ref. No.	ZA20-0903
description	door catch with spigot 2-stage L 28mm W 14mm H 15mm H1 16mm total length 51mm thread M8 thread L 23mm stainless steel		
For models:	B1011b, B1011i, B611b, B611i, B623i, O1011b, O1011i, O611b, O611i, O623i		

			
1			
No.	696588	Ref. No.	AC08-0700
description	door handle L 190mm W 35mm H 60mm handle ø 60.5mm spring length 50mm screw mounting black/silver plastic flange 50mm		
For models:	B1011b, B1011i, B611b, B611i, B623i, O1011b, O1011i, O611b, O611i, O623i		
spare parts for	696588		
	No.	514450	Ref. No. AX08-0024
	 spring for door handle ø 6mm L 61mm W 27.5mm		
	No.	692486	Ref. No. ZA20-0901
	 catch clamp length 54mm BL 31mm for off-set 66-76mm		
	No.	696587	Ref. No. AX08-0021
	 door handle L 195mm W 38mm handle ø 60mm hole ø 8mm		
accessories for	696588		
	No.	694066	Ref. No. ZA20-0903
	 door catch with spigot 2-stage L 28mm W 14mm H 15mm H1 16mm total length 51mm thread M8 thread L 23mm stainless steel		
	No.	694067	Ref. No. ZA20-0902
	 door catch with spigot 1-stage L 26mm total length 51mm thread M8		
	No.	696590	Ref. No. AX08-0020
	 bezel for door handle suitable for combi-steamer ø 47mm black H 24mm hole ø 36mm		

			
1			
No.	696587	Ref. No.	AX08-0021
description	door handle L 195mm W 38mm handle ø 60mm hole ø 8mm		
For models:	B1011b, B1011i, B611b, B611i, B623i, O1011b, O1011i, O611b, O611i, O623i		

			
1			
No.	692907	Ref. No.	ZA20-0910
description	spring holder L 20mm W 18mm H 8mm mounting pos. catch ø 4mm		

hinges

door bearing

			
1			
No.	514534	Ref. No.	AAX03-0074 AP03-0135
description	bracket L 37mm W 25mm H 20mm mounting distance 15mm for glass plate		

			
1			
No.	514533	Ref. No.	AT03-0024
description	hinge bearing L 20mm W 20mm H 13mm ø 5mm without bolt for glass plate		

filters

grease filters

grease filter

			
1			
No.	970831	Ref. No.	ZA17-0010
description	grease filter W 135mm H 155mm thickness 9mm SS layers 7 outer grids 2 inner grids 5		
For models:	B1011b, B1011i, B1221b, B1221i, B2011b, B2011i, B2021b, B2021i, B611b, B611i, B623i, O1011b, O1011i, O1221b, O1221i, O2011b, O2011i, O2021b, O2021i, O611b, O611i, O623i		

equipment feet and end caps

equipment feet

with screw mounting



No.	701310	Ref. No.	AA00-0027 ZA15-0005
description	equipment foot tube ø 40mm thread M10 thread L 15mm H 80-110mm SS size 1 1/2" Qty 1 pcs		
For models:	B623i, O623i		



No.	701309	Ref. No.	AA00-0026 ZA15-0002
description	equipment foot tube ø 52mm thread M10 thread Lmm H 86-110mm SS size 2" Qty 1 pcs		
For models:	B1011b, B1011i, B611b, B611i, O1011b, O1011i, O611b, O611i		

with fixing plate



No.	701308	Ref. No.	ZA15-0008
description	equipment foot tube ø 58mm plate size 85x85mm hole distance 85mm H 208-315mm SS size 2 1/4" Qty 1 pcs		
For models:	B1221b, B1221i, B2011b, B2011i, B2021b, B2021i, O1221b, O1221i, O2011b, O2011i, O2021b, O2021i		

bolting feet



No.	701311	Ref. No.	AC09-0400
description	equipment foot ø 60.5mm H 40mm SS bore ø M10mm Qty 1 pcs		

STEINCO

with bolt hole

plastic



No.	701306	Ref. No.	ZA16-0003
description	swivel castor ø 100mm bolt hole bolt hole ø 10.3mm housing plastic capacity 90kg bearing ball bearing wheel body polypropylene tread thermoplastic H 135mm wheel width 30mm Qty 1 pcs		
For models:	B1221b, B1221i, B2011b, B2011i, B2021b, B2021i, O1221b, O1221i, O2011b, O2011i, O2021b, O2021i		



No.	701307 ¹	Ref. No.	ZA16-0004
description	swivel castor with swivel brake ø 100mm bolt hole bolt hole ø 10.3mm housing plastic capacity 90kg bearing ball bearing wheel body polypropylene tread thermoplastic H 135mm wheel width 30mm Qty 1 pcs		
For models:	B1221b, B1221i, B2011b, B2011i, B2021b, B2021i, O1221b, O1221i, O2011b, O2011i, O2021b, O2021i		

¹with swivel brake



gaskets

gaskets for heated units

door seals

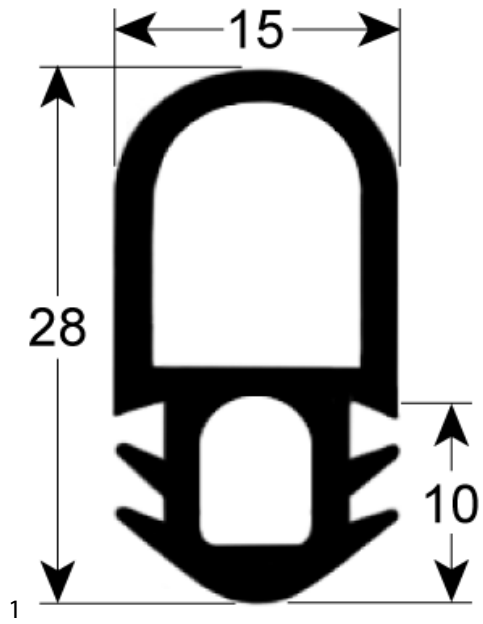

No.	901461	Ref. No.	AX00-0002
description	door seal profile 2052 W 505mm L 620mm external size		

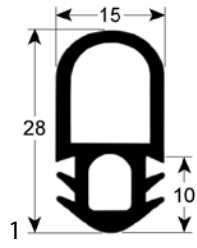

No.	901701	Ref. No.	AX00-0003
description	door seal profile 2052 W 615mm L 755mm external size		

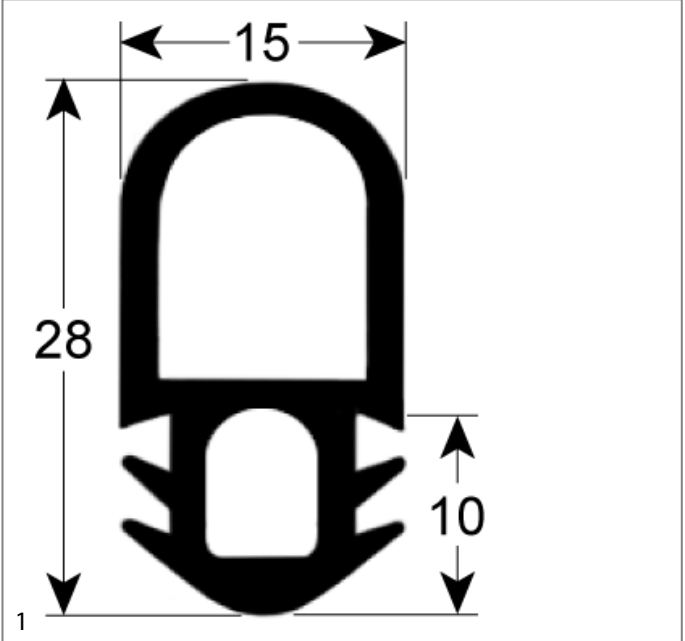

No.	902552	Ref. No.	AX00-0004
description	door seal profile 2052 W 660mm L 1420mm external size Qty 1		

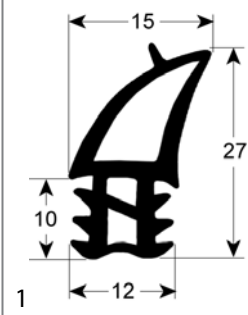

No.	901720	Ref. No.	AX00-0034
description	door seal profile 2729 W 405mm L 405mm external size Qty 1 suitable for RETIGO		
For models:	B623i, O623i		

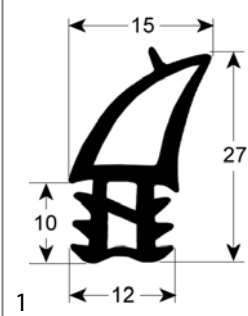

No.	901717	Ref. No.	AX00-0031 AX00-0038
description	door seal profile 2729 W 620mm L 1380mm external size Qty 1 suitable for RETIGO		
For models:	B2011b, B2011i, B2021b, B2021i, O2011b, O2011i, O2021b, O2021i		

No.	901721	Ref. No.	AX00-0035
description	door seal profile 2729 W 620mm L 490mm external size Qty 1 suitable for RETIGO		
For models:	B611b, B611i, O611b, O611i		

No.	901719	Ref. No.	AX00-0036
description	door seal profile 2729 W 620mm L 755mm external size Qty 1 suitable for RETIGO		
For models:	B1011b, B1011i, O1011b, O1011i		

No.	901718	Ref. No.	AX00-0037
description	door seal profile 2729 W 620mm L 930mm external size Qty 1 suitable for RETIGO		
For models:	B1221b, B1221i, O1221b, O1221i		

gaskets for tray rack trolleys

No.	901722	Ref. No.	AX03-0078
description	tray rack trolley gasket L 645mm W 44mm suitable for RETIGO		
For models:	B1221b, B1221i, B2011b, B2011i, B2021b, B2021i, O1221b, O1221i, O2011b, O2011i, O2021b, O2021i		

O-rings

PTFE

No.	696591	Ref. No.	ZA13-1549
description	O-ring silicone thickness 5.5mm ID ø 48.75mm		
For models:	B1011b, B1011i, B1221b, B1221i, B2011b, B2011i, B2021b, B2021i, B611b, B611i, B623i, O1011b, O1011i, O1221b, O1221i, O2011b, O2011i, O2021b, O2021i, O611b, O611i, O623i		

miscellaneous

No.	692509	Ref. No.	AP31-0100 KP31-0100
description	frame for burner RETIGO ZA22-0003 size 320x136mm Qty 1		
accessories for	692509		

No.	692510	Ref. No.	AT31-0047 ZA13-3040
description	gasket for burner RETIGO ZA22-0003 Qty 1m		

No.	692510	Ref. No.	AT31-0047 ZA13-3040
description	gasket for burner RETIGO ZA22-0003 Qty 1m		
accessories for	692510		

No.	692509	Ref. No.	AP31-0100 KP31-0100
description	frame for burner RETIGO ZA22-0003 size 320x136mm Qty 1		

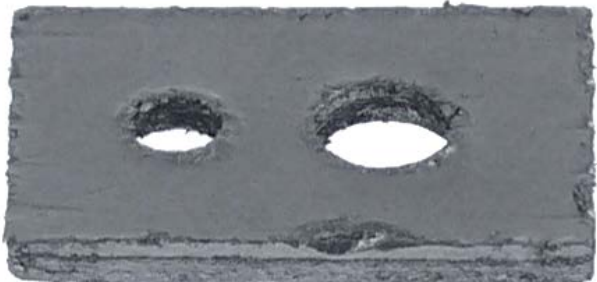
1

No.	692512	Ref. No.	AX31-0045
description	gasket for flame monitoring Qty 1 RETIGO		



1

No.	692516	Ref. No.	KP31-0049
description	gasket for heat exchanger brass for model Qty 1		

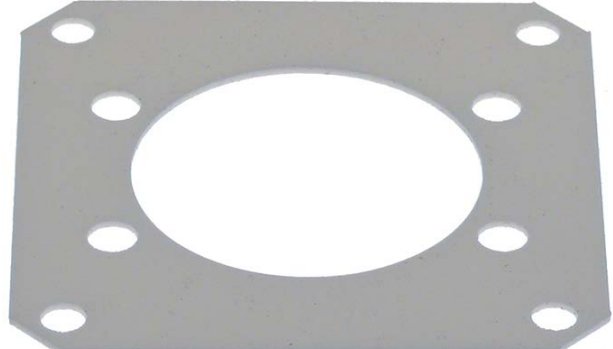

1

No.	692517	Ref. No.	AX31-0010
description	gasket for gas mixing compartment Qty 1 for type 611 and 1011		



1

No.	692515	Ref. No.	AX31-0043
description	gasket for heat exchanger Qty 1 MICA		

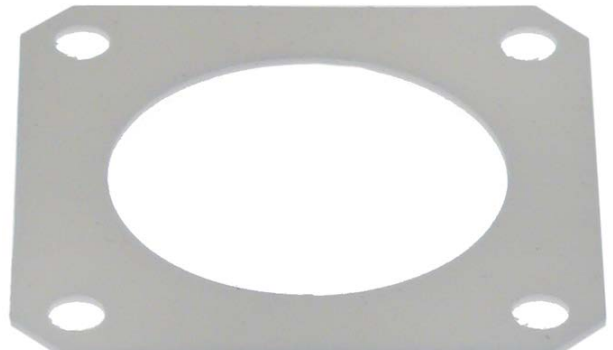

1

No.	692518	Ref. No.	AX31-0011
description	gasket for gas supply Qty 1 silicone		



1

No.	692511	Ref. No.	AX31-0044
description	gasket for ignition electrode Qty 1 RETIGO AC31-0903		

springs

miscellaneous



1

No.	514450	Ref. No.	AX08-0024
description	spring for door handle ø 6mm L 61mm W 27.5mm		



1

No.	701316	Ref. No.	AC08-0208
description	spring clip U-shape door lock shaft diametermm ømm L 40mm W 50mm Hmm wire gauge ø 0.8mm		
For models:	B1221b, B1221i, B2011b, B2011i, B2021b, B2021i, O1221b, O1221i, O2011b, O2011i, O2021b, O2021i		

tension springs



1

No.	701659	Ref. No.	AX08-0012
description	tension spring for door mechanism ø 7mm total length 44mm wire gauge ø 0.9mm for combi-steamer		

manometers



1

No.	541998	Ref. No.	ZA12-0401 ZA12-0409
description	manometer ø 40mm pressure range 0-1bar connection 1/8"		
For models:	B1011i, B1221i, B2011i, B2021i, B611i, B623i, O1011i, O1221i, O2011i, O2021i, O611i, O623i		

hose reels and spray guns

spray guns



1

No.	542038	Ref. No.	ZA15-0100
description	spray gun for appliances 3/8" IT L 135mm		
For models:	B1011b, B1011i, B1221b, B1221i, B2011b, B2011i, B2021b, B2021i, B611b, B611i, B623i, O1011b, O1011i, O1221b, O1221i, O2011b, O2011i, O2021b, O2021i, O611b, O611i, O623i		



1

No.	698468	Ref. No.	AA26-1002	
description	spray gun for appliances incl. accessories			
spare parts for	698468			
	No.	542038	Ref. No.	ZA15-0100
	spray gun for appliances 3/8" IT L 135mm			
	No.	698467	Ref. No.	AT00-0002
	bracket plastic for spray gun ø 21.5mm			



1

No.	520892	Ref. No.	ZA11-0902
description	shower hose connections 3/8" L 1600mm EPDM t.max. 110°C burst p. 10bar for combi-steamer		
For models:	B1011b, B1011i, B611b, B611i, B623i, O1011b, O1011i, O611b, O611i, O623i		



1

No.	520891	Ref. No.	ZA11-0904
description	shower hose connections 3/8" L 2100mm EPDM t.max. 110°C burst p. 10bar for combi-steamer		
For models:	B1221b, B1221i, B2011b, B2011i, B2021b, B2021i, O1221b, O1221i, O2011b, O2011i, O2021b, O2021i		



hoses

industrial hoses

PVC hoses

PVC braided hoses



1

No.	570163	Ref. No.	AA26-0101
description	PVC braided hose ID ø 10mm ED ø 17.2mm L 350m thickness 3.6mm PVC combi-steamer transparent Qty 1		



1

No.	570162	Ref. No.	AA26-0100
description	PVC braided hose ID ø 10mm ED ø 17.2mm L 440m thickness 3.6mm PVC combi-steamer transparent Qty 1		



1

No.	570164	Ref. No.	AA26-0104
description	PVC braided hose ID ø 10mm ED ø 17.2mm L 90m thickness 3.6mm PVC combi-steamer transparent Qty 1		

silicone hoses

without fabric



1

No.	530062	Ref. No.	ZA11-0805
description	silicone hose ID ø 16mm ED ø 23mm L 1m t.max. 200°C transparent		

with fabric

with monofilament braid



1

No.	530435	Ref. No.	ZA11-0803
description	silicone hose L 1m ID ø 10mm ED ø 17mm with monofilament braid thickness 3.5mm operating p. 4bar t.max. 200°C clear		
For models:	B2011i, O2011i		

formed hoses

straight



1

No.	530920	Ref. No.	ZA10-0500
description	steam hose silicone L 68mm ID ø 38mm ED ø 46mm for combi-steamer steam generator		

water cycle components

pressure reduction valves

pressure reduction valves

producer-specific



1

No.	541184	Ref. No.	ZA12-0201 ZA12-02012
description	pressure controller Metal Work series Bit MRA connection 1/4" default settingbar setting range 0-2bar p max 13bar t.max. 50°C plastic		
For models:	B1011i, B1221i, B2011i, B2021i, B611i, B623i, O1011i, O1221i, O2011i, O2021i, O611i, O623i		



1

No.	520958	Ref. No.	ZA12-0207
description	pressure reduction valve Norgren connection 1/4 / 1/8 default settingbar setting range 0.1-2bar		