

Professionall

Solutii profesionale pentru echipamente profesionale



GAS COMPONENTS



ELECTRIC COMPONENTS



WATER TECHNOLOGY



MECHANICAL COMPONENTS



TOOLS

Spare parts suitable for

ÖZTIRYAKILER



heating elements

heating elements for fryers

8 hole fixing

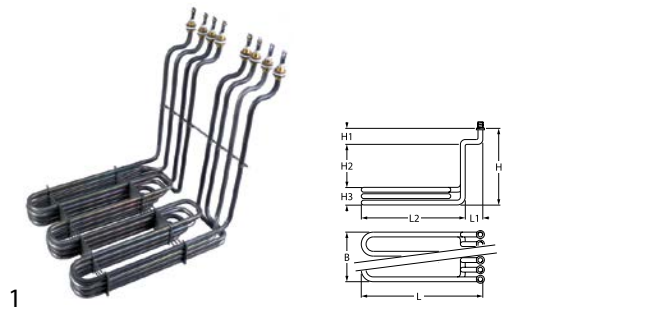

| | | | |
|--------------------|---|-----------------|---|
| No. | 418859 | Ref. No. | 6246.00045.00 6246.00045.05 6246.00047.00 |
| description | heating element 4x4500W 440V L 350mm W 255mm H 325mm 8 hole fixing connection M4 L1 50mm L2 300mm H1 40mm H2 235mm H3 45mm heating circuits 4 immersion heater tube ø 8.5mm fryer | | |

heating elements for griddles



| | | | |
|--------------------|---|-----------------|---------------|
| No. | 417624 | Ref. No. | 6246.00011.03 |
| description | heating element 1500W 230V heating circuits 1 L 430mm W 100mm H 65mm tube ø 8.5mm | | |

heating elements for contact grills

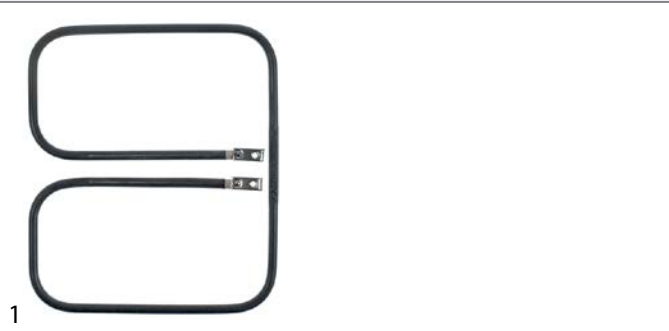

| | | | |
|--------------------|--|-----------------|---------------|
| No. | 420474 | Ref. No. | 6246.00035.00 |
| description | heating element 750W 230V heating circuits 1 L 165mm W 195mm H 30mm connection distance 20mm tube ø 6.5mm windings 1 connection M4 dry heating element for contact grill/waffle iron | | |

immersion heating elements

3 hole flange ø47.5mm

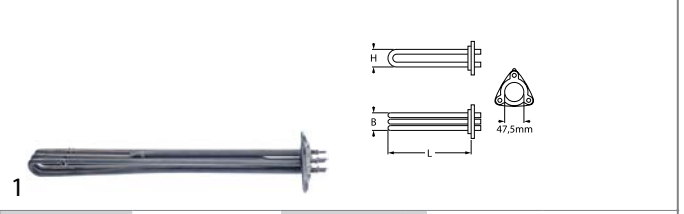

| | | | | |
|--|--|-----------------|--|--------------------------------|
| No. | 417529 | Ref. No. | 6246.00001.03 6246.00006.00 6246.00006.03 9099.01000.06 | |
| description | heating element 9000W 230V mounting ø 47.5mm heating circuits 3 L 440mm W 36mm H 31mm number of thermostat sleeves 1 thermostat sleeves ø 7mm length thermostat sleeves 255mm thermostat sleeve eccentric, clinging tube ø 8.5mm hole distance 61mm hole ø 10mm connection M4 3 hole flange immersion heater | | | |
| For models: | OBK1500 | | | |
| accessories for | 417529 | | | |
| | No. | 510408 | Ref. No. | 6228.00001.22 6228.00001.26 |
| O-ring EPDM thickness 5.34mm ID ø 47mm Qty 1 pcs | | | | |

with expansion flange 70 x 18mm



| | | | |
|--------------------|---|-----------------|---------------|
| No. | 420366 | Ref. No. | 9099.01000.03 |
| description | heating element 2000/2500W 230V heating circuits 2 flange 70x18mm L 418mm W 64mm connection M4 tube ø 8.5mm immersion heater expansion flange | | |



| | | | |
|--------------------|---|-----------------|--------------------------------|
| No. | 417717 | Ref. No. | 6246.00012.12 9099.01000.01 |
| description | heating element 2950W 230V heating circuits 1 flange 70x18mm L 285mm W 70mm connection male faston 6.3mm tube ø 8.5mm immersion heater expansion flange | | |

heating elements for convection



| | | | |
|--------------------|--|-----------------|---------------|
| No. | 417622 | Ref. No. | 6246.00020.00 |
| description | heating element 1500W 220V heating circuits 1 ID ø 198mm ED ø 210mm L 225mm H 35mm L1 8mm W1 30mm H1 13mm H2 20mm flange length 70mm flange width 22mm hole distance 56mm connection M4 tube ø 6.5mm convection heating element rectangular flange | | |



| | | | |
|---|--|-----------------|---|
|  | | | |
| 1 | | | |
| No. | 420544 | Ref. No. | 6246.00049.05 7AYS.00008.17 7AYS.00008.18 |
| description | heating element 1500W 230V heating circuits 1 ID ø 195mm ED ø 208mm L 210mm H 30mm W1 30mm H1 10mm H2 18mm flange length 70mm flange width 22mm hole distance 56mm connection F6.3 connection length 20mm tube ø 6.5mm | | |

radiation heaters

| | | | |
|---|--|-----------------|---|
|  | | | |
| 1 | | | |
| No. | 417647 | Ref. No. | 2859.M0012.00 6802.00001.110 6802.00001.114 |
| description | radiation heater rectangular L 230mm W 158mm H 50mm heating circuits 1 | | |

foil heating elements

| | | | |
|---|--|-----------------|----------------------------|
|  | | | |
| 1 | | | |
| No. | 416371 | Ref. No. | 62460000806 7AYS0000902 |
| description | foil heating element L 400mm W 290mm 1000W 230V t.max. 140°C with temperature limiter silicone cable length 2000mm thickness 1mm | | |

accessories

sealing washers

O-rings

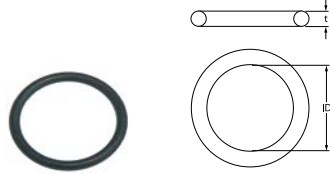
| | | | |
|--|--|-----------------|--------------------------------|
|  | | | |
| 1 | | | |
| No. | 510408 | Ref. No. | 6228.00001.22 6228.00001.26 |
| description | O-ring EPDM thickness 5.34mm ID ø 47mm Qty 1 pcs | | |

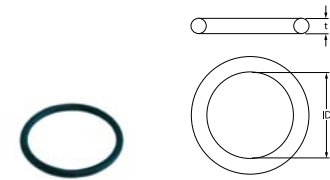
| | | | |
|--|---|-----------------|---------------|
|  | | | |
| 1 | | | |
| No. | 510409 | Ref. No. | 6228.00002.14 |
| description | O-ring EPDM thickness 5.34mm ID ø 56.52mm Qty 1 pcs | | |

hot plates

round

with radiused edge

for domestic and commercial kitchens

| | | | |
|--|--|-----------------|---------------|
|  | | | |
| 1 | | | |
| No. | 490021 | Ref. No. | 6246.00013.02 |
| description | hot plate ø 220mm 2600W 400V connection 4 screw clamps with 8mm spill ring | | |

energy regulators

EGO

1-circuit

| | | | |
|--|---|-----------------|---------------|
|  | | | |
| 1 | | | |
| No. | 380019 | Ref. No. | 6234.00001.11 |
| description | energy regulator 240V 13A single-circuit turn direction right shaft ø 6x4.6mm shaft L 23mm mounting thread M4 power release 6-100% no. 50.57071.010 | | |

thermostats

control and safety thermostats

EGO

control thermostats

55.34_ series



| | | | |
|--------------------|---|-----------------|---------------|
| No. | 390979 | Ref. No. | 6234.00001.37 |
| description | thermostat t.max. 129°C temperature range 34-129°C 3-pole 3NO 16A probe ø 6mm probe L 140mm capillary pipe 2260mm capillary pipe isolated 120mm gland nut shaft ø 6x4.6mm shaft L 23mm shaft position upper rotation 270° outer switch probe material SS probe thread screw connection disc ømm | | |



| | | | |
|---|--|-----------------|-------------------|
| No. | 375038 | Ref. No. | 6234.00001.14 |
| description | thermostat t.max. 300°C temperature range 50-300°C 3-pole 3NO 16A probe ø 6mm probe L 79mm capillary pipe 1740mm capillary pipe isolated 800mm gland nut shaft ø 6x4.6mm shaft L 23mm shaft position upper rotation 270° | | |
| accessories for | 375038 | | |
|  | No. | 110123 | Ref. No. — |
| | knob thermostat t.max. 300°C ø 50mm shaft ø 6x4.6mm shaft flat upper black temperature range 50-300°C rotation 270° | | |

safety thermostats

55.32_ series

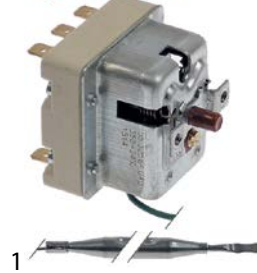

| | | | |
|--------------------|---|-----------------|---------------|
| No. | 390141 | Ref. No. | 6234.00001.28 |
| description | safety thermostat switch-off temp. 350°C 3-pole 3NC 20A probe ø 6mm probe L 77mm capillary pipe 1490mm capillary pipe isolated 800mm gland nut probe SS | | |

56_ series



| | | | |
|--------------------|--|-----------------|--------------------------------|
| No. | 390714 | Ref. No. | 6234.00001.16 6234.00001.27 |
| description | safety thermostat switch-off temp. 230°C 1-pole 1NC 16A probe ø 6mm probe L 75mm capillary pipe 740mm capillary pipe isolated 200mm gland nut probe SS | | |



| | | | |
|--------------------|---|-----------------|---------------|
| No. | 375973 | Ref. No. | 6234.00001.26 |
| description | safety thermostat switch-off temp. 365°C 1-pole 20A probe ø 3.1mm probe L 160mm capillary pipe 910mm capillary pipe isolatedmm gland nut probe SS | | |

TECASA

control thermostats

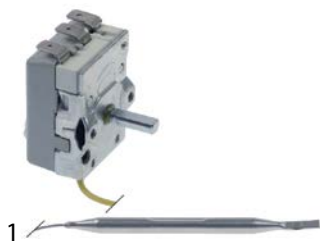

| | | | |
|--------------------|--|-----------------|----------------|
| No. | 390927 | Ref. No. | 6234.00001.080 |
| description | thermostat t.max. 110°C temperature range 30-110°C 1-pole 1CO 16A probe ø 6mm probe L 91mm capillary pipe 880mm capillary pipe isolated 850mm gland nut shaft ø 6x4.6mm shaft L 18mm shaft position upper rotation 270° 400V | | |
| For models: | OBK1500 | | |



| | | | |
|--------------------|---|-----------------|--------------------------------|
| No. | 375472 | Ref. No. | 6234.00001.17 6234.00001.40 |
| description | thermostat t.max. 190°C temperature range 60-180°C 1-pole 1NO 16A probe ø 6mm probe L 70mm capillary pipe 2000mm capillary pipe isolated 490mm gland nut shaft ø 6x4.6mm shaft L 23mm shaft position lower° rotation 270° probe material SS | | |

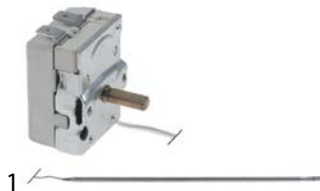

| | | | |
|--------------------|--|-----------------|---------------|
| No. | 375909 | Ref. No. | 6234.00001.05 |
| description | thermostat t.max. 300°C temperature range 50-300°C 1-pole 1NO 16A probe ø 3mm probe L 165mm capillary pipe 870mm capillary pipe isolatedmm gland nut shaft ø 6x4.6mm shaft L 23mm shaft position upper rotation 270° | | |

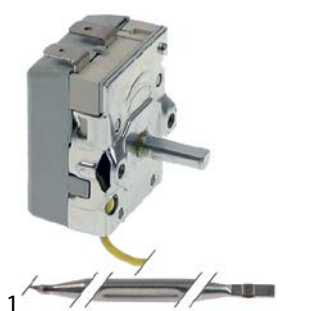

| | | | |
|--------------------|---|-----------------|--------------------------------|
| No. | 390980 | Ref. No. | 6234.00001.18 6234.00001.42 |
| description | thermostat t.max. 90°C temperature range 30-90°C 1-pole 1NO 16A probe ø 6mm probe L 95mm capillary pipe 1550mm capillary pipe isolated 1500mm gland nut shaft ø 6x4.6mm shaft L 16mm shaft position° shaft position upper rotation 270° outer switch probe material SS probe thread disc ømm screw connection | | |

safety thermostats

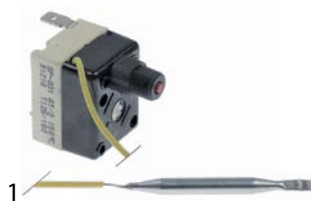

| | | | |
|--------------------|---|-----------------|--------------------------------|
| No. | 390796 | Ref. No. | 6234.00001.04 6234.00001.21 |
| description | safety thermostat switch-off temp. 150°C 1-pole 1NC 16A probe ø 6mm probe L 65mm capillary pipe 1480mm capillary pipe isolated 1450mm | | |
| For models: | OBK1500 | | |



| | | | |
|--------------------|---|-----------------|---------------|
| No. | 376000 | Ref. No. | 6234.00001.41 |
| description | safety thermostat switch-off temp. 230°C 1-pole 1NO 16A probe ø 6mm probe L 58mm capillary pipe 2000mm capillary pipe isolated 490mm gland nut probe SS | | |

various

control thermostats



| | | | |
|--------------------|--|-----------------|--------------------------------|
| No. | 390744 | Ref. No. | 6234.00001.34 6234.00001.40 |
| description | thermostat t.max. 190°C temperature range 60-190°C 1-pole 1NO probe ø 6mm probe L 69mm capillary pipe 2040mm shaft ø 6x4.6mm shaft L 26mm shaft position upper rotation 270° probe material SS | | |

refrigeration thermostats

RANCO

K50 series



| | | | |
|--------------------|---|-----------------|------------------------------|
| No. | 390546 | Ref. No. | 6268.00013.01 7AYS0000228 |
| description | thermostat RANCO type K50P1127 probe ømm probe Lmm capillary pipe 1200mm temperature range +1.5 up to +12.5°C | | |



switches and momentary switches

rocker/momentary rocker switches

30x22mm



1

| | | | |
|---|---|-----------------|-----------------|
| No. | 301003 | Ref. No. | 62320001900 |
| description | rocker switch mounting measurements 30x22mm green 2NO 250V 16A illuminated 0-1 connection male faston 6.3mm ambient temperature max. 125/55°C protection IP65 | | |
| accessories for | 301003 | | |
|  | No. | 301036 | Ref. No. |
| | | | — |
| description | protective cover internal size 30x22mm for rocker switch mounting measurementsmm | | |



1

| | | | |
|--------------------|--|-----------------|------------------------------|
| No. | 301251 | Ref. No. | 6232.00001.21 7AYS0000136 |
| description | rocker switch mounting measurements 30x22mm green 2NO 250V 16A illuminated lighting connection male faston 6.3mm ambient temperature max. 85°C protection IP40 | | |

ø20mm



1

| | | | |
|--------------------|--|-----------------|--------------------------------|
| No. | 348204 | Ref. No. | 6232.00011.01 6232.00011.27 |
| description | rocker switch mounting measurements 20mm green 1CO 250V 4A 0-1 | | |



1

| | | | |
|--------------------|---|-----------------|--------------------------------|
| No. | 348203 | Ref. No. | 6232.00011.00 6232.00011.28 |
| description | rocker switch mounting measurements 20mm orange 1CO 250V 4A 0-1 | | |

toggle switches

M12x1



1

| | | | |
|--------------------|--|-----------------|---------------|
| No. | 347340 | Ref. No. | 6232.00020.01 |
| description | toggle switch thread M12x1 1NO 250V 15A ON-OFF screw | | |

position switches

PIZZATO

FR series



1

| | | | |
|--------------------|---|-----------------|---------------|
| No. | 345181 | Ref. No. | 6232.00010.33 |
| description | position switch plastic 1NC/1NO 400V 3A L 92mm W 31mm H 31mm protection IP67 actuating force: 450g screw connection PG13.5 mounting distance 22mm screw | | |

miscellaneous



1



| | | | |
|--------------------|---|-----------------|---------------|
| No. | 347962 | Ref. No. | 6232.00006.00 |
| description | position switch 1NO/1NC L 68mm W 30mm H 24mm | | |
| For models: | OM10G, OM20G, OM40G, OM60G, PSM10, PSM20, PSM30 | | |

cam switches

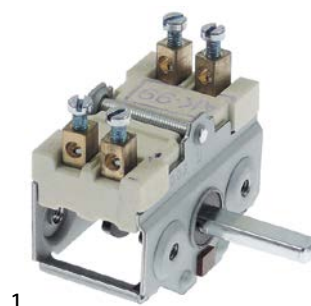
on/off



1

| | | | |
|---|---|-----------------|-----------------|
| No. | 300020 | Ref. No. | 6254.00005.03 |
| description | cam switch 4 operating positions 2NO sequence 0-1-0-1 16A shaft ø 6x4.6mm shaft L 23mm connection screw ceramic | | |
| accessories for | 300020 | | |
|  | No. | 110135 | Ref. No. |
| | | | — |
| description | rosette knob up to ø 52mm | | |
|  | No. | 110231 | Ref. No. |
| | | | — |
| description | knob switch 0-1-0-1 t.max.°C ø 50mm shaft ø 6x4.6mm shaft flat upper black | | |



7-position



| | | | |
|--------------------|---|-----------------|---------------|
| No. | 300106 | Ref. No. | 6254.00005.00 |
| description | cam switch 7 operating positions 1NO/2CO sequence 0-1-2-3-4-5-6 32A shaft ø 6x4.6mm shaft L 23mm connection screw 7-position shaft flat upper | | |

operation switches



| | | | |
|--------------------|---|-----------------|---------------|
| No. | 300002 | Ref. No. | 6254.00005.04 |
| description | cam switch 2 operating positions 4NO 16A sequence 0-1 shaft ø 6x4.6mm shaft L 23mm connection male faston 6.3mm ceramic | | |

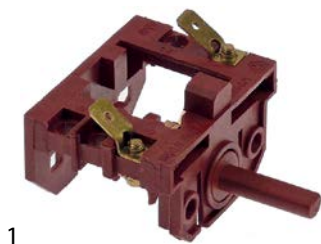

| | | | |
|--------------------|---|-----------------|---------------|
| No. | 300257 | Ref. No. | 6232.00024.10 |
| description | operation switch 16A sequence 0-1 shaft ø 6x4.6mm shaft L 22mm connection male faston 6.3mm | | |

magnetic switches

miscellaneous



| | | | |
|------------------------|--|-----------------|-----------------|
| No. | 347961 | Ref. No. | 6232.00005.10 |
| description | magnetic switch 250V 3A P max. 750W 1NO connection cable L 12mm cable length 1000mm L1 37mm mounting measurements 58x13mm H 9mm mounting distance 49.5mm voltage AC nominal 5A | | |
| For models: | OBK1500 | | |
| accessories for | 347961 | | |
| | No. | 699294 | Ref. No. |
| | magnet ø 20.8mm H 12.5mm ID ø 5mm with screw | | |

accessories

magnets



| | | | |
|--------------------|--|-----------------|---|
| No. | 699294 | Ref. No. | 621300002.03+626200004.01 6232.00004.17 siehe bemerkung |
| description | magnet ø 20.8mm H 12.5mm ID ø 5mm with screw | | |
| For models: | OBK1500 | | |

control equipment

MOELLER/EATON

push buttons - signal lamps



| | | | |
|--------------------|---|-----------------|---------------|
| No. | 346272 | Ref. No. | 6232.00012.08 |
| description | push button mounting measurements ø22mm green | | |

switch blocks



| | | | |
|--------------------|-------------------------|-----------------|---------------|
| No. | 346292 | Ref. No. | 6232.00012.05 |
| description | contact block screw 1NO | | |



| | | | |
|--------------------|-----------------------------|-----------------|---------------|
| No. | 346293 | Ref. No. | 6232.00012.07 |
| description | contact block holder triple | | |

LED signal elements



| | | | |
|--------------------|--|-----------------|---------------|
| No. | 348202 | Ref. No. | 6232.00012.04 |
| description | indicator lamp yellow connection screw LED 85-264VAC | | |



miscellaneous

| | | | |
|---|---|-----------------|---------------|
|  | | | |
| 1 | | | |
| No. | 347964 | Ref. No. | 6232.00003.02 |
| description | momentary push switch mounting measurements ø22mm green 1NO 10A 1-pole SMCX | | |
| For models: | OM10G, OM20G, OM40G, OM60G, PSM10, PSM20, PSM30 | | |

| | | | |
|---|---|-----------------|--------------------------------|
|  | | | |
| 1 | | | |
| No. | 347963 | Ref. No. | 6232.00003.05 6232.00003.06 |
| description | momentary push switch mounting measurements ø22mm red 1NC 10A 1-pole SMCX | | |
| For models: | OM10G, OM20G, OM40G, OM60G, PSM10, PSM20, PSM30 | | |

encoders and potentiometers

| | | | |
|--|--|-----------------|---------------|
|  | | | |
| 1 | | | |
| No. | 403313 | Ref. No. | 6229.00034.09 |
| description | potentiometer 2.5KOhm cable length 130mm L 44mm ø 22.5mm | | |
| For models: | OM10G | | |

lamps

indicator lights

indicator lights (complete)

ø10mm

with screw socket

| | | | |
|---|--|-----------------|---------------|
|  | | | |
| 1 | | | |
| No. | 360649 | Ref. No. | 6251.00004.10 |
| description | indicator light ø 10mm green 240V cable length 300mm | | |

| | | | |
|---|---|-----------------|---------------|
|  | | | |
| 1 | | | |
| No. | 360652 | Ref. No. | 6251.00004.07 |
| description | indicator light ø 10mm red 240V connection cable 300mm cable length 300mm | | |

| | | | |
|---|---|-----------------|------------------------------|
| 30x22mm | | | |
|  | | | |
| 1 | | | |
| No. | 359302 | Ref. No. | 6232.00001.22 7AYS0000226 |
| description | indicator light mounting measurements 30x22mm yellow 240V temp.-resist. 120°C | | |

fluorescent lamps

fluorescent lamps



complete with holder

| | | | |
|--|------------------------------------|-----------------|------------------------------|
|  | | | |
| 1 | | | |
| No. | 359481 | Ref. No. | 6250.00001.35 7AYS0000232 |
| description | fluorescent lamp L 1204mm 28W 230V | | |

oven lamps

universal oven lamps

mounting diameter 35.5mm

| | | | | |
|---|--|-----------------|-----------------|---|
|  | | | | |
| 1 | | | | |
| No. | 359718 | Ref. No. | 62600016006 | |
| description | oven lamp mounting ø 35.5mm 230V 15W socket E14 temp.-resist. 300°C connection male faston 6.3mm hard glas | | | |
| spare parts for | 359718 | | | |
| | No. | 359701 | Ref. No. | — |
| |  lamp socket socket E14 220-230V mounting ø 35.5mm connection male faston 6.3mm 15W | | | |
| | No. | 359740 | Ref. No. | — |
| |  light bulb t.max. 300°C socket E14 15W 230V ø 22mm L 48mm lens L 20mm for oven lamp IMPORT | | | |

timers

mechanical timers

| | | | |
|--|--|-----------------|---------------|
|  | | | |
| 1 | | | |
| No. | 350204 ¹ | Ref. No. | 6259.00002.00 |
| description | timer 600 2-pole operation time 4min impulse mechanical 2NO at 250V 16A permanent position no shaft ø 6x4.6mm shaft 6x4.6mm shaft L 21mm mounting distance 28mm connection male faston 6.3mm | | |
| For models: | PSM10, PSM20, PSM30 | | |

¹incl. knob and symbol

| | | | |
|---|---|-----------------|---------------|
|  | | | |
| 1 | | | |
| No. | 350205 | Ref. No. | 6259.00002.05 |
| description | timer M11 with bell 1-pole operation time 90min impulse mechanical 1NO at 250V 16A permanent position yes shaft \varnothing 6x4.6mm shaft 6x4.6mm shaft L 25mm mounting distance 28mm mounting thread M4 connection male faston 6.3mm | | |
| For models: | OM20G, OM40G, OM60G | | |

MOELLER/EATON

power contactors

| | | | |
|--|--|-----------------|---------------|
|  | | | |
| 1 | | | |
| No. | 380171 | Ref. No. | 6230.00014.12 |
| description | power contactor resistive load 20A 230VAC (AC3/400V) 9A/4kW main contacts 3NO auxiliary contacts 1NO connection screw connection type DILEM 10 | | |

contactors

LS Industrial Systems

power contactors



| | | | |
|--|--|-----------------|---------------|
|  | | | |
| 1 | | | |
| No. | 380877 | Ref. No. | 6230.00014.06 |
| description | power contactor resistive load 60A 230VAC (AC3/400V) 40A/18.5kW main contacts 3NO auxiliary contacts 2NO/2NC connection screw connection type GMC-40 | | |

relays

power relays

with male contacts



bullet connectors, 11 contacts

| | | | |
|---|---|-----------------|-----------------|
|  | | | |
| 1 | | | |
| No. | 380132 | Ref. No. | 6231.00023.12 |
| description | power relays Italiana Relè 230VAC 10A 3CO connection plug-in connection round 11-pole manif. no. C43-230AC ZVE11 250V 11-pole | | |
| For models: | OBK1500 | | |
| accessories for | 380132 | | |
| | No. | 380136 | Ref. No. |
| | | | — |
| |  relay socket 11-pole connection plug-in connection round 11-pole dimensions 65x28x40mm 250V voltage AC 10A Italiana Relè manif. no. ZVE11 | | |

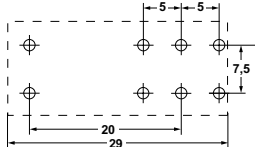

overload switches

| | | | |
|---|--|-----------------|---------------|
|  | | | |
| 1 | | | |
| No. | 381200 | Ref. No. | 6231.00001.00 |
| description | motor protection circuit breaker setting range 1.6-2.5A type GTK-12M LS Industrial Systems | | |
| For models: | PSM10 | | |

plug-in/print relays

| | | | |
|--|--|-----------------|---|
|  | | | |
| 1 | | | |
| | | |  |
| No. | 380333 | Ref. No. | 6231.00020.02 6231.00023.15 6231.00025.07 |
| description | print relay 230VAC 2CO at 250V 8A connection pins raster size 5mm FINDER manif. no. 40.52.8.230.0000 95.65/95.75 | | |
| For models: | OBK1500 | | |
| accessories for | 380333 | | |
| | No. | 380340 | Ref. No. |
| | | | — |
| |  relay socket dimensions 62x36x15mm 250V voltage AC 10A Italiana Relè manif. no. ZMEM/5 | | |



| accessories for | | 380333 | |
|---|---|----------|---|
| No. | 380505 | Ref. No. | — |
|  | relay socket 2CO 40.52 dimensions 81.9x15.5x75mm 250V voltage AC 10A FINDER manuf. no. 95.95.3 | | |
| No. | 381181 | Ref. No. | — |
|  | relay socket 2-pole 40.51/40.52/40.61 connection screw clamp dimensions 15.8x78.6mm 250V voltage AC 10A FINDER manuf. no. 95.75 | | |

time relays

time relays

|  | | | |
|---|--|----------|---------------|
| 1 | | | |
| No. | 381201 | Ref. No. | 6231.00019.07 |
| description | time relay INTER RR-W03D time range 0.1-3min 12/24VAC/DC-230VAC 5A connection screw clamp mounting measurements DIN railmm | | |
| For models: | OBK1500 | | |



|  | | | |
|--|---|----------|--|
| 1 | | | |
| No. | 381541 | Ref. No. | 6231.00019.05 6231.00019.22 RR-5T RR-W5TB |
| description | time relay INTER RR-W5TB connection grip connection | | |







electronic controllers

DIXELL

refrigeration controllers

built-in version

|  | | | | |
|---|---|----------|------------------------------|---|
| 1 | | | | |
| No. | 378256 | Ref. No. | 6234.00009.18 7AYS0000700 | |
| description | electronic controller DIXELL XR02CX-5N0C0 mounting measurements 71x29mm built-in depth 56mm 230V voltage AC NTC relay outputs 1 CO-8A(4) NTC protection IP54 defrosting function/time control -40 up to +110°C display 2½ digit | | | |
| spare parts for | 378256 | | | |
| | No. | 379161 | Ref. No. | — |
|  | temperature probe NTC 10kOhm cable thermoplastic probe -40 up to +110°C cable -40 up to +110°C probe ø6x14mm cable length 3m without screw connection 2-wire | | | |

| accessories for | | 378256 | |
|---|--|----------|---------------|
| No. | 378194 | Ref. No. | — |
|  | temperature probe NTC 10kOhm cable PVC probe -20 up to +80°C cable -10 up to 100°C probe ø7x24.5mm cable length 1.5m without screw connection 2-wire | | |
| No. | 379057 | Ref. No. | — |
|  | temperature probe NTC 10kOhm cable PVC probe -20 up to +80°C cable -10 up to 100°C probe ø6x25mm cable length 3m 2-wire | | |
| No. | 379160 | Ref. No. | 6234.00004.06 |
|  | temperature probe NTC 10kOhm cable thermoplastic probe -40 up to +110°C cable -40 up to +110°C probe ø6x14mm cable length 1.5m without screw connection 2-wire | | |
| No. | 379161 | Ref. No. | — |
|  | temperature probe NTC 10kOhm cable thermoplastic probe -40 up to +110°C cable -40 up to +110°C probe ø6x14mm cable length 3m without screw connection 2-wire | | |
| No. | 379343 | Ref. No. | — |
|  | temperature probe NTC 10kOhm cable silicone probe -40 up to +110°C cable -50 up to +180°C probe ø6x40mm cable length 3m 2-wire | | |
| No. | 379458 | Ref. No. | — |
|  | temperature probe NTC 10kOhm cable silicone probe -40 up to +110°C cable -50 up to +180°C probe ø6x40mm cable length 1.5m without screw connection 2-wire | | |

electronic thermometers

built-in version

|  | | | |
|---|---|----------|------------------------------|
| 1 | | | |
| No. | 378257 | Ref. No. | 6234.00009.19 7AYS0000703 |
| description | thermometer DIXELL XT11S-500 mounting measurements 58x25.5mm 230V voltage AC NTC -40 up to +110°C display 3 digits 1 Templn1 NTC DigiIn1 defr. funct. | | |



EVCO - EVERY CONTROL

refrigeration controllers

built-in version

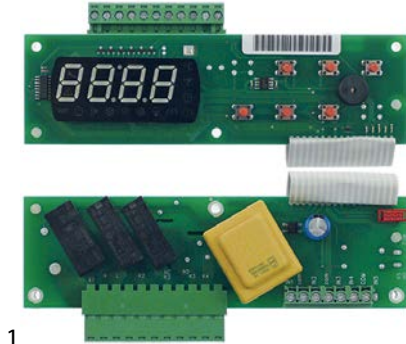

| | | | |
|--------------------|---|-----------------|---------------|
| No. | 381444 | Ref. No. | 6234.00009.27 |
| description | electronic controller EVCO type EVX003N7XXBXX02 mounting measurements 155x45mm 230V voltage AC NTC relay outputs 4 NO-16A(5) NO-16A NO-16A NTC(PTC) NTC(PTC) for fridge front measurementsmm built-in depth 56mm protection IP00 yes -40 up to +99°C display 4 digits | | |

probes

universal probes

temperature probes



| | | | |
|--------------------|--|-----------------|---------------|
| No. | 379160 | Ref. No. | 6234.00004.06 |
| description | temperature probe NTC 10kOhm cable thermoplastic probe -40 up to +110°C cable -40 up to +110°C probe ø6x14mm cable length 1.5m without screw connection 2-wire | | |
| For models: | 7919.06LMV.00, 7919.06NMV.00, 7919.12LMV.00, 7919.12NMV.00, 7919.27LMV.00, 7919.27NMV.00, 7919.37LMV.00, 7919.37NMV.00 | | |

producer-specific probes

probes



| | | | |
|--------------------|--|-----------------|---------------|
| No. | 378515 | Ref. No. | 6234.00005.03 |
| description | temperature probe thermocouple J (Fe-CuNi) cable Vetrotex probe -50 up to +750°C cable -50 up to +350°C connection 2-wire thread M6 probe ø4x65mm cable length 0.97m | | |

electronics

PCBs



| | | | |
|--------------------|---|-----------------|---------------|
| No. | 404025 | Ref. No. | 6234.00009.50 |
| description | control PCB freezer V13.06 L 156mm edition WC3LDL0TC1701 H 44mm buttons 6 ELIWELL | | |
| For models: | 7919.06LMV.00, 7919.06NMV.00, 7919.27LMV.00, 7919.27NMV.00, 7919.37NMV.00 | | |

keypads

front foils



| | | | |
|--------------------|--|-----------------|---------------|
| No. | 531271 | Ref. No. | 6800.00001.24 |
| description | keypad foil refrigerator 791912MV/791927 L 170mm W 65mm buttons 6 | | |
| For models: | 7919.12LMV.00, 7919.12NMV.00, 7919.27LMV.00, 7919.27NMV.00, 7919.37LMV.00, 7919.37NMV.00 | | |

solenoid valves

solenoid valves (water)

ELTEK



| | | | |
|--------------------|--|-----------------|---------------|
| No. | 370750 | Ref. No. | 6262.00008.00 |
| description | solenoid valve single straight 230VAC inlet 3/4" outlet 11.5mm DN10 t.max. 90°C ELTEK plastic flow regulating valve inlet blue | | |
| For models: | OBK1500 | | |



pressure switches

for warewashing

ø 58mm with coded plug



1

| | | | |
|--------------------|---|-----------------|---------------|
| No. | 542365 | Ref. No. | 6262.00007.00 |
| description | pressure control pressure range 85/65mbar connection 6mm ø 58mm | | |

fans

refrigeration fans

refrigeration motors universal

ELCO

N series - standard



1

| | | | |
|---|---|-----------------|-------------------|
| No. | 601930 | Ref. No. | 6268.00008.06 |
| description | fan motor ELCO 10W 230V 50/60Hz bearing slide bearing L1 55.5mm L2 91.5mm L3 119mm W 83mm cable length 2000mm 1300/1550rpm 5 mounting options VN10-20/929 | | |
| For models: | 7919.06LMV.00, 7919.12LMV.00, 7919.12NMV.00, 7919.27LMV.00, 7919.27NMV.00, 7919.37LMV.00, 7919.37NMV.00 | | |
| spare parts for | 601930 | | |
|  | No. | 601284 | Ref. No. — |
| | fan wheel sucking ø 254mm fan wheel mounting 25.4mm blade angle 28° W 42mm aluminium | | |

miscellaneous



1

| | | | |
|--------------------|--|-----------------|---------------|
| No. | 602005 | Ref. No. | 6268.00008.05 |
| description | fan motor 5W 230V 50/60Hz bearing slide bearing L1 40mm L2 59.6mm L3 74.2mm W 83mm connection cable 500mm cable length 500mm 1300/1550rpm 3 mounting options | | |
| For models: | 7919.06NMV.00 | | |

hot air motors



1

| | | | |
|---|--|-----------------|-------------------|
| No. | 601503 | Ref. No. | 5FIR.35011.12 |
| description | fan wheel D1 ø 350mm H1 125mm blades 12 D2 ø 13mm D3 ø 16mm | | |
| accessories for | 601503 | | |
|  | No. | 500505 | Ref. No. — |
| | fan motor 220-240/380-415V 3 phase 50/60Hz 0.16-0.26kW 1440/1700rpm speeds 2 L1 140mm L2 27mm L3 35mm M10R IT 1.2/0.7A Cos(fi) 0.63 type L7zAw4D-014 D1 ø 17mm D2 ø 13mm | | |

hot air fans

miscellaneous



1

| | | | |
|--------------------|--|-----------------|--------------------------------|
| No. | 602133 | Ref. No. | 6252.00072.09 7AYS.00008.09 |
| description | fan 220/240V 38W L1 67mm L2 3mm L3 8mm L4 86mm fan wheel ø 85mm ROTTECH type SP-25-AF001 50/60Hz | | |



1

| | | | |
|--------------------|--|-----------------|---------------|
| No. | 602032 | Ref. No. | 6252.00072.10 |
| description | fan motor 220-240V 38W 1600rpm L1 72mm L2mm L3mm L4 86mm | | |

motors

gear motors

for dishwashers







| | | | |
|--------------------|---|-----------------|---------------|
| No. | 601874 | Ref. No. | 6262.00015.00 |
| description | gear motor AKSAN type AKWDKS 250W 380V voltage AC 50/60Hz 20rpm shaft ø 25mm L 370mm W 140mm H 235mm for dishwasher | | |
| For models: | OBK1500 | | |

pumps





wash and rinse pumps

LGB



| | | | | |
|---|--|-----------------|-----------------|---|
| No. | 499132 | Ref. No. | 9099.ZF121.00 | |
| description | pump inlet ø 28mm outlet ø 26mm type ZF121SX 230V 50Hz 1 phase 0.11kW 0.15HP L 195mm rotation direction right capacitor 6.3µF LGB | | | |
| spare parts for | 499132 | | | |
|  | No. | 365012 | Ref. No. | — |
| | operating capacitor capacity 6.3µF 450V tolerance 5% 50Hz ambient temperature max. -25 to +85°C ø 30mm L 61mm M8 plastic connection male faston 6.3mm protection | | | |
|  | No. | 510703 | Ref. No. | — |
| | mechanical shaft seal for shaft ø 13mm slide ring H 13mm height counter ring 5.5mm ED ø 26mm | | | |
|  | No. | 521057 | Ref. No. | — |
| | pump cover LGB inlet ø 28mm outlet ø 26mm auxiliary pressure connection 12mm supporting pressure open turn direction right ø 102mm ID ø 77mm inner height 31mm | | | |
|  | No. | 521085 | Ref. No. | — |
| | impellor ø 72mm H 17mm thread M7L shaft ø 13mm shaft length 12mm blades 3 | | | |
|  | No. | 528800 | Ref. No. | — |
| | O-ring EPDM thickness 2.62mm ID ø 75.87mm Qty 1 pcs | | | |



| | | | | |
|---|--|-----------------|-----------------|---|
| No. | 499306 | Ref. No. | 9099.ZF650.00 | |
| description | pump inlet ø 50mm outlet ø 48mm type ZF650SX 230V 50Hz 1 phase 1.47kW L 340mm rotation direction right LGB | | | |
| For models: | OBK1500 | | | |
| spare parts for | 499306 | | | |
|  | No. | 365019 | Ref. No. | — |
| | operating capacitor capacity 20µF 400V tolerance 5% 50/60Hz ambient temperature max. -25 to +85°C ø 39.5mm L 70mm M8 plastic connection male faston 6.3mm 16.10.25. protection | | | |
|  | No. | 510551 | Ref. No. | — |
| | pump cover gasket ID ø 158.3mm pump type 1214/1293/1225/2243/1226/1204/3473/1241 thickness 3.53mm EPDM Qty 1 pcs | | | |
|  | No. | 510694 | Ref. No. | — |
| | mechanical shaft seal for shaft ø 13mm height counter ring 8mm ID ø 11.5mm H 16mm mounting ø 24/26mm int. ø 1 14mm | | | |
|  | No. | 521108 | Ref. No. | — |
| | pump cover LGB inlet ø 50mm outlet ø 50mm auxiliary pressure connection 12mm | | | |
|  | No. | 521240 | Ref. No. | — |
| | impellor ø 110mm H 32mm rotation direction left thread M8L shaft ø 20mm shaft length 10mm seat ø 8.2mm blades 6 | | | |

booster pumps I



| | | | | |
|---|--|-----------------|-----------------|---|
| No. | 500540 | Ref. No. | 6262.00012.01 | |
| description | pump inlet ø 1" IT outlet ø 1" IT type PKM60 230V 50Hz 1 phase 0.37kW PEDRELLO 0.5HP | | | |
| For models: | OBK1500 | | | |
| accessories for | 500540 | | | |
|  | No. | 365015 | Ref. No. | — |
| | operating capacitor capacity 10µF 400V tolerance 5%Hz ambient temperature max. -25 to +85°C ø 35.5mm L 59mm M8 plastic connection male faston 6.3mm protection | | | |



drain pumps

ASKOLL



1

| | | | |
|-------------|---|----------|---------------|
| No. | 499349 | Ref. No. | 6262.00016.00 |
| description | drain pump 40W 220-240V inlet ø 30mm outlet ø 24mm 50Hz ASKOLL type M231 XP | | |



1

| | | | |
|-------------|---|----------|---------------|
| No. | 499315 | Ref. No. | 6262.00016.00 |
| description | drain pump inlet ø 24/30/35/39mm outlet ø 22/31mm 230V 40W 50Hz ASKOLL type M231 XP kit | | |

gas taps





PEL

20S series



1

| | | | |
|---|---|----------|--------------------------------|
| No. | 101094 | Ref. No. | 9GEV.10109.40 9PEL.10109.40 |
| description | gas tap PEL type 20S gas inlet M16x1.5 (tube ø 10mm) bypass nozzle ø 0.35mm gas outlet M16x1.5 (tube ø 10/8mm) thermocouple connection M8x1 pilot connection shaft ø 8x6.5mm shaft L 22/15mm shaft flat lower | | |
| spare parts for | 101094 | | |
|  | No. | 100408 | Ref. No. — |
| | bypass nozzle type PEL20/21 bore ø 0.35mm thread M5x0.5 | | |
|  | No. | 101060 | Ref. No. — |
| | magnet unit standard L 39mm D1 ø 15.4mm D2 ø 11mm suitable for PEL20-21/JUNKERS/EGA | | |
|  | No. | 101205 | Ref. No. — |
| | gas tap front part shaft ø 8x6.5mm shaft L 22/15mm shaft flat upper/lower suitable for PEL20 | | |
|  | No. | 101230 | Ref. No. — |
| | thermocouple nut T1: M8x1 T2: M18x1 aluminium | | |
| accessories for | 101094 | | |
|  | No. | 101278 | Ref. No. — |
| | olive for pipe ø 10mm Qty 1 pcs | | |

| | | | |
|---|---|--------|------------|
| accessories for | 101094 | | |
|  | No. | 101300 | Ref. No. — |
| | union nut thread M16x1.5 tube ø 10mm | | |
|  | No. | 101450 | Ref. No. — |
| | olive for pipe ø 8mm L 12.7mm Qty 1 pcs ED ø 10mm | | |
|  | No. | 101451 | Ref. No. — |
| | union nut thread M16x1.5 tube ø 8mm | | |
|  | No. | 110081 | Ref. No. — |
| | knob ø 70mm shaft ø 8x6.5mm shaft flat universal | | |
|  | No. | 110083 | Ref. No. — |
| | knob dial plate gas tap without ignition flame silver | | |

21S series







1

| | | | |
|---|---|----------|---------------|
| No. | 101095 | Ref. No. | 9PEL.10109.50 |
| description | gas tap PEL type 21S gas inlet M16x1.5 (tube ø 10mm) bypass nozzle ø 0.35mm gas outlet M16x1.5 (tube ø 10/8mm) thermocouple connection M8x1 pilot connection M10x1 shaft ø 8x6.5mm shaft L 22/15mm shaft flat lower | | |
| spare parts for | 101095 | | |
|  | No. | 100408 | Ref. No. — |
| | bypass nozzle type PEL20/21 bore ø 0.35mm thread M5x0.5 | | |
|  | No. | 101060 | Ref. No. — |
| | magnet unit standard L 39mm D1 ø 15.4mm D2 ø 11mm suitable for PEL20-21/JUNKERS/EGA | | |
|  | No. | 101206 | Ref. No. — |
| | gas tap front part shaft ø 8x6.5mm shaft L 22/15mm shaft flat upper/lower suitable for PEL21 | | |
|  | No. | 101230 | Ref. No. — |
| | thermocouple nut T1: M8x1 T2: M18x1 aluminium | | |
| accessories for | 101095 | | |
|  | No. | 100908 | Ref. No. — |
| | union screw thread M10x1 for pipe ø 4mm Qty 1 pcs | | |
|  | No. | 100909 | Ref. No. — |
| | union screw thread M10x1 for pipe ø 6mm Qty 1 pcs | | |
|  | No. | 101246 | Ref. No. — |
| | olive for pipe ø 4mm Qty 1 pcs | | |
|  | No. | 101278 | Ref. No. — |
| | olive for pipe ø 10mm Qty 1 pcs | | |
|  | No. | 101286 | Ref. No. — |
| | olive ID ø 6mm Qty 1 pcs | | |

Table continues overleaf



| accessories for | | 101095 | | |
|---|---|----------|---|--|
| No. | 101300 | Ref. No. | — | |
|  | union nut thread M16x1.5 tube ø 10mm | | | |
| No. | 101450 | Ref. No. | — | |
|  | olive for pipe ø 8mm L 12.7mm Qty 1 pcs ED ø 10mm | | | |
| No. | 101451 | Ref. No. | — | |
|  | union nut thread M16x1.5 tube ø 8mm | | | |
| No. | 110081 | Ref. No. | — | |
|  | knob ø 70mm shaft ø 8x6.5mm shaft flat universal | | | |
| No. | 112206 | Ref. No. | — | |
|  | knob dial plate silver gas tap PEL21/22/23 t.max.°C ED ø 63mm ID ø 45.5mm | | | |

AB

gas taps



1

| No. | 107905 | Ref. No. | N/A | |
|--------------------|--|----------|-----|--|
| description | gas tap AB type A60 gas inlet M16x1.5 (tube ø 10mm) gas outlet M16x1.5 (tube ø 10mm) thermocouple connection M9x1 pilot connection M10x1 front fixing shaft ø 8x6.5mm shaft L 22/15mm shaft flat lower | | | |



1



| No. | 107910 | Ref. No. | N/A | |
|--------------------|--|----------|-----|--|
| description | gas tap AB type A62 gas inlet M20x1.5 (tube ø 12mm) gas outlet M20x1.5 (tube ø 12/10mm) thermocouple connection M9x1 pilot connection M10x1 front fixing shaft ø 10x8mm shaft L 26/16mm shaft flat lower | | | |

ECA



1

| No. | 109096 | Ref. No. | 62670000503 | |
|---|---|----------|-------------|--|
| description | gas tap ECA gas inlet pipe flange ø21mm bypass nozzle ø 0.55mm gas outlet 1/4" (tube ø 8mm) thermocouple connection M8x1 shaft ø 8x6.5mm shaft L 19/13mm shaft flat upper front fixing M13x1 mounting thread M5 | | | |
| spare parts for | 109096 | | | |
| No. | 101051 | Ref. No. | — | |
|  | magnet unit L 27mm D1 ø 12.5mm D2 ø 8.5mm suitable for JUNKERS/EGA/MADEC/SABAF standard | | | |

| accessories for | | 109096 | | |
|---|------------------------------------|----------|---|--|
| No. | 101277 | Ref. No. | — | |
|  | olive ID ø 8mm Qty 1 pcs | | | |
| No. | 101351 | Ref. No. | — | |
|  | mounting strap for gas tap | | | |
| No. | 520656 | Ref. No. | — | |
|  | union nut thread 1/4" tube ø 6/8mm | | | |

gas thermostats

SIT

710 Minisit series



1

| No. | 103262 | Ref. No. | 9099.07106.53 | |
|---|--|----------|---------------|--|
| description | gas thermostat SIT type MINISIT 710 t.max. 270°C 70-270°C gas inlet 1/2" gas outlet 3/8" thermocouple connection M9x1 pilot connection M10x1 probe ø 5mm probe L 104mm capillary pipe 1050mm probe type type B1 pressure controller no | | | |
| accessories for | 103262 | | | |
| No. | 110068 | Ref. No. | — | |
|  | knob suitable for Minisit ø 37mm | | | |

PEL

25ST series



1







| No. | 101172 | Ref. No. | 90991011720 9PEL.10117.20 | |
|---|---|----------|------------------------------|--|
| description | gas thermostat PEL type 25ST 100-300°C gas inlet M16x1.5 (tube ø 10mm) bypass nozzle ø 0.35mm gas outlet M16x1.5 (tube ø 10/8mm) thermocouple connection M9x1 pilot connection M10x1 capillary pipe 1200mm probe ø 6mm probe L 100mm shaft ø 8x6.5mm shaft L 21/15mm shaft flat upper | | | |
| spare parts for | 101172 | | | |
| No. | 100259 | Ref. No. | — | |
|  | bypass nozzle type PEL22 bore ø 0.35mm thread M6x0.5 | | | |
| No. | 101060 | Ref. No. | — | |
|  | magnet unit standard L 39mm D1 ø 15.4mm D2 ø 11mm suitable for PEL20-21/JUNKERS/EGA | | | |
| No. | 106200 | Ref. No. | — | |
|  | nut thread M9x1 suitable for PEL 24/25S | | | |

Table continues overleaf



| accessories for | | 101172 | | |
|---|----------|----------|---|--|
| No. | Ref. No. | | | |
|  | 100908 | Ref. No. | — | |
| union screw thread M10x1 for pipe ø 4mm Qty 1 pcs | | | | |
|  | 100909 | Ref. No. | — | |
| union screw thread M10x1 for pipe ø 6mm Qty 1 pcs | | | | |
|  | 101246 | Ref. No. | — | |
| olive for pipe ø 4mm Qty 1 pcs | | | | |
|  | 101278 | Ref. No. | — | |
| olive for pipe ø 10mm Qty 1 pcs | | | | |
|  | 101286 | Ref. No. | — | |
| olive ID ø 6mm Qty 1 pcs | | | | |
|  | 101300 | Ref. No. | — | |
| union nut thread M16x1.5 tube ø 10mm | | | | |
|  | 101450 | Ref. No. | — | |
| olive for pipe ø 8mm L 12.7mm Qty 1 pcs ED ø 10mm | | | | |
|  | 101451 | Ref. No. | — | |
| union nut thread M16x1.5 tube ø 8mm | | | | |
|  | 110079 | Ref. No. | — | |
| knob dial plate gas thermostat 1-8 silver | | | | |
|  | 110081 | Ref. No. | — | |
| knob ø 70mm shaft ø 8x6.5mm shaft flat universal | | | | |

COPRECI

|  | | | |
|---|--|---------------|------------|
| 1 | | | |
| No. | Ref. No. | 6267.00005.22 | |
| description | gas thermostat E.C.A./COPRECI 100-300°C gas inlet pipe flange ø21mm bypass nozzle ø 0.45mm gas outlet M14x1.5 pilot connection thermocouple connection M8x1 capillary pipe 840mm probe ø 4.5mm probe L 92mm shaft ø 6x4.6mm shaft L 27/14mm shaft flat lower | | |
| spare parts for | 109089 | | |
|  | No. | 101060 | Ref. No. — |
| magnet unit standard L 39mm D1 ø 15.4mm D2 ø 11mm suitable for PEL20-21/JUNKERS/EGA | | | |
|  | No. | 101537 | Ref. No. — |
| gasket ID ø 8mm ED ø 11.5mm H 3mm Qty 1 pcs | | | |
| accessories for | 109089 | | |
|  | No. | 101538 | Ref. No. — |
| clamp | | | |



gas valves and ignition boxes

gas control valves

HONEYWELL

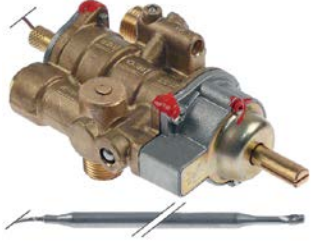
AB

|  | | | |
|---|---|--------------|--|
| 1 | | | |
| No. | Ref. No. | 03A00033 N/A | |
| description | gas thermostat AB type A65T 100-300°C gas inlet M16x1.5 (tube ø 10mm) gas outlet M16x1.5 (tube ø 10/8mm) thermocouple connection M9x1 pilot connection M10x1 capillary pipe 36" - 915mm probe ø 5.3mm probe L 138mm shaft ø 8x6.15mm shaft L 26/15mm shaft flat lower | | |

|  | | | |
|---|--|---------------|------------|
| 1 | | | |
| No. | Ref. No. | 6267.00005.30 | |
| description | gas valve type VK4105C 220-240V 50/60Hz gas inlet flange 32x32mm gas outlet flange 32x32mm thermocouple connection pilot connection pressure range 15-60mbar max 60mbar operator type pressure controller type V5306E 1234 1 suitable for HONEYWELL flange 32x32mm | | |
| accessories for | 106004 | | |
|  | No. | 102845 | Ref. No. — |
| gas connection angled 1/2" flange 32x32mm hole distance 24x24mm Tandem | | | |
|  | No. | 102846 | Ref. No. — |
| gas connection straight 1/2" flange 32x32mm hole distance 24x24mm suitable for Tandem | | | |

ignition boxes

HONEYWELL

Honeywell



| | | | | |
|-------------|---|--------|----------|----------------|
| 1 | No. | 102343 | Ref. No. | 6259.00020.061 |
| description | ignition box HONEYWELL type S4565A 2019 1 electrodes 2 waiting times safety time 10s 220-240V 4VA 50/60Hz | | | |

| | | | | |
|---|---|--------|----------|---|
| accessories for | 106907 | | | |
| | No. | 100245 | Ref. No. | — |
|  | pilot burner nozzle LPG code 20 bore ø 0.2mm Qty 1 pcs thread M8x0.75 | | | |
| | No. | 100904 | Ref. No. | — |
|  | locking screw M10x1 for pipe ø 4mm Qty 1 pcs | | | |
| | No. | 100905 | Ref. No. | — |
|  | locking screw M10x1 for pipe ø 6mm Qty 1 pcs | | | |
| | No. | 102110 | Ref. No. | — |
|  | pilot tube copper pipe ø 4mm thickness 1mm L 3000mm | | | |
| | No. | 102111 | Ref. No. | — |
|  | pilot tube copper pipe ø 6mm thickness 1mm L 3000mm | | | |
| | No. | 107171 | Ref. No. | — |
|  | pilot burner nozzle SIT natural/liquid gas bore ø 0.25mm Qty 1 pcs | | | |
| | No. | 107700 | Ref. No. | — |
|  | pilot burner bottom part SIT 100 series nozzle ø 0.25mm | | | |
| | No. | 107701 | Ref. No. | — |
|  | pilot burner bottom part SIT 100 series nozzle ø 0.2mm | | | |









ignition parts

pilot burners

SIT

100 series



| | | | | |
|---|--|--------|----------|---------------|
| 1 | No. | 106907 | Ref. No. | 6267.00023.07 |
| description | pilot burner SIT type 100 series 3 flames nozzle ø 0.35mm gas connection 6mm | | | |
| spare parts for | 106907 | | | |
| | No. | 100246 | Ref. No. | — |
|  | pilot burner nozzle natural gas bore ø 0.35mm Qty 1 pcs thread M8x0.75 | | | |
| | No. | 100855 | Ref. No. | — |
|  | pilot burner bracket triple | | | |
| | No. | 100885 | Ref. No. | — |
|  | air mixing sleeve for pilot burner Qty 1 pcs | | | |
| | No. | 100916 | Ref. No. | — |
|  | compression spring for pilot burner Qty 1 pcs | | | |
| | No. | 100917 | Ref. No. | — |
|  | gasket for pilot burner Qty 1 pcs aluminium | | | |
| | No. | 100918 | Ref. No. | — |
|  | screw for pilot burner | | | |
| | No. | 107162 | Ref. No. | — |
|  | pilot burner cap SIT 3 flames Hmm Lmm Qty 1 pcs | | | |
| | No. | 107702 | Ref. No. | — |
|  | pilot burner bottom part SIT 100 series nozzle ø 0.35mm | | | |

ERTA











| | | | | |
|---|--|--------|----------|---------------|
| 1 | No. | 102975 | Ref. No. | 6267.00023.03 |
| description | pilot burner 2 flames natural gas code 14 gas connection 6mm right | | | |
| spare parts for | 102975 | | | |
| | No. | 100234 | Ref. No. | — |
|  | pilot burner nozzle natural gas gas pressure 20mbar code 14 Qty 1 pcs suitable for JUNKERS CB5050_ | | | |
| | No. | 100701 | Ref. No. | — |
|  | ignition electrode connection M4 Qty 1 pcs | | | |
| | No. | 100906 | Ref. No. | — |
|  | screw connection thread M10x1 for ignition electrode brass Qty 1 pcs WS 10 | | | |
| | No. | 100909 | Ref. No. | — |
|  | union screw thread M10x1 for pipe ø 6mm Qty 1 pcs | | | |
| | No. | 101288 | Ref. No. | — |
|  | olive for pipe ø 6mm L 6mm aluminium Qty 1 pcs ED ø 8.5mm | | | |
| accessories for | 102975 | | | |
| | No. | 100217 | Ref. No. | — |
|  | pilot burner nozzle LPG gas pressure 30mbar code 3 Qty 1 pcs suitable for JUNKERS CB5050_ | | | |
| | No. | 101282 | Ref. No. | — |
|  | olive for pipe ø 4mm L 7.4mm Qty 1 pcs | | | |

Table continues overleaf





| | | | | |
|---|---|--------|----------|---|
| accessories for | 102975 | | | |
|  | No. | 101283 | Ref. No. | — |
| | union screw thread M10x1 for pipe ø 4mm Qty 1 pcs | | | |

ignition cables

pre-assembled cables

| | | | | |
|---|---|----------|---------------|--|
| 1  | | | | |
| No. | 102150 | Ref. No. | 6267.00031.07 | |
| description | ignition cable cable length 1500mm connection ø2.4mm / ø4mm | | | |

| | | | | |
|---|--|----------|---------------|--|
| 1  | | | | |
| No. | 100140 | Ref. No. | 6267.00031.01 | |
| description | ignition cable cable length 400mm connection ø2.4mm / ø4mm | | | |

| | | | | |
|---|--|----------|---------------|--|
| 1  | | | | |
| No. | 100019 | Ref. No. | 6267.00031.05 | |
| description | ignition cable cable length 900mm connection ø2.4mm / ø4mm | | | |

piezoelectric igniters

mounting diameter 18mm

| | | | | |
|---|--|----------|-------------|--|
| 1  | | | | |
| No. | 100003 | Ref. No. | 9GEV1000030 | |
| description | piezoelectric igniter body metal blowing mounting ø 18mm connection F2.8x0.8 | | | |

thermocouples

plug-in thermocouples

plug-in thermocouples standard

with barrel socket ø6(6.5)mm

thermocouples SIT

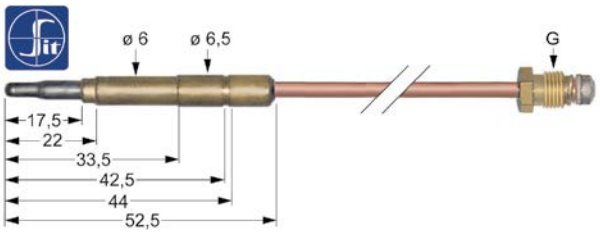
| | | | | |
|---|--|----------|---------------|--|
| 1  | | | | |
| No. | 107604 | Ref. No. | 6267.00024.04 | |
| description | thermocouple SIT M8x1 L 1200mm plug connection ø6.0(6.5)mm | | | |

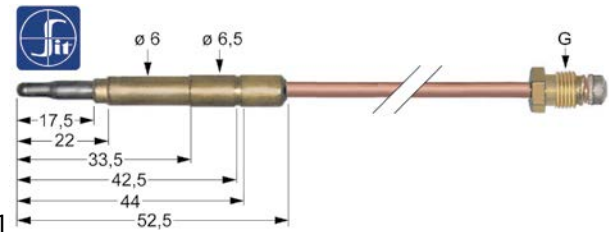
| | | | | |
|--|--|----------|-------------------------------|--|
| 1  | | | | |
| No. | 107613 | Ref. No. | 6267.00024.07 T1005191200E | |
| description | thermocouple SIT M9x1 L 1200mm plug connection ø6.0(6.5)mm | | | |

gas burners

hob burners

producer-specific hob burners

ÖZTIRYAKILER

stockpot stoves

| | | | | |
|--|----------------|----------|-------------|--|
| 1  | | | | |
| No. | 104195 | Ref. No. | 62670000101 | |
| description | burner ø 150mm | | | |

| | | | | |
|--|----------------|----------|-------------|--|
| 1  | | | | |
| No. | 104308 | Ref. No. | 62670000104 | |
| description | burner ø 250mm | | | |

equipment-specific units

for potato peelers

drive shafts

| | | | | |
|--|---|----------|---------------|--|
| 1  | | | | |
| No. | 696573 | Ref. No. | 2840.00010.66 | |
| description | drive shaft lower for potato peeler device ø 35mm L 141mm PSM10 | | | |
| For models: | PSM10 | | | |



1

| | | | |
|--------------------|---|-----------------|---------------|
| No. | 696574 | Ref. No. | 2840.00020.24 |
| description | drive shaft lower for potato peeler device ø 41mm L 184mm PSM20 | | |
| For models: | PSM20 | | |



1

| | | | |
|--------------------|---|-----------------|---------------|
| No. | 696575 | Ref. No. | 2840.00030.17 |
| description | drive shaft lower for potato peeler device ø 41mm L 187mm PSM30 | | |

lids



1

| | | | |
|--------------------|--|-----------------|---------------|
| No. | 696578 | Ref. No. | 6261.00013.10 |
| description | lid for potato peeler device ø 410mm ID ø 330mm plastic mounting distance mm PSM10 H 100mm | | |
| For models: | PSM10 | | |



1

| | | | |
|--------------------|---|-----------------|---------------|
| No. | 696563 | Ref. No. | 2840.00010.54 |
| description | lid for potato peeler device ø 410mm ID ø 330mm plastic mounting distance mm PSM10 H 79mm | | |
| For models: | PSM10 | | |



1

| | | | |
|--------------------|--|-----------------|---------------|
| No. | 696561 | Ref. No. | 2840.00020.08 |
| description | lid for potato peeler device ø 510mm ID ø 440mm plastic mounting distance 160mm PSM20 H 81mm | | |
| For models: | PSM20 | | |



1

| | | | |
|--------------------|--|-----------------|---------------|
| No. | 696562 | Ref. No. | 2840.00030.11 |
| description | lid for potato peeler device ø 610mm ID ø 540mm plastic mounting distance 155mm PSM30 H 82mm | | |
| For models: | PSM30 | | |

abrasive side elements

inserts



1

| | | | |
|--------------------|---|-----------------|---------------|
| No. | 696568 | Ref. No. | 6002.00015.00 |
| description | abrasive band for potato peeler device ø mm L 1210mm mounting distance mm PSM10 W 300mm | | |
| For models: | PSM10 | | |

grinding discs



1

| | | | |
|--------------------|--|-----------------|---------------|
| No. | 696565 | Ref. No. | 2840.00010.11 |
| description | grinding disc ø 365mm for potato peeler device PSM10 | | |
| For models: | PSM10 | | |



1

| | | | |
|--------------------|--|-----------------|---------------|
| No. | 696564 | Ref. No. | 2840.00010.56 |
| description | grinding disc ø 375mm for potato peeler device PSM10 | | |
| For models: | PSM10 | | |

1

| | | | |
|--------------------|--|-----------------|---------------|
| No. | 696566 | Ref. No. | 2840.00020.03 |
| description | grinding disc ø 460mm for potato peeler device PSM20 | | |
| For models: | PSM20 | | |



1

| | | | |
|--------------------|--|-----------------|---------------|
| No. | 696567 | Ref. No. | 2840.00030.03 |
| description | grinding disc ø 570mm for potato peeler device PSM30 | | |
| For models: | PSM30 | | |

accessories



1

| | | | |
|--------------------|---|-----------------|--------------------------------|
| No. | 696570 | Ref. No. | 2840.00020.20 2840.00030.12 |
| description | handle for grinding disc model PSM20/30 ø 88mm L 140mm bore ø 8mm | | |
| For models: | PSM20, PSM30 | | |

miscellaneous

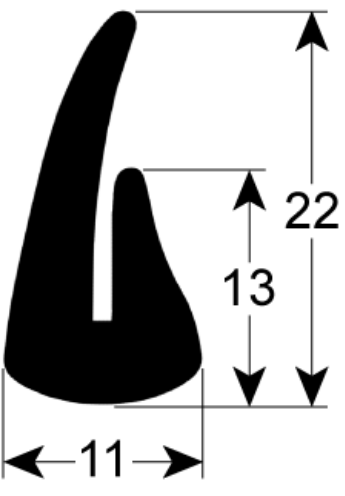

1

| | | | |
|--------------------|--|-----------------|---------------|
| No. | 696572 | Ref. No. | 6261.00010.10 |
| description | gasket for potato peeler device L 1320mm model PSM | | |
| For models: | PSM10 | | |



1

| | | | |
|--------------------|---|-----------------|---------------|
| No. | 696571 | Ref. No. | 6261.00010.03 |
| description | gasket for potato peeler device rubber L 205mm W 175mm H 17mm | | |
| For models: | PSM10 | | |



1

| | | | |
|--------------------|--|-----------------|---------------|
| No. | 696569 | Ref. No. | 2840.00010.51 |
| description | housing for potato peeler device plastic L 250mm W 210mm H 200mm | | |
| For models: | PSM10, PSM20, PSM30 | | |

accessories



1

| | | | |
|--------------------|---|-----------------|---------------|
| No. | 696577 | Ref. No. | 2840.00020.21 |
| description | coupling for drive shaft ID ø 41mm ED ø 70mm L 70mm for model PSM20 | | |
| For models: | PSM20 | | |



1

| | | | |
|--------------------|---|-----------------|---------------|
| No. | 696576 | Ref. No. | 2840.00030.04 |
| description | coupling for drive shaft ID ø 41mm ED ø 70mm L 70mm for model PSM30 | | |
| For models: | PSM30 | | |

for planetary mixers

gearboxes



| | | | |
|--------------------|---|-----------------|---------------|
| 1 | | | |
| No. | 698452 | Ref. No. | 2810.20200.26 |
| description | drive shaft for dough hook L 155mm ø 40mm model 20 litres | | |
| For models: | OM20G | | |



| | | | |
|--------------------|--|-----------------|--------------------------------|
| 1 | | | |
| No. | 698451 | Ref. No. | 2810.20200.17 6261.00018.52 |
| description | drive shaft for gearbox L 220mm ø 43mm | | |
| For models: | OM20G | | |



| | | | |
|--------------------|--|-----------------|---------------|
| 1 | | | |
| No. | 698441 | Ref. No. | 2810.00010.51 |
| description | internal gear for gearbox ø 170mm H 39mm model 10 litres | | |
| For models: | OM10G | | |

dough hooks



| | | | |
|--------------------|---|-----------------|---------------|
| 1 | | | |
| No. | 698425 | Ref. No. | 2810.00010.08 |
| description | dough hook model 10 litres shaft ø 16mm H 220mm | | |
| For models: | OM10G | | |



| | | | |
|--------------------|---|-----------------|---------------|
| 1 | | | |
| No. | 698424 | Ref. No. | 2810.20200.59 |
| description | dough hook model 20 litres shaft ø 22.5mm H 310mm | | |
| For models: | OM20G | | |



| | | | |
|--------------------|---|-----------------|---------------|
| 1 | | | |
| No. | 698423 | Ref. No. | 2810.40400.59 |
| description | dough hook model 40 litres shaft ø 29mm H 410mm | | |
| For models: | OM40G | | |



| | | | |
|--------------------|---|-----------------|---------------|
| 1 | | | |
| No. | 698422 | Ref. No. | 2810.60600.59 |
| description | dough hook model 60 liters shaft ø 29mm H 460mm | | |
| For models: | OM60G | | |

pulleys



| | | | |
|--------------------|---|-----------------|---------------|
| 1 | | | |
| No. | 698434 | Ref. No. | 2810.20200.33 |
| description | pulley bottom left disc ø 180mm ø 180mm shaft intake ø 32mm seat ø 54mm model 20 litres groove depth 65mm disc width 6mm overall width 56mm metal for planetary mixer | | |
| For models: | OM20G | | |



| | | | |
|--------------------|---|-----------------|---------------|
| 1 | | | |
| No. | 698440 | Ref. No. | 2810.40400.10 |
| description | pulley bottom left disc ø 205mm ø 205mm shaft intake ø 32mm seat ø 50mm model 40/60 litres groove depth 70mm disc width 45mm overall width 57mm metal for planetary mixer | | |
| For models: | OM40G, OM60G | | |



1

| | | | |
|--------------------|---|-----------------|---------------|
| No. | 698437 | Ref. No. | 2810.20200.10 |
| description | pulley bottom right disc ø 180mm ø 180mm shaft intake ø 14mm seat ø 33mm model 20 litres groove depth 65mm disc width 3mm overall width 110mm metal for planetary mixer | | |
| For models: | OM20G | | |



1

| | | | |
|--------------------|--|-----------------|---------------|
| No. | 698435 | Ref. No. | 2810.20200.34 |
| description | pulley upper left disc ø 180mm ø 180mm shaft intake ø 19mm seat ø 45mm model 20 litres groove depth 60mm disc width 5mm overall width 129mm metal for planetary mixer shaft ø 32mm | | |
| For models: | OM20G | | |



1

| | | | |
|--------------------|---|-----------------|---------------|
| No. | 698438 | Ref. No. | 2810.40400.33 |
| description | pulley bottom right disc ø 180mm ø 180mm shaft intake ø 23mm seat ø 45mm model 40 litres groove depth 65mm disc width 5mm overall width 130mm metal for planetary mixer | | |
| For models: | OM40G | | |



1

| | | | |
|--------------------|---|-----------------|---------------|
| No. | 698436 | Ref. No. | 2810.20200.09 |
| description | pulley upper right disc ø 180mm ø 180mm shaft intake ø 32mm seat ø 50mm model 20 litres groove depth 65mm disc width 6mm overall width 60mm metal for planetary mixer | | |
| For models: | OM20G | | |



1

| | | | |
|--------------------|---|-----------------|---------------|
| No. | 698439 | Ref. No. | 2810.40400.34 |
| description | pulley upper right disc ø 180mm ø 180mm shaft intake ø 35mm seat ø 54mm model 40 litres groove depth 67mm disc width 6mm overall width 56mm metal for planetary mixer | | |
| For models: | OM40G | | |

beaters



| | | | | |
|---|--------------------|---|-----------------|---------------|
| 1 | No. | 698420 | Ref. No. | 2810.00010.13 |
| | description | beater model 10 litres shaft ø 16mm W 155mm H 210mm | | |
| | For models: | OM10G | | |



| | | | | |
|---|--------------------|---|-----------------|--------------------------------|
| 1 | No. | 698421 | Ref. No. | 2810.00020.50 2810.20200.58 |
| | description | beater model 20 litres shaft ø 22.5mm W 185mm H 310mm | | |
| | For models: | OM20G | | |



| | | | | |
|---|--------------------|---|-----------------|---------------|
| 1 | No. | 698427 | Ref. No. | 2810.40400.58 |
| | description | beater model 40 litres shaft ø 29mm W 240mm H 305mm | | |
| | For models: | OM40G | | |



| | | | | |
|---|--------------------|---|-----------------|---------------|
| 1 | No. | 698426 | Ref. No. | 2810.60600.58 |
| | description | beater model 60 litres shaft ø 29mm W 300mm H 330mm | | |
| | For models: | OM60G | | |

mixer bowls



| | | | | |
|---|--------------------|--|-----------------|---------------|
| 1 | No. | 698432 | Ref. No. | 2810.00010.31 |
| | description | mixer bowl model 10 litres ø 280mm H 205mm | | |
| | For models: | OM10G | | |



| | | | | |
|---|--------------------|--|-----------------|---------------|
| 1 | No. | 698433 | Ref. No. | 2810.20200.49 |
| | description | mixer bowl model 20 litres ø 340mm H 275mm | | |
| | For models: | OM20G | | |

beaters



| | | | | |
|---|--------------------|--|-----------------|---------------|
| 1 | No. | 698428 | Ref. No. | 2810.00010.16 |
| | description | whisk model 10 litres shaft ø 16mm ø 120mm H 220mm | | |
| | For models: | OM10G | | |



| | | | | |
|---|--------------------|--|-----------------|---------------|
| 1 | No. | 698431 | Ref. No. | 2810.20200.57 |
| | description | whisk model 20 litres shaft ø 22.5mm ø 175mm H 310mm | | |
| | For models: | OM20G | | |



| | | | | |
|---|--------------------|--|-----------------|---------------|
| 1 | No. | 698429 | Ref. No. | 2810.40400.57 |
| | description | whisk model 40 litres shaft ø 29mm ø 235mm H 400mm | | |
| | For models: | OM40G | | |



| | | | | |
|---|--------------------|--|-----------------|--------------------------------|
| 1 | No. | 698430 | Ref. No. | 2810.00060.17 2810.60600.57 |
| | description | whisk model 60 litres shaft ø 29mm ø 265mm H 460mm | | |
| | For models: | OM60G | | |

gear wheels



1

| | | | |
|--------------------|---|-----------------|---------------|
| No. | 698448 | Ref. No. | 6261.00017.22 |
| description | gear wheel ø 52mm shaft intake ø 15mm W 24mm teeth 23 polyamide for model 10 litres | | |
| For models: | OM10G | | |



1

| | | | |
|--------------------|---|-----------------|---------------|
| No. | 698450 | Ref. No. | 2810.20200.23 |
| description | gear wheel ø 52mm shaft intake ø 18mm W 32mm teeth 18 polyamide for model 20 litres | | |
| For models: | OM20G | | |



1

| | | | |
|--------------------|--|-----------------|---------------|
| No. | 698449 | Ref. No. | 2810.40400.23 |
| description | gear wheel ø 60mm shaft intake ø 24mm W 40mm teeth 15 polyamide for model 40/60 litres | | |
| For models: | OM40G, OM60G | | |

for espresso machines

brewing units

filter holder gaskets

O-rings



1

| | | | |
|--------------------|---|-----------------|---------------|
| No. | 510409 | Ref. No. | 6228.00002.14 |
| description | O-ring EPDM thickness 5.34mm ID ø 56.52mm Qty 1 pcs | | |

for saladettes

housing and bezels



1

| | | | |
|--------------------|---|-----------------|---------------------------------------|
| No. | 692115 | Ref. No. | 2912.16894.W0.750.00 7AYS.00002.19 |
| description | cover housing L 413mm H 337mm plate thickness max. 30mm | | |

for dishwashers

drain and intake components

ÖZTIRYAKILER

overflow pipes



1

| | | | |
|--------------------|------------------------------|-----------------|----------------|
| No. | 517824 | Ref. No. | 6262.00028.001 |
| description | overflow pipe L 200mm ø 40mm | | |

miscellaneous

drain /intake bodies



| | | | |
|--------------------|------------------------|-----------------|----------------|
| 1 | | | |
| No. | 517766 | Ref. No. | 6262.00027.000 |
| description | drain unit with filter | | |
| For models: | OBK1500 | | |

overflow pipes



| | | | |
|--------------------|------------------------------|-----------------|--|
| 1 | | | |
| No. | 517765 | Ref. No. | 2710.20051.450 6262.00028.02 6262.00028.02+6228.00001.36 |
| description | overflow pipe L 400mm ø 41mm | | |
| For models: | OBK1500 | | |

housing and bezels

model name plates



| | | | |
|--------------------|--|-----------------|---------------|
| 1 | | | |
| No. | 694812 | Ref. No. | 2999.NOVAT.LO |
| description | type plate NOVATEC metal L 70mm W 32mm | | |

miscellaneous



| | | | |
|--------------------|--|-----------------|---------------|
| 1 | | | |
| No. | 506160 | Ref. No. | 6215.00001.03 |
| description | plain washer ID ø 8.6mm ED ø 16mm thickness 1.5mm SS Qty 1 pcs | | |

washing and rinsing systems



| | | | |
|--------------------|--|-----------------|--|
| 1 | | | |
| No. | 504857 | Ref. No. | 6262.00030.33 + 6262.00030.01 6262.00033.33 |
| description | wash and rinse arm wash arm L 510mm rinse arm L 510mm w. jets 10 r. jets 6 | | |

washing and rinsing systems (sorted by producer)

ÖZTIRYAKILER

rinse arm shafts



| | | | |
|--------------------|---------------------------------------|-----------------|-----------------------|
| 1 | | | |
| No. | 699582 | Ref. No. | 2KLP.460.626200041.04 |
| description | nut L 14.5mm M8x1 for rinse arm shaft | | |



| | | | |
|--------------------|---|-----------------|--|
| 1 | | | |
| No. | 699581 | Ref. No. | 2KLP.460.626200041.03 6262.00041.03 |
| description | rinse arm shaft L 67mm M8x1 ø 15mm hole ø 6mm | | |

wash arm supports



| | | | |
|--------------------|---|-----------------|---------------|
| 1 | | | |
| No. | 699580 | Ref. No. | 6262.00030.05 |
| description | tap head ø 110mm ID ø 46mm H 8mm for wash arm support | | |



1

| | | | |
|--------------------|--|-----------------|--------------------------------|
| No. | 513327 | Ref. No. | 2710.F0024.02 6262.00024.02 |
| description | wash arm support ø 46mm ID ø 40mm H 150mm 2" | | |

for plate dispensers



1

| | | | |
|--------------------|--|-----------------|---------------|
| No. | 501497 | Ref. No. | 6260.00022.00 |
| description | guide roller for plate dispensers W 27mm ø 30mm ID ø 8mm | | |

knobs

producer-specific knobs

ÖZTIRYAKILER



1

| | | | |
|--------------------|--|-----------------|-----------------------------|
| No. | 112748 | Ref. No. | 6260.00015.45+6260.00015.38 |
| description | knob 0-1-0-1 ø 75mm shaft ø 6x4.6mm shaft flat upper/lower black | | |



1

| | | | |
|--------------------|--|-----------------|--|
| No. | 112659 | Ref. No. | 6260.00015.40 6260.00015.46 6260.00015.46+6260.00015.40 62600001518 |
| description | knob gas tap with ignition flame ø 75mm shaft ø 8x6.5mm shaft flat upper/lower black | | |



1

| | | | |
|--------------------|---|-----------------|-----------------------------|
| No. | 112746 | Ref. No. | 6260.00015.45+6260.00015.37 |
| description | knob thermostat 30-90°C ø 75mm shaft ø 6x4.6mm shaft flat upper/lower black | | |



1

| | | | |
|--------------------|--|-----------------|-----------------------------|
| No. | 112747 | Ref. No. | 6260.00015.45+6260.00015.32 |
| description | knob thermostat 50-300°C ø 75mm shaft ø 6x4.6mm shaft flat upper/lower black | | |



1

| | | | |
|--------------------|--|-----------------|--|
| No. | 112661 | Ref. No. | 6260.00015.20 6260.00015.47+6260.00015.44 |
| description | knob without symbol ø 80mm shaft ø 10x8mm shaft flat upper/lower black | | |



1

| | | | |
|--------------------|--|-----------------|---------------|
| No. | 112809 | Ref. No. | 6262.00071.20 |
| description | knob zero mark ø 58mm shaft ø 6x5mm shaft flat upper | | |

handles and hand wheels

hand wheels

hand wheels



1

| | | | |
|--------------------|---|-----------------|---------------|
| No. | 694672 | Ref. No. | 6261.00028.52 |
| description | hand wheel \varnothing 190mm D1 \varnothing 43mm bore \varnothing 16mm depth of bore 21mm thread M10x1.5 groove width 5mm groove depth 21mm L1 20mm L2 35mm handle lengthmm | | |
| For models: | OM20G, OM40G, OM60G | | |

spare parts and accessories



1

| | | | |
|--------------------|---|-----------------|--------------------------------|
| No. | 514443 | Ref. No. | 2810.40400.31 6261.00028.78 |
| description | cone handle \varnothing 28mm total length 100mm thread M10x1.5 plastic L 81mm | | |
| For models: | OM20G, OM40G, OM60G | | |

cone handles



1

| | | | |
|--------------------|---|-----------------|--------------------------------|
| No. | 514443 | Ref. No. | 2810.40400.31 6261.00028.78 |
| description | cone handle \varnothing 28mm total length 100mm thread M10x1.5 plastic L 81mm | | |
| For models: | OM20G, OM40G, OM60G | | |

locks

edgemount latches

handle latches

producer-specific

ÖZTIRYAKILER

locks



1

| | | | |
|--------------------|--|-----------------|--------------------------------|
| No. | 701581 | Ref. No. | 6201.00031.01 7AYS.00008.04 |
| description | catch L 254mm mounting distance 116mm chrome-plated steel lockable | | |

hinges

door bearing



1

| | | | |
|--------------------|--|-----------------|---------------|
| No. | 701430 | Ref. No. | 6201.00030.50 |
| description | door guides L 80mm W 24mm H 115mm mounting pos. left/right | | |

pullouts

drawer slides

producer-specific



1

| | | | |
|--------------------|--|-----------------|---------------------------|
| No. | 692608 | Ref. No. | 2919.17NTS.00.910.00 left |
| description | drawer rail L 555mm pull-out lengthmm W 53mm H 15mm mounting pos. left | | |





1

| | | | |
|--------------------|--|-----------------|--|
| No. | 692678 | Ref. No. | 2919.17NTS.00.910.00 2919.17NTS.00.910.00 right |
| description | drawer rail L 555mm pull-out lengthmm W 53mm H 15mm pair | | |

fittings for catering equipment

drain taps

accessories



1

| | | | |
|--------------------|--|-----------------|---------------|
| No. | 540222 | Ref. No. | 6228.00059.60 |
| description | O-ring EPDM thickness 2.62mm ID ø 47.3mm Qty 1 pcs | | |

shelves and shelf rails

shelf rails and supports

producer-specific



1

| | | | |
|--------------------|--|-----------------|---------------|
| No. | 692607 | Ref. No. | 6260.00068.04 |
| description | pair of setting bar L 550mm W 60mm inner height 12mm hook width 15mm mounting distance 490mm | | |



1

| | | | |
|--------------------|--|-----------------|--------------------------|
| No. | 692605 | Ref. No. | siehe Bemerkung 03,08,16 |
| description | pair of setting bar L 725mm W 30mm inner height 13mm hook width 15mm | | |



1

| | | | |
|--------------------|---|-----------------|--------------------------|
| No. | 692606 | Ref. No. | siehe Bemerkung 03,08,16 |
| description | pair of setting bar U-shape L 660mm W 30mm inner height 13mm hook width 15mm mounting pos. left/right | | |

gaskets

refrigeration gaskets

plug-in gaskets

profile 9175

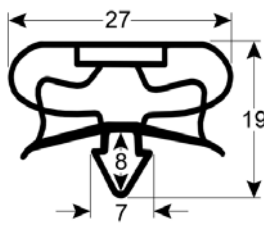

1

| | | | |
|--------------------|--|-----------------|---|
| No. | 902468 | Ref. No. | 6268.00012.26 6268.00012.30 7AYS.00008.21 |
| description | refrigeration gasket profile 9175 W 615mm L 1387mm plug size | | |

profile 9014

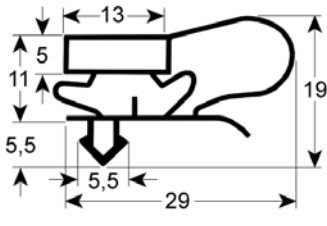

1

| | | | |
|--------------------|---|-----------------|---------------|
| No. | 902056 | Ref. No. | 6268.00012.10 |
| description | refrigeration gasket profile 9014 W 380mm L 585mm plug size | | |

profile 9141

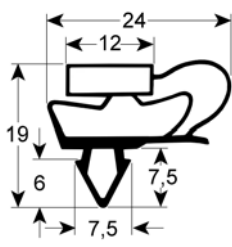

1

| | | | |
|--------------------|--|-----------------|---------------|
| No. | 901868 | Ref. No. | 6268.00012.32 |
| description | refrigeration gasket profile 9041 W 574mm L 1530mm external size | | |
| For models: | 7919.06LMV.00, 7919.06NMV.00, 7919.12LMV.00, 7919.12NMV.00 | | |



evaporators

for fridges

producer-specific



1

| | | | |
|--------------------|--|-----------------|---------------|
| No. | 750708 | Ref. No. | 6268.00011.60 |
| description | evaporator L 420mm W 235mm H 115mm suitable for GN 600 NMV | | |
| For models: | 7919.06NMV.00 | | |

transmission technology and ball bearings

ball bearings

deep-groove ball bearings 2RS



1

| | | | |
|--------------------|--|-----------------|---------------|
| No. | 523522 | Ref. No. | 6211.00210.01 |
| description | deep-groove ball bearing type 6004-2RS shaft \varnothing 20mm ED \varnothing 42mm W 12mm with sealing discs deep-groove ball bearing DIN 625-1 | | |
| For models: | OM10G | | |



1

| | | | |
|--------------------|--|-----------------|---------------|
| No. | 523518 | Ref. No. | 6211.00243.00 |
| description | deep-groove ball bearing type 6305-2RS shaft \varnothing 25mm ED \varnothing 62mm W 17mm with sealing discs deep-groove ball bearing DIN 625-1 | | |
| For models: | OM20G, OM40G, OM60G | | |

deep-groove ball bearings 2Z



1

| | | | |
|--------------------|---|-----------------|---------------|
| No. | 523032 | Ref. No. | 6211.00210.00 |
| description | deep-groove ball bearing shaft \varnothing 20mm ED \varnothing 42mm W 12mm type 6004-2Z DIN 625-1 | | |
| For models: | OM10G, PSM10 | | |



1

| | | | |
|--------------------|---|-----------------|---------------|
| No. | 523030 | Ref. No. | 6211.00222.00 |
| description | deep-groove ball bearing shaft \varnothing 30mm ED \varnothing 62mm W 16mm type 6206-2Z DIN 625-1 | | |
| For models: | PSM20, PSM30 | | |

drive belts

V-belts

profile A/13



1

| | | | |
|--------------------|--|-----------------|---------------|
| No. | 698444 | Ref. No. | 6263.00002.08 |
| description | V-belt belt width 13mm L 875mm H 8mm CODE A34 1/2 profile A/13 | | |
| For models: | OM10G | | |

toothed belts



1

| | | | |
|--------------------|--|-----------------|---------------|
| No. | 698442 | Ref. No. | 6263.00003.02 |
| description | toothed belt profile VX L 1025mm H 10mm teeth 150 splitting 5-4 rubber with textile insertion CODE 1025Li W 32mm | | |
| For models: | OM60G | | |



1

| | | | |
|--------------------|---|-----------------|---------------|
| No. | 698443 | Ref. No. | 6263.00003.11 |
| description | toothed belt profile VX L 820mm H 10mm teeth 82 splitting 8-4 rubber with textile insertion CODE 820Li W 32mm | | |
| For models: | OM20G | | |



1

| | | | |
|--------------------|---|-----------------|---------------|
| No. | 698447 | Ref. No. | 6263.00003.10 |
| description | toothed belt profile VX L 950mm H 10mm teeth 100 splitting 6-4 rubber with textile insertion CODE SD2006-002 W 32mm | | |
| For models: | OM40G | | |

poly-v belts



| | | | |
|--------------------|---|-----------------|---------------|
| No. | 698445 | Ref. No. | 6263.00006.01 |
| description | poly-v belt grooves 11 W 26mm L 559mm profile J | | |
| For models: | PSM10 | | |

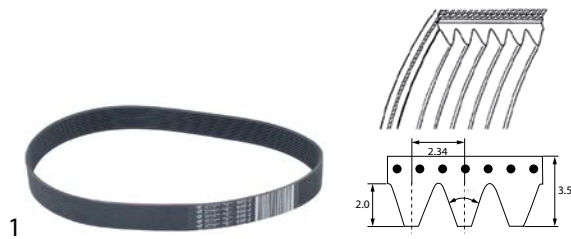

| | | | |
|--------------------|---|-----------------|---------------|
| No. | 698446 | Ref. No. | 6263.00006.02 |
| description | poly-v belt grooves 11 W 26mm L 660mm profile J | | |
| For models: | PSM20, PSM30 | | |

springs

tension springs



| | | | |
|--------------------|---|-----------------|---------------|
| No. | 501496 | Ref. No. | 6205.00001.01 |
| description | tension spring ø 14mm total length 139mm wire gauge ø 1.2mm | | |

dosing pumps

peristaltic dosing pumps

SEKO

built-in version

with frequency control



| | | | |
|--------------------|---|-----------------|---------------|
| No. | 361979 ¹ | Ref. No. | 6262.30666.14 |
| description | dosing pump SEKO frequency control 0.4l/h 230VAC rinse aid hose ø 4x6mm hose type D hose Sekobril type NBR 0.4 with inlet and conveyor hose | | |

¹with accessories

hoses

supply hoses

PVC supply hoses

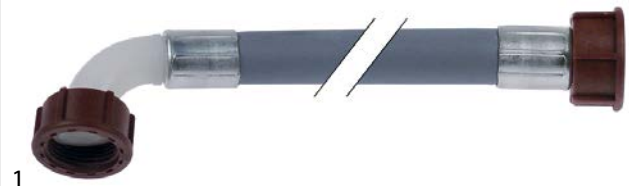

| | | | | |
|------------------------|--|-----------------|-----------------|---|
| No. | 520010 | Ref. No. | 6262.00021.12 | |
| description | supply hose PVC straight-curved DN13 connections 3/4" L 1500mm operating p. 10bar burst p. 32bar t.max. 90°C blue approval VDE flat seal | | | |
| For models: | OBK1500 | | | |
| accessories for | 520010 | | | |
| | No. | 520053 | Ref. No. | — |
| | screen connection 3/4" D1 ø 26mm D2 ø 15mm Qty 10 pcs rubber thickness 8mm | | | |
| | No. | 520054 | Ref. No. | — |
| | flat gasket rubber ED ø 23.5mm ID ø 14mm thickness 2.3mm Qty 10 pcs | | | |

drain hoses



| | | | |
|--------------------|--|-----------------|---------------|
| No. | 530872 | Ref. No. | 6262.00021.13 |
| description | drain hose DN31 L 2500mm A int. ø 40mm A ext. ø 47mm B int. ø 40mm B ext. ø 47mm | | |
| For models: | OBK1500 | | |

ittings, hose and pipe connectors

ittings

double nipples



| | | | |
|--------------------|--|-----------------|---------------|
| No. | 521192 | Ref. No. | 6222.00003.25 |
| description | double nipple brass thread 1"-3/4" Qty 1 pcs | | |







drain systems and wash basins

wash basins



1

| | | | |
|---|---|-----------------|-------------------|
| No. | 542317 | Ref. No. | 7759.54483.10 |
| description | hand-wash basin stainless steel W 500mm D 400mm H 390mm | | |
| accessories for | 542317 | | |
|  | No. | 515015 | Ref. No. — |
| | U-bend basins 1 thread 1½" flexible hose outflow distance max. 150mm spout ø 40mm | | |
|  | No. | 515045 | Ref. No. — |
| | drain fitting size 1½" usable heightmm overall height 41mm ED ø 70mm chrome-plated brass | | |
|  | No. | 515089 | Ref. No. — |
| | drain fitting size 1½" usable heightmm overall height 40mm ED ø 71mm stainless steel | | |
|  | No. | 515141 | Ref. No. — |
| | drain fitting size 1 1/2" usable heightmm overall heightmm ED ø 70mm SS/plastic with plug | | |

fastening material

screws

hexagonal screws



1

| | | | |
|--------------------|---|-----------------|---------------|
| No. | 550682 | Ref. No. | 6262.00003.10 |
| description | hexagonal screw thread M8 thread L 20mm SS WS 13 Qty 1 pcs DIN 933 / ISO 4017 | | |

nuts

plate nuts



1

| | | | |
|--------------------|--------------------------------------|-----------------|---------------|
| No. | 560573 | Ref. No. | 6214.00009.00 |
| description | plate nut hole ø 2.6mm L 17mm W 12mm | | |

hexagonal nuts

DIN 985



1

| | | | |
|--------------------|--|-----------------|---------------|
| No. | 560143 | Ref. No. | 6214.00013.15 |
| description | hexagonal nut thread M8 H 8.5mm SS WS 13 Qty 20 pcs DIN/ISO 985 self-locking | | |

washers

washers

miscellaneous



1

| | | | |
|--------------------|--|-----------------|---------------|
| No. | 506160 | Ref. No. | 6215.00001.03 |
| description | plain washer ID ø 8.6mm ED ø 16mm thickness 1.5mm SS Qty 1 pcs | | |

tooth lock washers

DIN 6798A



1

| | | | |
|--------------------|---|-----------------|---------------|
| No. | 503121 | Ref. No. | 6216.00015.05 |
| description | tooth lock washer ID ø 8.4mm ED ø 15mm SS Qty 1 pcs | | |

fasteners

mounting clips

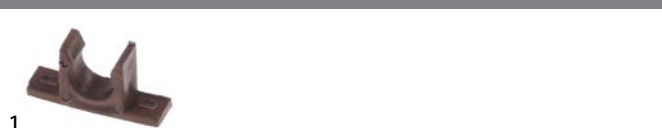

1

| | | | |
|--------------------|--|-----------------|-------------|
| No. | 524043 | Ref. No. | 7AYS0000220 |
| description | mounting clip plastic L 38mm W 19mm H 10mm | | |