

Professionall

Solutii profesionale pentru echipamente profesionale



GAS COMPONENTS



ELECTRIC COMPONENTS



WATER TECHNOLOGY



MECHANICAL COMPONENTS



TOOLS

Spare parts suitable for

MONDIAL



heating elements

heating elements for refrigeration

heating elements for defrosting



No.	419137	Ref. No.	4003116147000
description	heating element 1100W 230V L 1000mm W 70mm cable length 1800mm tube ø 8.5mm defrosting		



No.	417587	Ref. No.	TDE072220
description	heating element 350W 230V L 380mm Wmm Hmm cable length 3.3m tube ø 8.7mm		

heating cartridges



No.	417577	Ref. No.	1192081 (alternativ)
description	heating cartridge 190W 230V ø 12mm L 180mm thread 3/8" cable length 300mm suitable for MONDIAL		



No.	417571	Ref. No.	1192081
description	heating cartridge 230W 230V ø 12mm L 180mm thread 3/8" cable length 1000mm universal		

thermostats

refrigeration thermostats

RANCO

K50 series

RANCO



No.	390988	Ref. No.	1101031
description	thermostat RANCO type K50B-S3508 probe ø 2mm capillary pipe 1500mm		

RANCO



No.	390780	Ref. No.	1001086
description	thermostat RANCO type K50-L3085 probe ømm probe Lmm capillary pipe 1800mm		

RANCO



No.	390528	Ref. No.	1101043
description	thermostat RANCO type K50L3417 probe ø 10mm probe L 100mm capillary pipe 1400mm probe ø9.5x112mm		

RANCO



No.	390803	Ref. No.	1101005
description	thermostat RANCO type K50-P1569/001 probe L 50mm capillary pipe 900mm		

K54 series

RANCO



No.	390782	Ref. No.	1001118 1101001G
description	thermostat RANCO type K54L2097 probe ø 2mm capillary pipe 900mm		



ATEA



No.	390794	Ref. No.	1101028
description	thermostat ATEA type A01 0806 probe ø 10mm probe L 52mm capillary pipe 1150mm		



No.	390781	Ref. No.	1101029
description	thermostat T war -15°C T cold -32°C probe ø 2mm capillary pipe 2500mm type A01 0791		



No.	346377	Ref. No.	1014073
description	rocker switch mounting measurements 30x22mm black 2CO 230V 16A 0-I connection male faston 6.3mm ambient temperature max. 125/55°C protection IP40		

accessories for	346377			
	No.	301036	Ref. No.	—
	protective cover internal size 30x22mm for rocker switch mounting measurementsmm			

1

No.	301287	Ref. No.	1114001G 1114018
description	rocker switch mounting measurements 30x22mm orange 2NO 250V 16A illuminated 0-I connection male faston 6.3mm ambient temperature max. 100/55°C protection IP40		

switches and momentary switches

rocker/momentary rocker switches

30x22mm



No.	301002	Ref. No.	1014056
description	rocker switch mounting measurements 30x22mm orange 2NO 250V 16A illuminated 0-I connection male faston 6.3mm ambient temperature max. 85/125°C protection IP65		

accessories for	301002			
	No.	301036	Ref. No.	—
	protective cover internal size 30x22mm for rocker switch mounting measurementsmm			



No.	301009	Ref. No.	1114014
description	rocker switch mounting measurements 30x22mm white 2NO 250V 16A illuminated 0-I connection male faston 6.3mm ambient temperature max. 125/55°C protection IP65		

accessories for	301009			
	No.	301036	Ref. No.	—
	protective cover internal size 30x22mm for rocker switch mounting measurementsmm			

push/momentary push switches

ø16mm



No.	301295	Ref. No.	1114013
description	push switch mounting ø 16mm black 1NO 250V 16A connection male faston 6.3mm protection IP40 ambient temperature max. 150°C		

microswitches

with push button

switches with snap-fit



No.	348148	Ref. No.	1195012
description	microswitch with push button 250V 0.25A 1NO connection male faston 6.3mm L 26x12mm ambient temperature max. 85°C actuating force: 500g		
For models:	EBA01W540		



roller actuated

roller 90°



1

No.	347640	Ref. No.	1095001
description	microswitch with roller plunger 250V 16A connection male faston 6.3mm ambient temperature max. 85°C thread M12		

lamps

indicator lights

indicator lights (complete)

30x22mm



1

No.	359157	Ref. No.	1111002G
description	indicator light mounting measurements 30x22mm 230V green connection male faston 6.3mm temp.-resist. 125/55°C type RL2		
accessories for	359157		
	No.	301036	Ref. No.
			—
description	protective cover internal size 30x22mm for rocker switch mounting measurementsmm		



1

No.	347641	Ref. No.	10110141 1111001G
description	indicator light mounting measurements 30x22mm 230V red connection male faston 6.3mm		

fluorescent lamps

fluorescent lamps

G13



1

No.	359371	Ref. No.	1112007
description	fluorescent lamp socket G13 L 590mm 18W 230V Qty 1 pcs		

timers

defrost timers

CDC



1

No.	360193	Ref. No.	1186003
description	defrost timer CDC type 13102 defrosting interval 1-12x in 24h defrosting time 2-50min fan delay 0-10min 230V 50Hz defr. funct. 1-12x per 24h with delay of fan 0-10min		

miscellaneous



1

No.	360187	Ref. No.	1186010
description	defrost timer type RZ-2001-21 defrosting interval 4H defrosting time 15min fan delay 5min 230V 50Hz defr. funct. 4x per 24h		

relays

power relays

with bracket mounting



1

No.	380815	Ref. No.	1142005
description	power relays 230VAC 16A 2NO connection male faston 6.3mm flange dimensions 36x38x68mm		



1	No.	380185	Ref. No.	1042007
description power relays Italiana Relè 230VAC 30A 1NO connection F6.3 bracket mounting dimensions 36.5x32.2x51.8mm manuf. no. A10-230AC-FA				

electronic controllers

DIXELL

refrigeration controllers

built-in version



1	No.	378307	Ref. No.	1188054
description electronic controller DIXELL XR40C-5N1C1 mounting measurements 71x29mm 230V voltage AC NTC/PTC relay outputs 2 NO-20A(8) CO-8A(3) NTC/PTC DI protection IP54 0-60°C display 3½ digits				



1	No.	378020	Ref. No.	N/A
description electronic controller DIXELL XR760C-500C0 mounting measurements 71x29mm defr. funct. no				

TECNOLOGIC

universal controllers

built-in version



1	No.	379796	Ref. No.	1188053
description electronic controller TECNOLOGIC type TLZ11FR-21 mounting measurements 71x29mm 12V voltage AC/DC NTC/PTC relay outputs 1 CO-8A(3) NTC/PTC DI built-in depth 64mm defr. funct. no -50 up to +150°C display 4 digits				

refrigeration controllers

built-in version



1	No.	379206	Ref. No.	1088016
description electronic controller TECNOLOGIC type TDF11F mounting measurements 71x29mm 12V voltage AC/DC NTC/PTC/Pt100/Pt1000/TC(J,K) -50 up to +150°C display 2½ digit				

accessories for 379206				
	No.	379052	Ref. No.	—
temperature probe PTC 1kOhm cable silicone probe -50 up to +150°C cable -50 up to +180°C probe ø6x40mm cable length 1.5m without screw connection 2-wire				
	No.	379053	Ref. No.	—
temperature probe PTC 1kOhm cable PVC probe -50 up to +150°C cable -10 up to 100°C probe ø6x30mm cable length 3m without screw connection 2-wire				
	No.	379054	Ref. No.	—
transformer primary 230VAC secondary 12VAC 3VA secondary 0.25A H 40mm L 45mm W 50mm connection screw 50/60Hz type 153/M				



1	No.	379796	Ref. No.	1188053
description electronic controller TECNOLOGIC type TLZ11FR-21 mounting measurements 71x29mm 12V voltage AC/DC NTC/PTC relay outputs 1 CO-8A(3) NTC/PTC DI built-in depth 64mm defr. funct. no -50 up to +150°C display 4 digits				



			
1			
No.	378519	Ref. No.	1188179
description	electronic controller TECNOLOGIC type Y39SE mounting measurements 71x29mm 100-240V voltage AC NTC/PTC relay outputs 3 NO-16A CO-10A NO-5A NTC/PTC NTC/PTC DI front measurements 78x35mm built-in depth 64mm protection IP65 yes yes defr. funct. yes -50 up to +150°C display 3 digits		

			
1			
No.	378458 ¹	Ref. No.	N/A
description	electronic controller TECNOLOGIC type Y39S-HRRRB-A-E mounting measurements 74x32mm 100-240V voltage AC NTC/PTC relay outputs 3 NO-16A(9) CO-8A(3) NO-5A(2) NTC/PTC NTC/PTC DI built-in depth 64mm yes defr. funct. yes -99 up to +150°C display 3½ digits		
accessories for	378458		
	No.	378261	Ref. No. —
	temperature probe NTC 10kOhm cable thermoplastic probe -40 up to +110°C cable -40 up to +110°C probe ø6x35mm cable length 3m without screw connection 2-wire		
	No.	379052	Ref. No. —
	temperature probe PTC 1kOhm cable silicone probe -50 up to +150°C cable -50 up to +180°C probe ø6x40mm cable length 1.5m without screw connection 2-wire		
	No.	379053	Ref. No. —
	temperature probe PTC 1kOhm cable PVC probe -50 up to +150°C cable -10 up to 100°C probe ø6x30mm cable length 3m without screw connection 2-wire		
	No.	379064	Ref. No. —
	temperature probe PTC 1kOhm cable silicone probe -50 up to +150°C cable -50 up to +180°C probe ø6x40mm cable length 3m without screw connection 2-wire		
	No.	379142	Ref. No. —
	temperature probe PTC 1kOhm cable PVC probe -50 up to +150°C cable -10 up to 100°C probe ø6x30mm cable length 1.5m without screw connection 2-wire		
	No.	379160	Ref. No. —
	temperature probe NTC 10kOhm cable thermoplastic probe -40 up to +110°C cable -40 up to +110°C probe ø6x14mm cable length 1.5m without screw connection 2-wire		
	No.	379161	Ref. No. —
	temperature probe NTC 10kOhm cable thermoplastic probe -40 up to +110°C cable -40 up to +110°C probe ø6x14mm cable length 3m without screw connection 2-wire		
	No.	379342	Ref. No. —
	temperature probe NTC 10kOhm cable PVC probe -20 up to +80°C cable -10 up to 100°C probe ø6x25mm cable length 1.5m 2-wire protection IP67		
	No.	379343	Ref. No. —
	temperature probe NTC 10kOhm cable silicone probe -40 up to +110°C cable -50 up to +180°C probe ø6x40mm cable length 3m 2-wire		
	No.	379458	Ref. No. —
	temperature probe NTC 10kOhm cable silicone probe -40 up to +110°C cable -50 up to +180°C probe ø6x40mm cable length 1.5m without screw connection 2-wire		

¹application by touchscreen

accessories for	378458		
	No.	379637	Ref. No. —
	temperature probe PTC 1kOhm cable PVC probe -50 up to +150°C cable -10 up to 100°C probe ø6x35mm cable length 2m without screw connection 2-wire		
	No.	379781	Ref. No. —
	temperature probe PTC 1kOhm cable thermoplastic probe -50 up to +150°C cable -40 up to +110°C probe ø6x14mm cable length 1.5m without screw connection 2-wire		
	No.	379782	Ref. No. —
	temperature probe PTC 1kOhm cable thermoplastic probe -50 up to +150°C cable -40 up to +110°C probe ø6x14mm cable length 3m 2-wire resistor 1kOhm		
	No.	379804	Ref. No. —
	protector for electronic controller 71x29 L 93mm W 65mm plexiglas		
	No.	379860	Ref. No. —
	temperature probe NTC 10kOhm cable PVC probe -20 up to +80°C cable -10 up to 100°C probe ø6x40mm cable length 1.5m without screw connection 2-wire		

compressors

ACC/ZEL

R134A

LBP monophase

Lower evaporation temperature below -20°C

			
1			
No.	605062	Ref. No.	4106006+1147033
description	compressor coolant R134a type GL80AA 220-240V 50Hz LBP fully hermetic 9kg 1/5HP cylinder capacity 7.39cm ³ RSIR H 175mm 102W 144W 196W 256W 326W test method ASHRAE ambient temperature max. 43°C		



R404a/R507

HMBP monophase

High/Medium evaporation temperature above -20/-15 °C



1

No.	605014	Ref. No.	4106053 4106053+1147263
description	compressor coolant R404a/R507 type ML80TB 220-240V 50Hz HMBP fully hermetic 11.4kg 3/8HP cylinder capacity 7.57cm ³ CSIR H 175.5mmW 261W 346W 446W 561W 691W 835W 993W 1167W test method ASHRAE ambient temperature max. 43°C		



1

No.	605028	Ref. No.	4106054 4106054+1147282
description	compressor coolant R404a/R507 type ML90TB 220-240V 50Hz HMBP fully hermetic 11.6kg 3/8HP cylinder capacity 8.85cm ³ CSIR H 175.5mmW 323W 418W 532W 666W 819W 990W 1181W 1391W test method ASHRAE ambient temperature max. 43°C		

CUBIGEL

R134A

LBP monophase

Lower evaporation temperature below -20°C



1

No.	605197	Ref. No.	4106004 4106004+1147031
description	compressor coolant R134a type GL60AA 220-240V 50Hz LBP 9.1kg 1/6HP power input 126W cylinder capacity 5.99cm ³ RSIR H 175mm 98W 135W 178W 227W 283W test method ASHRAE ambient temperature max. 43°C		



1

No.	605185	Ref. No.	4106017+1147210
description	compressor coolant R134a type GL90AA 220-240V 50Hz LBP 9.4kg 1/4HP power input 184W cylinder capacity 8.1cm ³ RSIR H 185.6mm 148W 200W 261W 330W 407W test method ASHRAE ambient temperature max. 43°C		



R404a/R507

LBP monophase

Lower evaporation temperature below -20°C



1

No.	605207	Ref. No.	4106033+1147260 4106051
description	compressor coolant R404a/R507 type ML80FB 220-240V 50Hz LBP 10.9kg 1/4HP cylinder capacity 8.1cm ³ CSIR H 185mm 276W 314W 356W 401W 450WWWWWW test method ASHRAE ambient temperature max. 43°C		

EMBRACO / ASPERA

R134A

LBP monophase

Lower evaporation temperature below -20°C



1

No.	605265	Ref. No.	4108050+1147500
description	compressor coolant R134a type NE2134Z 220-240V 50Hz LBP 11.65kg 1/2HP cylinder capacity 14.28cm ³ CSIR 261W 350W 458W 588W 741WWWWWW test method ASHRAE		



1

No.	605176	Ref. No.	4106034
description	compressor coolant R404a/R507 type ML90FB 220-240V 50Hz LBP 11kg 1/3HP cylinder capacity 8.85cm ³ CSIR H 198mm 305W 394W 495W 606W 729WWWWWW test method ASHRAE		

R404a/R507

LBP monophase

Lower evaporation temperature below -20°C



1

No.	605260	Ref. No.	4106112+1147424
description	compressor coolant R404A type NT2192GK 220/240V 50Hz LBP 17.5kg 1.1HP cylinder capacity 22.37cm ³ CSCR 815W 1066W 1361W 1701W 2085WWWWWW		

HMBP monophase

High/Medium evaporation temperature above -20/-15 °C



1

No.	605029	Ref. No.	4106070 4106113 4106113+1147428
description	compressor coolant R404a/R507 type MP12RB 220-240V 50Hz HMBP fully hermetic 13.5kg 1/2HP cylinder capacity 12cm ³ CSR H 203.6mmW 561W 734W 933W 1157W 1407W 1681W 1982WW test method ASHRAE ambient temperature max. 43°C		

HMBP monophase

High/Medium evaporation temperature above -20/-15 °C



1

No.	605125	Ref. No.	4108043
description	compressor coolant R404a/R507 type NEK6213GK 220-240V 50Hz HMBP 11.6kg 1/2HP cylinder capacity 12.12cm ³ CSIR H 206mmW 695W 884W 1093W 1333W 1600W 1894W 2215W test method ASHRAE		

SECOF DANFOSS

R404a/R507

LBP monophase

Lower evaporation temperature below -20°C



1

No.	605178	Ref. No.	4108045
description	compressor coolant R404a/R507 type NEK6217GK 220-240V 50Hz HMBP 11.6kg 5/8HP cylinder capacity 14.3cm ³ CSR H 206mmW 777W 954W 955W 1171W 1386W 1651W 1916W		



1

No.	605132	Ref. No.	4108069	
description	compressor coolant R404a/R507 type NT6222GK 200-240V 50Hz HMBP fully hermetic 17kg 1HP cylinder capacity 17.39cm ³ CSR H 252mmW 810W 1032W 1040W 1174W 1307W 1583W 2247W test method ASHRAE			
accessories for	605132			
	No.	365142	Ref. No.	—
	operating capacitor capacity 15µF 450V with metal case tolerance 5% 50/60Hz ø 40mm L 110mm M8x1.25			
	No.	365153	Ref. No.	—
	starting capacitor 52µF 330V 50/60Hz duty cycle 3s 41280A133 2252347 ø 36mm L 83mm M8 plastic connection cable 350mm			
	No.	390981	Ref. No.	—
	klixon suitable for NT6222GK			



1

No.	605057	Ref. No.	4109024 4109024+1147206	
description	compressor coolant R404a/R507 type SC12CL 220-240V 50Hz LBP fully hermetic 12.5kg 3/8HP cylinder capacity 12.87cm ³ CSIR H 209mm 410W 568W 754W 971W 1220W 1505W test method ASHRAE			
spare parts for	605057			
	No.	380078	Ref. No.	—
	start relay DANFOSS 117U6005 HST			



1

No.	605058	Ref. No.	4109054 4109054+1147324	
description	compressor coolant R404a/R507 type SC15CL 220-240V 50Hz LBP fully hermetic 13.8kg 1/2HP cylinder capacity 15.28cm ³ CSIR H 219mm 486W 637W 813W 1017W 1251W 1699W test method ASHRAE 175W 358W			
spare parts for	605058			
	No.	380058	Ref. No.	—
	start relay DANFOSS 117U6019/F278 HST			



No.	605056	Ref. No.	4109026+1147323
description	compressor coolant R404a/R507 type SC18CLX.2 220-240V 50Hz LBP fully hermetic 13.7kg 5/8HP cylinder capacity 17.69cm ³ CSR H 219mm 562W 691W 881W 1095W 1332W 1593W test method ASHRAE		
spare parts for	605056		
	No.	381548	Ref. No.
			—
	start relay DANFOSS		

fans

axial fans

import



No.	601510 ¹	Ref. No.	4021019
description	axial fan L 119mm W 119mm H 38mm 230VAC 50/60Hz 22/21W bearing ball bearing connection male faston 6.3mm SUNON temp.-resist. 70°C		

¹with ball bearings

evaporation and condensing trays

condensing trays heated

universal

heating cartridges



No.	417577	Ref. No.	1192081 (alternativ)
description	heating cartridge 190W 230V ø 12mm L 180mm thread 3/8" cable length 300mm suitable for MONDIAL		





No.	417571	Ref. No.	1192081
description	heating cartridge 230W 230V ø 12mm L 180mm thread 3/8" cable length 1000mm universal		

refrigeration fans

cold air circulating fans

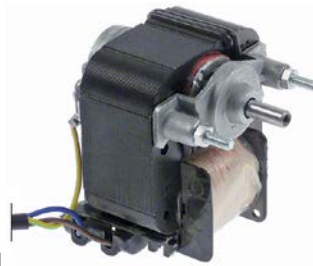
cold air circulating fans



No.	750398	Ref. No.	4121093
description	fan motor 230/240V 50/60Hz 35W shaft ø 6mm shaft L 14mm W 62mm H 73mm		
accessories for	750398		
	No.	601413	Ref. No.
			—
	fixing plate suitable for fanwheel ED ø 32mm shaft ø 7 mounting distance 26mm		
	No.	602184	Ref. No.
			—
	fixing plate suitable for fanwheel ED ø 33mm shaft ø 6 mounting distance 17mm		



cross flow fans

EMMEVI - FERGAS

with standard coil



1	No.	602070	Ref. No.	4022150
description	cross flow fan 116299 roller ø 60mm roller length 180mm laminated core thickness 20mm 220/240V - 50/60Hz 28W bearing rubber connection male faston 6.3mm			

with moulded coils



1	No.	601110	Ref. No.	4022142 4022149
description	cross flow fan TGO 60/1-180/20 roller ø 60mm roller length 180mm laminated core thickness 20mm motor position left 230V/50Hz 28W refrigeration bearing rubber connection male faston 6.3mm -30 up to +100°C 230V cable length 1800mm			
For models:	EBA01W540			

COPREL

with standard coil



1	No.	602044	Ref. No.	4022141 4022148
description	cross flow fan COPREL TFR 180/20-14CSN roller ø 60mm roller length 180mm laminated core thickness 20mm motor position right 230V/50Hz 27W refrigeration bearing rubber connection male faston 6.3mm t.max. 60°C airflow 144m³/h -30 bis +60°C			
For models:	EBA01W540			

equipment-specific units

for fridges

miscellaneous



1	No.	694849	Ref. No.	1721625
description	cover with sump for evaporator L 390mm W 355mm H 140mm plastic			

handles and hand wheels

bracket handles



1	No.	502270	Ref. No.	1721369
description	pull handle L 300mm H 50mm mounting distance 218mm hole ø 5mm grey			

accessories for	502270	No.	692567	Ref. No.	1721370
					cover L 295mm H 26mm ABS plastic





1	No.	502268	Ref. No.	1721349
description	pull handle L 300mm H 50mm mounting distance 218mm hole ø 5mm white			



1	No.	502269	Ref. No.	1721343
description	pull handle L 300mm H 50mm mounting distance 218mm hole ø 5mm white			



			
1			
No.	690451	Ref. No.	2121009
description	pull handle L 426mm H 40mm mounting distance 376mm black		

			
1			
No.	692571	Ref. No.	1721373
description	recessed handle L 250mm W 40mm H 20mm ABS plastic		

covers			
			
1			
No.	692566	Ref. No.	1721345
description	cover L 295mm H 26mm ABS plastic		



locks

locking devices

producer-specific

MONDIAL

			
1			
No.	692209	Ref. No.	5601058
description	key cylinder with slide latch ø 17mm thread M4 cam length 76mm cam width 13mm thread L 5.5mm		





			
1			
No.	692567	Ref. No.	1721370
description	cover L 295mm H 26mm ABS plastic		
accessories for	692567		
	No.	502270	Ref. No.
			1721369
			
	pull handle L 300mm H 50mm mounting distance 218mm hole ø 5mm grey		

shelves and shelf rails

grates

universal

without upstand

			
1			
No.	970126	Ref. No.	0621117
description	grate W 530mm D 650mm GN 2/1 plastic-coated steel wire gauge frame 8mm lengthwise wires gauge 5mm crossing wires 2 white suitable for refrigerator		
accessories for	970126		
	No.	690330	Ref. No.
			—
			
	rack L 1000mm W 22mm H 4mm aperture 3x8mm hole distance 12.5mm stainless steel		
	No.	694700	Ref. No.
			—
			
	shelf support L 31/28mm W 22mm H 18mm SS Qty 12 pcs		
	No.	694701	Ref. No.
			—
			
	shelf support L 31/28mm W 22mm H 17mm SS with hook Qty 12 pcs		

recessed handles

			
1			
No.	692568	Ref. No.	17210674
description	recessed handle L 120mm W 40mm H 22mm mounting distance 80mm ABS plastic		

			
1			
No.	692569	Ref. No.	1721039
description	recessed handle L 140mm W 30mm H 25mm mounting distance 80mm ABS plastic		

producer-specific

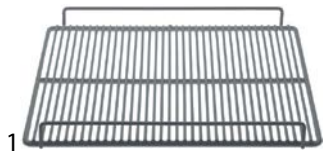

No.	970549	Ref. No.	0621130
description	grate W 448mm D 453mm steel with layer RILSAN white suitable for refrigerator with hinge camp		



No.	970491	Ref. No.	0621140
description	grate W 518mm D 408mm plastic-coated steel		

gaskets

refrigeration gaskets

plug-in gaskets

profile 9431

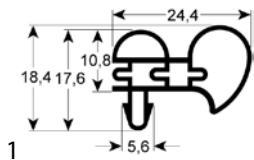

No.	902407	Ref. No.	N/A
description	refrigeration gasket profile 9431 Wmm L 2500mm		

profile 9050

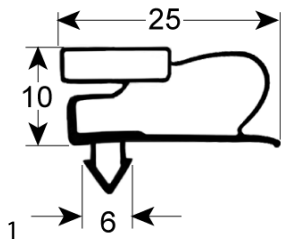

No.	901441	Ref. No.	4612003
description	refrigeration gasket profile 9050 W 518mm L 1627mm plug size L1 1640mm W1 531mm external size		

profile 9773

We offer custom-made gaskets for this profile

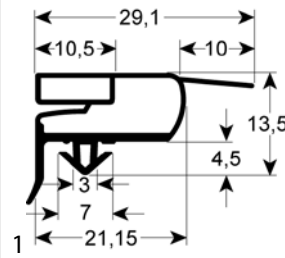

No.	901782	Ref. No.	4612040
description	refrigeration gasket profile 9773 W 520mm L 1640mm external size W1 507mm L1 1627mm plug size		

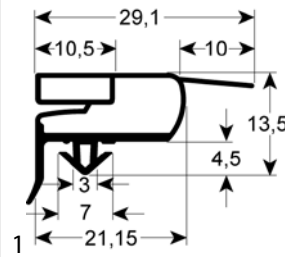

No.	901334	Ref. No.	4612135
description	refrigeration gasket profile 9773 W 558mm L 732mm plug size		

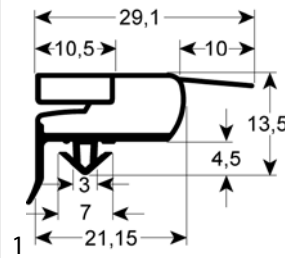

No.	901090	Ref. No.	4612084
description	refrigeration gasket profile 9773 W 566mm L 1455mm external size W1 553mm L1 1442mm plug size		

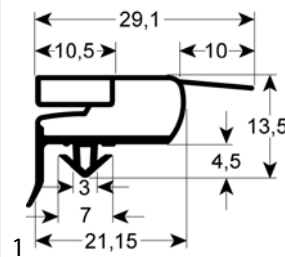

No.	901088	Ref. No.	4612082
description	refrigeration gasket profile 9773 W 566mm L 1705mm external size W1 553mm L1 1692mm plug size		



No.	901487	Ref. No.	4612091
description	refrigeration gasket profile 9773 W 635mm L 1530mm external size W1 622mm L1 1517mm plug size grey		

No.	901977	Ref. No.	4612039
description	refrigeration gasket profile 9773 W 736mm L 1540mm plug size suitable for MONDIAL		

No.	901781	Ref. No.	4612120
description	refrigeration gasket profile 9773 W 635mm L 1530mm external size W1 622mm L1 1517mm plug size white		

No.	901087	Ref. No.	4612083
description	refrigeration gasket profile 9773 W 740mm L 1700mm external size W1 727mm L1 1687mm plug size		

No.	901089	Ref. No.	4612038
description	refrigeration gasket profile 9773 W 640mm L 1540mm external size W1 627mm L1 1527mm plug size		

No.	902305	Ref. No.	N/A
description	refrigeration gasket profile 9773 Wmm L 2500mm		

No.	901783	Ref. No.	4612041
description	refrigeration gasket profile 9773 W 705mm L 1640mm external size W1 692mm L1 1627mm plug size		

profile 9151

We offer custom-made gaskets for this profile

No.	901098	Ref. No.	4612069
description	refrigeration gasket profile 9151 W 565mm L 1690mm plug size		

No.	901174	Ref. No.	4612138
description	refrigeration gasket profile 9151 W 572mm L 1709mm external size L1 1699mm W1 562mm plug size		

No.	902127	Ref. No.	4612156
description	refrigeration gasket profile 9151 W 632mm L 1525mm plug size grey		

No.	902114	Ref. No.	4612155
description	refrigeration gasket profile 9151 W 632mm L 1525mm white		

No.	901093	Ref. No.	4612005
description	refrigeration gasket profile 9151 W 720mm L 1655mm plug size L1 1645mm W1 710mm external size		

No.	901168	Ref. No.	4612139
description	refrigeration gasket profile 9151 W 737mm L 1699mm plug size		

No.	901092	Ref. No.	4612068
description	refrigeration gasket profile 9151 W 755mm L 1705mm plug size L1 1695mm W1 745mm external size		

No.	902265	Ref. No.	N/A
description	refrigeration gasket profile 9151 Wmm L 2500mm		

profile 9010

We offer custom-made gaskets for this profile

No.	900617	Ref. No.	TDE072290
description	refrigeration gasket profile 9010 W 515mm L 620mm plug size		

No.	902115	Ref. No.	4612154
description	refrigeration gasket profile 9010 W 643mm L 1407mm plug size		

No.	901091	Ref. No.	4512017
description	refrigeration gasket profile 9010 W 650mm L 1545mm plug size		

No.	902251	Ref. No.	N/A
description	refrigeration gasket profile 9010 Wmm L 2500mm		

profile 9373

We offer custom-made gaskets for this profile

No.	902163	Ref. No.	N/A
description	refrigeration gasket profile 9373 Wmm L 2500mm		



refrigeration cycle components

filter driers

miscellaneous



1

No.	750244	Ref. No.	3141035
description	dryer size 15g ø 19mm L 117mm connection 3,2/6,2mm		
For models:	EBA01W540		



1

No.	750619	Ref. No.	3141033
description	dryer size 30g ø 24mm L 140mm connection 2,6/6,5mm Qty 1 pcs		

evaporators

for fridges

producer-specific



1

No.	750354	Ref. No.	4133007
description	evaporator L 1000mm W 470mm Hmm suitable for BEV/KIC		

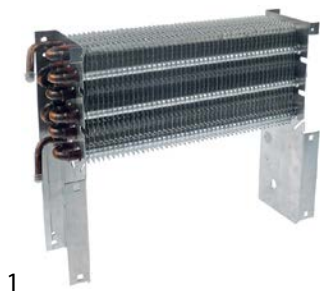

1

No.	750627	Ref. No.	4132069
description	evaporator L 335mm W 95mm H 275mm total length 355mm for fridge		

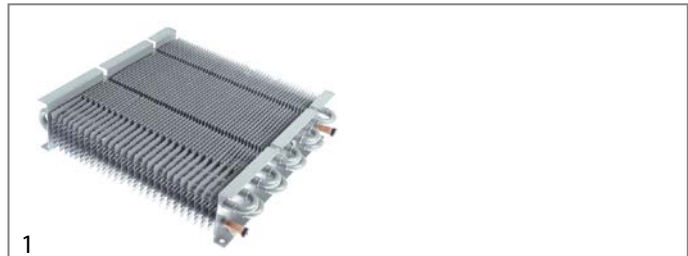

1

No.	750181	Ref. No.	TDE072247
description	evaporator L 360mm W 95mm H 350mm for Desmon refrigerated counter (PTR,LUX,TLM2A)		

measuring equipment

thermometers

built-in thermometers



1

No.	541081	Ref. No.	2531018
description	thermometer mounting measurements 58x25.5mm -40 up to +40°C capillary pipe 1500mm probe ø 8mm probe L 22mm		

battery powered



1

No.	379798	Ref. No.	1188017
description	thermometer mounting measurements 47x27mm battery comp. rear -40 up to +70°C cable length 2000mm white		

accessories for	379798			
	No.	379808	Ref. No.	—
	frame for thermometer internal size 47x27mm W 53mm H 33mm D 17mm lug length 11mm hole distance 64.2mm			