

Professionall

Solutii profesionale pentru echipamente profesionale



GAS COMPONENTS



ELECTRIC COMPONENTS



WATER TECHNOLOGY



MECHANICAL COMPONENTS



TOOLS

Spare parts suitable for

MIWE



heating elements

heating elements for ovens

			
No.	420349	Ref. No.	040504.01
description	heating element 4000W 400V heating circuits 1 L 573mm W 115mm thread M14x1.5 mounting distance 105mm tube ø 10mm connection cable cable length 2000mm dry heating element 2 hole fixing		

heating elements for pizza ovens

			
No.	420350	Ref. No.	071489.14
description	heating element 1500W 230V heating circuits 1 L 1295mm W 23mm connection cable connection distance 16.5mm tube ø 6.5mm cable length 740mm dry heating element		

coil heating elements

			
No.	420285	Ref. No.	060004.11
description	heating element 1000W 230V L 285mm W 70mm ø 24.5mm thread M14x1.5 connection M4 mounting distance 45mm connection length 41mm heating circuits 1		

			
No.	420286	Ref. No.	060004.00
description	heating element 1500W 230V L 285mm W 70mm ø 24.5mm thread M14x1.5 connection M4 mounting distance 45mm connection length 41mm heating circuits 1		

thermostats

control and safety thermostats

EGO

control thermostats

55.13_series

			
No.	375010	Ref. No.	504024.16
description	thermostat t.max. 250°C temperature range 50-250°C 1-pole 1NO 16A probe ø 3.1mm probe L 208mm capillary pipe 1130mm capillary pipe isolatedmm gland nut shaft L 23mm shaft position upper rotation 270°		

safety thermostats

55.32_series

			
No.	390836	Ref. No.	504024.30 504056.18
description	safety thermostat switch-off temp. 355°C 3-pole 3NC 20A probe ø 4mm probe L 120mm capillary pipe 1890mm capillary pipe isolated-mm gland nut probe		

JUMO

control thermostats

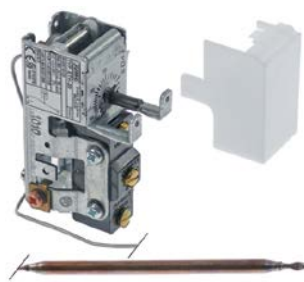
			
No.	390912 ¹	Ref. No.	504016.02
description	thermostat t.max. 500°C temperature range 20-500°C 1-pole 1CO 10A probe ø 6mm probe L 125mm capillary pipe 1500mm capillary pipe isolatedmm gland nut shaft ø 5mm shaft L 16mm 230V		

¹with accessories

safety thermostats

			
No.	376059	Ref. No.	504017.05
description	safety thermostat switch-off temp. adjustable 24-500°C temperature range 20-500°C 1-pole 1CO 10A probe ø 6mm probe L 130mm capillary pipe 2200mm capillary pipe isolatedmm gland nut with thermostat control		

1 electric components

No.	376060	Ref. No.	504048.02
description	safety thermostat temperature range 20-400°C 1-pole 1CO 10A probe ø 6mm probe L 180mm capillary pipe 2180mm capillary pipe isolatedmm gland nut thermostatically controlled outlet 2 probe		

control thermostats with actual value



No.	379844	Ref. No.	504056.01 504056.11
description	thermostat t.max. 320°C temperature range 0-320°C 1CO 10A probe ø 8mm probe L 265mm capillary pipe 1530mm		

switches and momentary switches

proximity switches



No.	348134	Ref. No.	504146.08
description	proximity switch 10-30VDC 0.1A ø 18mm D2 ø 12mm L 45mm IGS 206 induction		

lamps

screw-on/push-on fit

halogen lamp

for socket G4 / G6.35 / G9



No.	357192	Ref. No.	504588.13
description	halogen lamp socket G4 12V 20W temp.-resist.°C OSRAM HALOSTAR STARLITE		

for socket GU5.3 / GU10 / GZ5.3



No.	359496	Ref. No.	504587.07
description	halogen lamp socket GU5.3 12V 50W temp.-resist. 300°C		

oven lamps

lamps

halogen lamps

for socket G4 / G6.35 / G9



No.	357192	Ref. No.	504588.13
description	halogen lamp socket G4 12V 20W temp.-resist.°C OSRAM HALOSTAR STARLITE		

for socket GU5,3 / GU10



No.	359496	Ref. No.	504587.07
description	halogen lamp socket GU5.3 12V 50W temp.-resist. 300°C		

timers

audible timers



No.	360573	Ref. No.	505192.03
description	audible timer operation time 60min ø 56mm shaft ø 6x4.6mm shaft L 24mm mounting distance 28mm front measurements 72x72mm		



contactors

TELEMECANIQUE (Schneider Electric)

power contactors



1



No.	380965	Ref. No.	504202.07
description	power contactor resistive load 20A 230VAC (AC3/400V) 6A/2.2kW main contacts 3NO auxiliary contacts 1NO connection screw connection type LC1K0610P7+		

relays

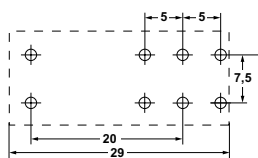
plug-in/print relays



1

No.	380335	Ref. No.	504296.00
description	print relay 230VAC 1CO at 250V 16A connection pins raster size 5mm Italiana Relè manuf. no. 40.61.8.230.0000 95.65/95.75		
accessories for	380335		
	No. 380340	Ref. No.	—
	relay socket dimensions 62x36x15mm 250V voltage AC 10A Italiana Relè manuf. no. ZMEM/5		
	No. 380505	Ref. No.	—
	relay socket 2CO 40.52 dimensions 81.9x15.5x75mm 250V voltage AC 10A FINDER manuf. no. 95.95.3		
	No. 381181	Ref. No.	—
	relay socket 2-pole 40.51/40.52/40.61 connection screw clamp dimensions 15.8x78.6mm 250V voltage AC 10A FINDER manuf. no. 95.75		

probes

universal probes

humidity probes



1

No.	403613	Ref. No.	504007.13
description	humidity probe humidity range 0-100% supply 3.6-30VDC outlet 4-20mA probe ø 12x120mmmm cable lengthm -40 up to +60°C connection coded plug		

producer-specific probes

probes



No.	378323	Ref. No.	504006.1 504006.55
description	temperature probe Pt1000 cable glass fibre probe -70 up to +500°C cable -50 up to +350°C connection 2-wire thread probe ø5x210mm cable length 2.2m		

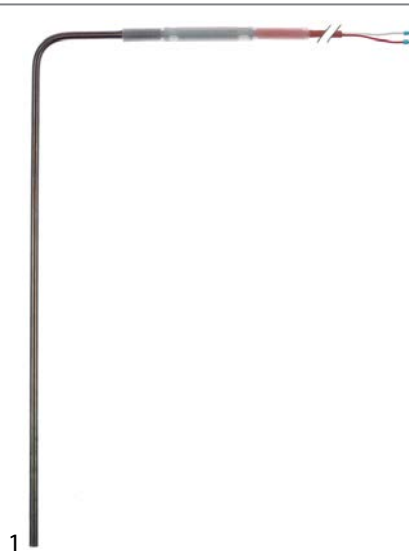

1

No.	378510	Ref. No.	504006.13
description	temperature probe Pt1000 cable silicone probe -50 up to +500°C cable -50 up to +180°C connection 2-wire probe ø5x290mm cable length 4.5m		

electronics

PCBs



1

No.	403269	Ref. No.	504078.90A 504078.91
description	PCB oven 3789,3909,13023,23842,26705 L 205mm W 167mm complete incl. fastening plate		

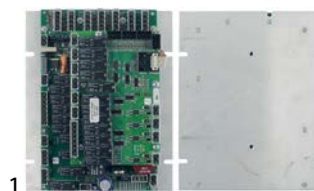

1

No.	403614	Ref. No.	504078.95 504078.95A 504078.96
description	power PCB oven MIWE L 203mm W 130mm 504078.95A		



solenoid valves

solenoid valves (water)

metal

solenoid valves (various)



1

No.	370713	Ref. No.	505212.11 505212.45
description	solenoid valve 2-ways 230VAC inlet 3/8" connection 3/8" L 44mm type series 8498082 50/60Hz brass		

flow meters and flow sensors

flow meters

DIGMESA



1

No.	403268	Ref. No.	507570.03
description	flow meter thread 1/4" brass male faston 2.8mm approval NSF reducer ø 2mm		

fans

cross flow fans

TRIAL



1

No.	601768	Ref. No.	506034.03 506034.07
description	cross flow fan TAL 90/397/N roller ø 90mm roller length 397mm motor position left 220V/50Hz 70W universal bearing silicone connection screw -40 up to +70°C 220V 50/60Hz		

hot air motors



1

No.	601853	Ref. No.	187282.00
description	fan wheel D1 ø 350mm H1 80mm blades 12 D2 ø 13.2mm D3 ø 16.2mm H2 32mm H3 3.5mm		

motors

gear motors

for ovens

for flues



1

No.	501509	Ref. No.	506605.34
description	actuator GRUNER type 225S-230T-02-004 1.5W 230V voltage AC/DC 50/60Hz shaft ø 16mm L 170mm W 66mm H 61mm load capacity 2NM		

electric accessories

cables

PVC cable



1

No.	551313	Ref. No.	504781.31
description	PVC cable 3-pole 0.75mm ² grey conductor copper insulation PVC t.max. 105°C		



1

No.	551323	Ref. No.	504781.32
description	PVC cable 5-pole 0.75mm ² grey conductor copper insulation PVC t.max. 105°C		



1

No.	551322	Ref. No.	504783.32
description	PVC cable 5-pole 2.5mm ² grey conductor copper insulation PVC t.max. 105°C		



1 

No.	551316	Ref. No.	504781.33
description	PVC cable 7-pole 0.75mm ² grey conductor copper insulation PVC t.max. 105°C		

silicone cable
up to 180°C

1 

No.	551314	Ref. No.	504781.21
description	silicone cable 3-pole 0.75mm ² insulation silicone red permanent temperature -60 up to +180°C conductor copper		

1 

No.	551312	Ref. No.	504782.21
description	silicone cable 3-pole 1.5mm ² insulation silicone red permanent temperature -60 up to +180°C t.max. 230°C conductor copper		

1 

No.	551315	Ref. No.	504781.22
description	silicone cable 5-pole 0.75mm ² insulation silicone red permanent temperature -60 up to +180°C conductor copper		

ribbon cables
group 10

1 

No.	698698	Ref. No.	9500396
description	ribbon cable 2-pole L 175mm raster size 2mm		

equipment-specific units
for convection ovens/combi-steamers

injection pipes

1 

No.	698673	Ref. No.	043148.60
description	injection pipe L 460mm H 69mm ID ø 10mm ED ø 21.7mm W 100mm hole distance 70mm		

spare parts and accessories

1 

No.	694620	Ref. No.	507171.00
description	silicon insert for glass plate		

for ovens

housing and bezels

1 

No.	698677	Ref. No.	141161.10
description	frame W 622mm L 1710mm stainless steel with rails & screws		

miscellaneous

1 

No.	698675	Ref. No.	050045.01
description	casing cover stainless steel L 510mm W 180mm H 145mm 3/4"		



1

No.	698674	Ref. No.	044651.30
description	drive shaft L 415mm W 300mm H 300mm ø 40mm		

for pizza ovens

miscellaneous



1

No.	850120	Ref. No.	506453.14
description	hot plate L 815mm W 613mm H 12mm delivery freight forwarding company only		

for cleaning and disinfection machines

nozzles



1

No.	698683	Ref. No.	8301611
description	nozzle ø 13mm ID ø 3.5mm aperture 3mm L 42mm 1/4"		

locks

electromagnetic closer



1

No.	692362	Ref. No.	088446.00 088446.01
description	electromagnetic closer 24V voltage DC L 104mm W 24mm H 29mm		

gaskets

gaskets for heated units

door seals



1

No.	902077	Ref. No.	046574.75
description	door seal profile 2433 W 1080mm L 1995mm external size		

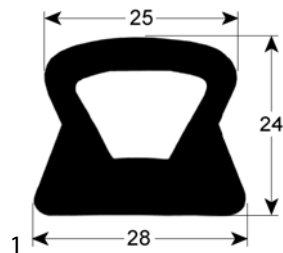

1

No.	901639	Ref. No.	046571.70 046574.70
description	door seal profile 2433 W 620mm L 1750mm external size 3-sided		

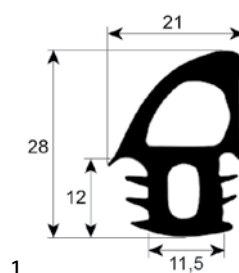

1

No.	901474	Ref. No.	188024.01 189016.01
description	door seal profile 2695 perimeter 2200mm		



1			
No.	901473	Ref. No.	189016.02 816823
description	door seal profile 2695 perimeter 2520mm		

1			
No.	901475	Ref. No.	189016.09
description	door seal profile 2695 perimeter 2670mm		

1			
No.	901476	Ref. No.	187719.02
description	door seal profile 2710 perimeter 1960mm Qty 1		

gaskets for tray rack trolleys

1			
No.	901666	Ref. No.	046569.20
description	tray rack trolley gasket profile 4200 L 558mm W 40mm thickness 13mm		