

Professionall

Solutii profesionale pentru echipamente profesionale



GAS COMPONENTS



ELECTRIC COMPONENTS



WATER TECHNOLOGY



MECHANICAL COMPONENTS



TOOLS

Spare parts suitable for

LUXIA



heating elements

immersion heating elements

3 hole flange ø47.5mm

No.	418793	Ref. No.	L2123 L2134
description	heating element 4300W 230/400V mounting ø 47.5mm heating circuits 3 L 270mm W 30mm H 32mm number of thermostat sleeves 1 thermostat sleeves ø 7mm length thermostat sleeves 230mm thermostat sleeve eccentric, non clinging tube ø 8mm connection M4		
For models:	K1000QBS, K660, OCEANO60, POLY1000, T50		

No.	418794	Ref. No.	L2135
description	heating element 6000W 230/400V mounting ø 47.5mm heating circuits 3 L 380mm W 33mm H 32mm number of thermostat sleeves 1 thermostat sleeves ø 7mm length thermostat sleeves 240mm thermostat sleeve eccentric, non clinging tube ø 8.5mm connection M4		
For models:	K1300, POLY1500		

No.	415028	Ref. No.	L7415	
description	heating element 9000W 230/400V mounting ø 47.5mm heating circuits 3 L 440mm W 33mm H 32mm number of thermostat sleeves 1 thermostat sleeves ø 7mm length thermostat sleeves 235mm thermostat sleeve upper tube ø 8.5mm hole distance 63mm hole ø 10mm connection M4 3 hole flange immersion heater			
For models:	POLY2000			
spare parts for	415028			
	No.	510408	Ref. No.	L5107
	O-ring EPDM thickness 5.34mm ID ø 47mm Qty 1 pcs			
accessories for	415028			
	No.	510408	Ref. No.	L5107
	O-ring EPDM thickness 5.34mm ID ø 47mm Qty 1 pcs			
	No.	510562	Ref. No.	—
	O-ring silicone thickness 5.34mm ID ø 47mm Qty 1 pcs			
	No.	521103	Ref. No.	—
	nut thread M4 H 3mm WS 7 brass Qty 20 pcs			
	No.	521104	Ref. No.	—
	washer ID ø 4.3mm ED ø 8mm thickness 0.5mm brass Qty 20 pcs for thread M4			

accessories for	415028			
	No.	560111	Ref. No.	—
	plain washer ID ø 4.3mm ED ø 9mm thickness 0.8mm SS Qty 20 pcs DIN 125A for thread M4			
	No.	560131	Ref. No.	—
	hexagonal nut thread M4 H 3.2mm WS 7 SS DIN/ISO DIN 934 / ISO 4032/8673 Qty 20 pcs			

No.	418709	Ref. No.	L2120 L2122 L2128	
description	heating element 2400W 230V mounting ø 47.5mm heating circuits 1 L 190mm W 32mm H 40mm number of thermostat sleeves 1 thermostat sleeves ø 7mm length thermostat sleeves 170mm thermostat sleeve eccentric, non clinging tube ø 6.5mm hole distance 72mm hole ø 8x10mm connection M4 3 hole flange immersion heater			
For models:	K10QT, K11QS, K12QS, K400QS, K502QBS, OCEANO35, OCEANO40, OCEANO50, T40, T45			
spare parts for	418709			
	No.	510408	Ref. No.	L5107
	O-ring EPDM thickness 5.34mm ID ø 47mm Qty 1 pcs			
accessories for	418709			
	No.	510562	Ref. No.	—
	O-ring silicone thickness 5.34mm ID ø 47mm Qty 1 pcs			

No.	416378	Ref. No.	L7212	
description	heating element 1000W 230V heating circuits 1 L 152mm W 35mm H 25mm H1 5mm H2 20mm thread M10x1 mounting distance 26mm tube ø 6.5mm			
For models:	OCEANO35, OCEANO40, OCEANO50, OCEANO60			
accessories for	416378			
	No.	510416	Ref. No.	—
	flat gasket fibre ED ø 19mm ID ø 10.5mm thickness 1.5mm for thread M10 Qty 1 pcs			
	No.	510893	Ref. No.	—
	O-ring EPDM thickness 2.62mm ID ø 9.92mm Qty 1 pcs			
	No.	520231	Ref. No.	—
	nut thread M10x1 H 6mm WS 14 zinc-coated steel Qty 1 pcs			
	No.	521129	Ref. No.	—
	nut thread M10 H 6mm SS WS 17 Qty 1 pcs DIN/ISO DIN 439			



			
No.	416379	Ref. No.	2127 L2127
description	heating element 2000W 230V L 265mm W 37mm H 40mm thread M10x1 mounting distance 30mm tube ø 6.5mm connection M4		
For models:	K1000QBS, K10QT, K11QS, K12QS, K1300, K400QS, K502QBS, K660, POLY1000, POLY1500, POLY2000		

foil heating elements

			
No.	416372	Ref. No.	L7011
description	foil heating element L 220mm W 110mm 450W 230V t.max.°C with thermostat 140°C silicone cable length 1000mm thickness 1mm		
For models:	T40, T45, T50		

accessories

sealing washers

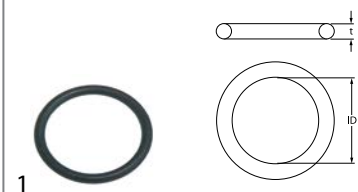

O-rings

			
No.	510408	Ref. No.	L5107
description	O-ring EPDM thickness 5.34mm ID ø 47mm Qty 1 pcs		
For models:	K1000QBS, K10QT, K11QS, K12QS, K1300, K400QS, K502QBS, K660, OCEANO35, OCEANO40, OCEANO50, OCEANO60, POLY1000, POLY1500, POLY2000, T40, T45, T50		

thermostats

bi-metal thermostats

safety bi-metal thermostats

			
No.	390233	Ref. No.	L2062 L7292
description	bi-metal safety thermostat hole distance 24mm switch-off temp. 110°C 1NC 1-pole 16A connection F6.3 2 hole fixing without holder		
For models:	K660, OCEANO35, OCEANO40, OCEANO50, OCEANO60, POLY1500, POLY2000		
accessories for	390233		
	No.	504736	Ref. No. —
bracket for contact thermostat			
	No.	550388	Ref. No. —
bracket for contact thermostat mounting distance 24.5mm mounting ø 3.8			

bi-metal thermostats

			
No.	390301	Ref. No.	L2061 L2083
description	bi-metal thermostat hole distance 23.8mm switch-off temp. 60°C 1NC 1-pole 16A connection F6.3 2 hole fixing		
For models:	K10QT, K12QS, OCEANO35, OCEANO40, OCEANO50, OCEANO60		

control and safety thermostats

IMIT / TEMPOMATIC / ARTHERMO

control thermostats

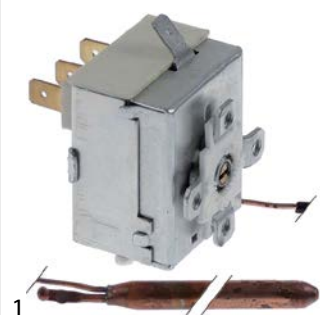
			
No.	376053	Ref. No.	L2060
description	thermostat t.max. 87°C temperature range 0-87°C 1-pole 1CO 16A probe ø 6.5mm probe L 97mm capillary pipe 1500mm capillary pipe isolated 1400mm gland nut shaft ømm shaft Lmm shaft position		
For models:	K1000QBS, K10QT, K11QS, K12QS, K1300, K400QS, K502QBS, K660, OCEANO35, OCEANO40, OCEANO50, OCEANO60, POLY1000, POLY1500, POLY2000, T40, T45, T50		

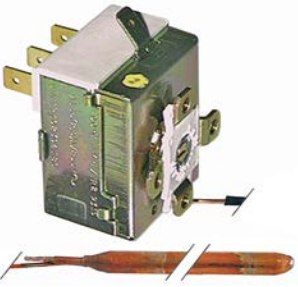
No.	390460	Ref. No.	2060
description	thermostat t.max. 90°C temperature range 30-90°C 1-pole 1CO 16A probe ø 6.5mm probe L 95mm capillary pipe 2000mm capillary pipe isolated 1950mm gland nut shaft ømm shaft Lmm shaft position rotation 270° probe material copper		

28.5x28.5mm



No.	345565	Ref. No.	L7440
description	push switch mounting measurements 28.5x28.5mm green 2NO 250V 16A connection male faston 6.3mm ambient temperature max. 150°C protection IP40		
For models:	POLY1500		

refrigeration thermostats

RANCO

K61 series



No.	390289	Ref. No.	FA1073 L4750 M06711020
description	thermostat RANCO type K61L1502 probe ømm probe Lmm capillary pipe 2150mm		

28.5x52.6mm



No.	346076	Ref. No.	L7210
description	switch combination mounting measurements 28.5x52.6mm black/grey 2NO/1NO 250V 16A ON-OFF, timer connection male faston 6.3mm ambient temperature max. 85°C protection IP40		
For models:	OCEANO35, OCEANO40, OCEANO50, OCEANO60, POLY1000, POLY1500		

switches and momentary switches

push/momentary push switches

19x13mm



No.	301105	Ref. No.	L7066
description	momentary push switch mounting measurements 19.3x12.9mm black 1NO 250V 16A connection male faston 6.3mm ambient temperature max. 150 85°C protection IP40		
For models:	POLY2000, T40, T45, T50		

28.5x77.5mm



No.	346551	Ref. No.	L2037
description	switch combination latching/momentary/latching mounting measurements 28.5x77.5mm green/grey/black 2NO/1NO/2NO 250V 16A time/main switch connection male faston 6.3mm ambient temperature max. 85°C protection IP40		
For models:	K1300		



No.	301106	Ref. No.	L7065
description	push switch mounting measurements 19x13mm black 2NO 230V 16A connection male faston 6.3mm ambient temperature max. 150 85°C protection IP40		
For models:	POLY2000, T40, T45, T50		



No.	346996	Ref. No.	L2034
description	switch combination momentary mounting measurements 28.5x77.5mm blue/grey/black 2NO/1NO/1NO 250V 16A with indicator main switch/time/rinsing connection male faston 6.3mm ambient temperature max. 55/120°C protection IP40		
For models:	K1000QBS, K10QT, K11QS, K12QS, K400QS, K502QBS, K660		



microswitches

lever actuated



1

No.	345742	Ref. No.	L7071
description	microswitch with lever 250V 16A 1CO connection male faston 6.3mm L 55mm ambient temperature max. 120°C mounting distance 22mm actuating force: 75g lever length 46mm		
For models:	T40, T45, T50		

pin-plunger actuated

miscellaneous



1

No.	346997	Ref. No.	2131 L2131
description	microswitch 250V 6A 1NO connection male faston 6.3mm ambient temperature max. 125°C		
For models:	K1000QBS, K10QT, K11QS, K12QS, K400QS, K502QBS, OCEANO35, OCEANO40, OCEANO50, OCEANO60		

position switches

BREMAS



1

No.	346080	Ref. No.	L2109
description	position switch with plunger 1NO/1NC		
For models:	K1300		

system switches (ROLD)



1

No.	346617	Ref. No.	L7392
description	indicator light lens size 11x15.8mm green		
For models:	POLY1000		

rotary switches

LOVATO



1

No.	346555	Ref. No.	L2028
description	rotary switch 3 1-2-3 sets of contacts 3 type GN128940U 690V 12A shaft ø 6x6mm shaft L 23.5mm shaft square connection screw		
For models:	K1300, POLY1500, POLY2000		

miscellaneous



1

No.	347689	Ref. No.	L2030 L7070
description	rotary switch sets of contacts 2 2 0-1 type CS20-00063 690V 25A shaft ø 5x5mm shaft L 22mm shaft square connection male faston 6.3mm		

magnetic switches

36x13mm

1

No.	345795	Ref. No.	L7363
description	magnetic switch L 36mm W 13mm 1NO 250V 0.04A connection male faston 6.3mm 10W		
For models:	POLY1000, POLY1500, POLY2000		

lamps

indicator lights

indicator lights 2-piece (lens and indicator lamp)

indicator lamps for socket type SA / SC / SD / SF / SR



1

No.	359982	Ref. No.	L7063
description	indicator lamp 230V clear connection male faston 6.3mm Qty 1 pcs		
For models:	T40, T45, T50		



			
1			
No.	359983	Ref. No.	L7064
description	indicator lamp 230V green connection male faston 6.3mm Qty 1 pcs		
For models:	T40, T45, T50		

indicator lights (complete)
 ø10mm
 with plug-in socket

			
1			
No.	359139	Ref. No.	L2041
description	indicator light ø 10mm green 230V connection male faston 6.3mm Qty 1 pcs		
For models:	K1000QBS, K10QT, K11QS, K12QS, K1300, K400QS, K502QBS, K660		

			
1			
No.	359138	Ref. No.	L2040
description	indicator light ø 10mm red 230V connection male faston 6.3mm Qty 1 pcs		
For models:	K1000QBS, K10QT, K11QS, K12QS, K1300, K400QS, K502QBS, K660		

19x13mm

			
1			
No.	359201	Ref. No.	L7393
description	indicator light mounting measurements 19x13mm 230V green connection male faston 6.3mm temp.-resist. 150°C		
For models:	POLY2000		

			
1			
No.	359200	Ref. No.	L7397
description	indicator light mounting measurements 19x13mm 230V red connection male faston 6.3mm		
For models:	POLY2000		



28.5x52.6mm



			
1			
No.	359111	Ref. No.	L7211
description	indicator light mounting measurements 28.5x52.6mm 230V green/red		
For models:	OCEANO35, OCEANO40, OCEANO50, OCEANO60, POLY1000, POLY1500		

timers

programme timers

			
1			
No.	360400	Ref. No.	L2010
description	timer BIGATTI engines 1 chambers 2 operation time 120s 230V shaft ø 6x4.6mm shaft L 20mm manif. no. D94 / LU003 motor type 82394544		

			
1			
No.	360411	Ref. No.	L2014
description	timer CDC 11803 engines 1 chambers 3 operation time 120s 230V shaft ømm shaft Lmm motor type M48R ATS		
For models:	K1000QBS, K10QT, K11QS, K12QS, K400QS, K502QBS, K660, OCEANO35, OCEANO40, OCEANO50, OCEANO60, POLY1000, T40, T45, T50		
spare parts for	360411		
	No.	360118	Ref. No. —
	motor CDC pinion ø 4.9mm teeth 10 230V voltage AC 50/60Hz turn direction right motor ø 47mm H 19.3mm motor type M48R ATS for timer cable length 260mm 1.9/2.5W		

			
1			
No.	360524	Ref. No.	4695 L4695 M06712020
description	timer CDC 11904 engines 1 chambers 4 operation time 12min 230V shaft ømm shaft Lmm manif. no. 11904F1 / BDR000.0000 motor type M48R ATS		
spare parts for	360524		
	No.	360118	Ref. No. —
	motor CDC pinion ø 4.9mm teeth 10 230V voltage AC 50/60Hz turn direction right motor ø 47mm H 19.3mm motor type M48R ATS for timer cable length 260mm 1.9/2.5W		



1

No.	360154	Ref. No.	N23248
description	timer FIBER P20 engines 1 chambers 4 operation time 15min 230V shaft ømm shaft Lmm manuf. no. P205J04J714 motor type M51B-J0R6400		
spare parts for	360154		
	No.	360673	Ref. No. —
	motor kit pinion ø 6.8mm teeth 15 230V voltage AC 50/60Hz turn direction clockwise motor ø 48mm H 18.5mm motor type UDS-40NE1RNZ165 cable length 150mm with holder		

contactors

LOVATO

power contactors





1

No.	380705	Ref. No.	L2113
description	power contactor resistive load 20A 230VAC (AC3/400V) 9A/4kW main contacts 3NO auxiliary contacts 1NO connection screw connection type 11BG0910A230		
For models:	K1000QBS, K1300, K660, OCEANO60, POLY1000, POLY1500, POLY2000, T50		
accessories for	380705		
	No.	380057	Ref. No. —
	auxiliary contact contacts 1NO/1NC AC1 10A for contactors BG series connection screw type BGX1011		



1

No.	380855	Ref. No.	L2111
description	power contactor resistive load 25A 230VAC (AC3/400V) 4.2kW main contacts 3NO auxiliary contacts 1NO		
For models:	K1300, POLY1500, POLY2000		
accessories for	380855		
	No.	380055	Ref. No. —
	RC circuit voltage AC/DC suitable for BF09-32 rated 240V		
	No.	380118	Ref. No. —
	auxiliary contact contacts 1NO/1NC AC1 10A for contactors BF series connection screw type G480/11		

overload switches



1

No.	380670	Ref. No.	L2081
description	overload switch setting range 3-5A for contactors BG (BG06-BG12) series connection screw		
For models:	K1300		

relays

power relays

with bracket mounting

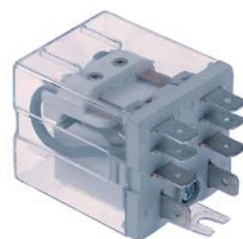

1

No.	380054	Ref. No.	L2082 L7391
description	power relays 230VAC 16A 2CO connection male faston 6.3mm bracket mounting		
For models:	K1300, POLY1000, POLY1500, POLY2000		

solenoïd valves

solenoïd valves (water)

RPE

















solenoïd valves with reducers





single



1

No.	370440	Ref. No.	N10368
description	solenoïd valve 1-fold, without membrane (constantly open) angled inlet 3/4" outlet 11.5mm input 10-12l/min RPE plastic flow regulating valve inlet white		

TP			
  1			
No.	370021	Ref. No.	L2020
description	solenoid valve double straight 230VAC inlet 3/4" outlet 11.5mm DN10 TP flow regulating valve inlet white		
For models:	K1000QBS, K100QT, K11QS, K12QS, K400QS, K502QBS		
spare parts for	370021		
	No.	371013	Ref. No. —
solenoid coil TP 230VAC 50/60Hz			
accessories for	370021		
	No.	371220	Ref. No. —
reducer TP flow rate 3l/min red tolerance ±15%			
	No.	371221	Ref. No. —
reducer TP flow rate 5.5l/min yellow tolerance ±15%			
	No.	371222	Ref. No. —
reducer TP flow rate 6l/min grey tolerance ±15%			
	No.	371223	Ref. No. —
reducer TP flow rate 10l/min white tolerance ±15%			
	No.	371224	Ref. No. —
reducer TP flow rate 12l/min bronze tolerance ±15%			
	No.	371225	Ref. No. —
reducer TP flow rate 16l/min light brown tolerance ±15%			
	No.	371226	Ref. No. —
reducer TP flow rate 20l/min red tolerance ±15%			
	No.	371230	Ref. No. —
reducer TP flow rate 0.25l/min red tolerance ±25%			
	No.	371231	Ref. No. —
reducer TP flow rate 0.35l/min violet tolerance ±25%			
	No.	371232	Ref. No. —
reducer TP flow rate 0.5l/min orange tolerance ±25%			
	No.	371233	Ref. No. —
reducer TP flow rate 0.8l/min white tolerance ±25%			
	No.	371234	Ref. No. —
reducer TP flow rate 1l/min light blue tolerance ±25%			
	No.	371235	Ref. No. —
reducer TP flow rate 1.2l/min brown tolerance ±25%			
	No.	371236	Ref. No. —
reducer TP flow rate 1.5l/min light brown tolerance ±25%			

accessories for 370021			
	No.	371237	Ref. No. —
reducer TP flow rate 2.5l/min yellow tolerance ±25%			
	No.	371238	Ref. No. —
reducer TP flow rate 3.4l/min dark green tolerance ±25%			
	No.	371239	Ref. No. —
reducer TP flow rate 5l/min black tolerance ±25%			
	No.	371240	Ref. No. —
reducer TP flow rate 8l/min blue tolerance ±20%			

TP			
  1			
No.	370017	Ref. No.	L2021
description	solenoid valve single straight 230VAC inlet 3/4" outlet 11.5mm DN10 TP p max 10bar		
For models:	K1300, K660, OCEANO35, OCEANO40, OCEANO50, OCEANO60, POLY1000, POLY1500, POLY2000, T40, T45, T50		
spare parts for	370017		
	No.	371013	Ref. No. —
solenoid coil TP 230VAC 50/60Hz			
accessories for	370017		
	No.	371220	Ref. No. —
reducer TP flow rate 3l/min red tolerance ±15%			
	No.	371221	Ref. No. —
reducer TP flow rate 5.5l/min yellow tolerance ±15%			
	No.	371222	Ref. No. —
reducer TP flow rate 6l/min grey tolerance ±15%			
	No.	371223	Ref. No. —
reducer TP flow rate 10l/min white tolerance ±15%			
	No.	371224	Ref. No. —
reducer TP flow rate 12l/min bronze tolerance ±15%			
	No.	371225	Ref. No. —
reducer TP flow rate 16l/min light brown tolerance ±15%			
	No.	371226	Ref. No. —
reducer TP flow rate 20l/min red tolerance ±15%			
	No.	371230	Ref. No. —
reducer TP flow rate 0.25l/min red tolerance ±25%			
	No.	371231	Ref. No. —
reducer TP flow rate 0.35l/min violet tolerance ±25%			
	No.	371232	Ref. No. —
reducer TP flow rate 0.5l/min orange tolerance ±25%			

accessories for		370017		
	No.	371233	Ref. No.	—
reducer TP flow rate 0.8l/min white tolerance ±25%				
	No.	371234	Ref. No.	—
reducer TP flow rate 1l/min light blue tolerance ±25%				
	No.	371235	Ref. No.	—
reducer TP flow rate 1.2l/min brown tolerance ±25%				
	No.	371236	Ref. No.	—
reducer TP flow rate 1.5l/min light brown tolerance ±25%				
	No.	371237	Ref. No.	—
reducer TP flow rate 2.5l/min yellow tolerance ±25%				
	No.	371238	Ref. No.	—
reducer TP flow rate 3.4l/min dark green tolerance ±25%				
	No.	371239	Ref. No.	—
reducer TP flow rate 5l/min black tolerance ±25%				
	No.	371240	Ref. No.	—
reducer TP flow rate 8l/min blue tolerance ±20%				

solenoid valves with reducers

	1		
No.	370427	Ref. No.	L4690
description	solenoid valve single angled 230VAC inlet 3/4" outlet 11.5mm input/min output 1.2l/min DN10 t.max. 90°C TP plastic flow regulating valve outlet dark brown		

pressure switches

for warewashing

ø 58mm with male faston 6.3mm

with connection horizontal

	1		
No.	541539	Ref. No.	L7375 L7433
description	pressure control pressure range 160/50mbar connection male faston 6.3mm ø 58mm pressure connection horizontal warewashing pressure connection ø 5mm		
For models:	POLY1000, POLY1500, POLY2000		

	1		
No.	541010	Ref. No.	2091 L2091 L7106
description	pressure control pressure range 50/30mbar connection 6mm ø 58mm pressure connection horizontal warewashing		
For models:	K10QT, K11QS, K12QS, K660, T40, T45		

	1		
No.	541141	Ref. No.	L7109
description	pressure control pressure range 75/35mbar connection 6mm ø 58mm pressure connection horizontal warewashing pressure connection ø 6mm		
For models:	OCEANO50, OCEANO60, T50		

	1		
No.	541311	Ref. No.	L2092
description	pressure control pressure range 76/38mbar connection 6mm ø 58mm pressure connection horizontal warewashing pressure connection ø 6mm		
For models:	K1000QBS, K1300, K400QS, K502QBS		

	1		
No.	541577	Ref. No.	L7249
description	pressure control pressure range 83/33mbar connection 6mm ø 58mm pressure connection horizontal pressure connection ø 6mm		
For models:	OCEANO35, OCEANO40		









pumps

wash and rinse pumps

ALBA (C&A)

pumps

			
1			
No.	500296	Ref. No.	L1301
description	pump inlet ø 28mm outlet ø 28mm type C903 230V 50Hz 1 phase 0.11kW 0.15HP L 200mm rotation direction left capacitor 6.3µF auxiliary pressure connection 13mm supporting pressure closed ALBA PUMPS (C&A)		
For models:	K10QT		
spare parts for	500296		
	No.	365012	Ref. No. —
	operating capacitor capacity 6.3µF 450V tolerance 5% 50Hz ambient temperature max. -25 to +85°C ø 30mm L 61mm M8 plastic connection male faston 6.3mm protection		
	No.	510692	Ref. No. —
	mechanical shaft seal for shaft ø 11mm slide ring ext. ø 24mm slide ring H 13mm counter ring mounting ø 26mm height counter ring 8mm counter ring int. ø 14mm		
	No.	521226	Ref. No. —
	impellor ø 72mm H 19mm thread M7R shaft ø 11mm shaft length 29mm blades 3		
	No.	521521	Ref. No. —
	pump cover ALBA PUMPS (C&A) inlet ø 28mm outlet ø 28mm auxiliary pressure connection 13mm supporting pressure closed turn direction left ø 93mm ID ø 76mm inner height 31mm		
	No.	532490	Ref. No. —
	O-ring EPDM thickness 2.62mm ID ø 72.69mm Qty 1 pcs		





			
1			
No.	499191	Ref. No.	L7180 L7181 L7450 L7483
description	pump inlet ø 28mm outlet ø 28mm type CL.1301 230V 50Hz 1 phase 0.11kW 0.15HP L 190mm rotation direction left capacitor 6.3µF ALBA PUMPS (C&A)		
For models:	OCEANO35, OCEANO40		
spare parts for	499191		
	No.	365012	Ref. No. —
	operating capacitor capacity 6.3µF 450V tolerance 5% 50Hz ambient temperature max. -25 to +85°C ø 30mm L 61mm M8 plastic connection male faston 6.3mm protection		
	No.	510692	Ref. No. —
	mechanical shaft seal for shaft ø 11mm slide ring ext. ø 24mm slide ring H 13mm counter ring mounting ø 26mm height counter ring 8mm counter ring int. ø 14mm		
	No.	521226	Ref. No. —
	impellor ø 72mm H 19mm thread M7R shaft ø 11mm shaft length 29mm blades 3		
	No.	521521	Ref. No. —
	pump cover ALBA PUMPS (C&A) inlet ø 28mm outlet ø 28mm auxiliary pressure connection 13mm supporting pressure closed turn direction left ø 93mm ID ø 76mm inner height 31mm		
	No.	532490	Ref. No. —
	O-ring EPDM thickness 2.62mm ID ø 72.69mm Qty 1 pcs		







1			
No.	500945	Ref. No.	L1321
description	pump inlet \varnothing 45mm outlet \varnothing 40mm 230V 1 phase 0.3kW 0.4HP L 175mm rotation direction right capacitor 10 μ F ALBA PUMPS (C&A)		
For models:	K12QS		
spare parts for	500945		
	No.	365015	Ref. No. —
	operating capacitor capacity 10 μ F 400V tolerance 5%Hz ambient temperature max. -25 to +85°C \varnothing 35.5mm L 59mm M8 plastic connection male faston 6.3mm protection		
	No.	509018	Ref. No. —
	O-ring EPDM thickness 3.53mm ID \varnothing 107.5mm Qty 1 pcs		
	No.	509028	Ref. No. —
	impellor \varnothing 87mm H 21mm rotation direction right thread M7L shaft \varnothing 12mm		
	No.	510693	Ref. No. —
	mechanical shaft seal for shaft \varnothing 12mm slide ring ext. \varnothing 24mm slide ring H 15.5mm slide ring int. \varnothing 11mm counter ring mounting \varnothing 24mm height counter ring 8mm counter ring int. \varnothing 13.5mm		
	No.	521528	Ref. No. —
	pump cover ALBA PUMPS (C&A) inlet \varnothing 45mm outlet \varnothing 40mm turn direction right \varnothing 129mm ID \varnothing 105mm inner height 19mm		







1			
No.	500085	Ref. No.	L1304 L1305
description	pump inlet \varnothing 45mm outlet \varnothing 40mm type C1001 230V 50Hz 1 phase 0.55kW 0.75HP L 200mm rotation direction right capacitor 16 μ F ALBA PUMPS (C&A)		
For models:	K502QBS		
spare parts for	500085		
	No.	365014	Ref. No. —
	operating capacitor capacity 12.5 μ F 450V tolerance 5%Hz ambient temperature max. -25 to +85°C \varnothing 35mm L 70mm M8 plastic connection male faston 6.3mm 45S.C3DS.12.5 protection		

spare parts for	500085		
	No.	509021	Ref. No. —
	impellor \varnothing 102mm H 32mm shaft intake \varnothing 9/8mm rotation direction right		
	No.	510693	Ref. No. —
	mechanical shaft seal for shaft \varnothing 12mm slide ring ext. \varnothing 24mm slide ring H 15.5mm slide ring int. \varnothing 11mm counter ring mounting \varnothing 24mm height counter ring 8mm counter ring int. \varnothing 13.5mm		
	No.	521531	Ref. No. —
	pump cover ALBA PUMPS (C&A) inlet \varnothing 45mm outlet \varnothing 40mm turn direction right \varnothing 153mm ID \varnothing 127mm inner height 24mm		
	No.	521709	Ref. No. —
	O-ring EPDM thickness 3mm ID \varnothing 126mm Qty 1 pcs		





1			
No.	500482	Ref. No.	L7072
description	pump inlet \varnothing 45mm outlet \varnothing 40mm type C7675 230V 50Hz 1 phase 0.29kW 0.4HP L 210mm rotation direction right capacitor 10 μ F ALBA PUMPS (C&A)		
For models:	T40, T45		
spare parts for	500482		
	No.	365015	Ref. No. —
	operating capacitor capacity 10 μ F 400V tolerance 5%Hz ambient temperature max. -25 to +85°C \varnothing 35.5mm L 59mm M8 plastic connection male faston 6.3mm protection		
	No.	509018	Ref. No. —
	O-ring EPDM thickness 3.53mm ID \varnothing 107.5mm Qty 1 pcs		
	No.	509028	Ref. No. —
	impellor \varnothing 87mm H 21mm rotation direction right thread M7L shaft \varnothing 12mm		
	No.	510693	Ref. No. —
	mechanical shaft seal for shaft \varnothing 12mm slide ring ext. \varnothing 24mm slide ring H 15.5mm slide ring int. \varnothing 11mm counter ring mounting \varnothing 24mm height counter ring 8mm counter ring int. \varnothing 13.5mm		



No.	501429	Ref. No.	L7362
description	pump inlet ø 63mm outlet ø 48mm type C.POLY2000 230/400V 50Hz 3 phase 0.9kW 1.2HP L 300mm rotation direction right ALBA PUMPS (C&A)		
For models:	POLY2000		
spare parts for	501429		
	No.	510551	Ref. No. —
	pump cover gasket ID ø 158.3mm pump type 1214/1293/1225/2243/1226/1204/3473/1241 thickness 3.53mm EPDM Qty 1 pcs		
	No.	510620	Ref. No. —
	impellor ø 109mm H 27mm rotation direction right thread M8L blades 6		
	No.	510693	Ref. No. —
	mechanical shaft seal for shaft ø 12mm slide ring ext. ø 24mm slide ring H 15.5mm slide ring int. ø 11mm counter ring mounting ø 24mm height counter ring 8mm counter ring int. ø 13.5mm		
	No.	521236	Ref. No. —
	impellor ø 105mm H 32mm M8R		





FIR pumps



No.	500457	Ref. No.	L7383
description	pump inlet ø 28mm outlet ø 26mm type 2213.1417 230V 50Hz 1 phase 0.15kW 0.2HP L 198mm rotation direction left capacitor 6.3µF FIR		
For models:	OCEANO50, OCEANO60		
spare parts for	500457		
	No.	365012	Ref. No. —
	operating capacitor capacity 6.3µF 450V tolerance 5% 50Hz ambient temperature max. -25 to +85°C ø 30mm L 61mm M8 plastic connection male faston 6.3mm protection		
	No.	510384	Ref. No. —
	pump cover inlet ø 28mm outlet ø 26mm ø 100mm ID ø 76mm		
	No.	510695	Ref. No. —
	mechanical shaft seal height counter ring 5.5mm ID ø 11mm		
	No.	521703	Ref. No. —
	pump cover gasket EPDM thickness 2.5mm ID ø 75mm Qty 1 pcs		





LGB



No.	500946	Ref. No.	L1303 L7501
description	pump inlet ø 45mm outlet ø 40mm type ZF150SX 230V 50Hz 1 phase 0.36kW 0.5HP L 180mm rotation direction right capacitor 10µF LGB		
For models:	K11QS, K400QS		
spare parts for	500946		
	No.	365015	Ref. No. —
	operating capacitor capacity 10µF 400V tolerance 5%Hz ambient temperature max. -25 to +85°C ø 35.5mm L 59mm M8 plastic connection male faston 6.3mm protection		
	No.	510703	Ref. No. —
	mechanical shaft seal for shaft ø 13mm slide ring H 13mm height counter ring 5.5mm ED ø 26mm		
	No.	521140	Ref. No. —
	pump cover LGB inlet ø 45mm outlet ø 40mm auxiliary pressure connection 12mm pump type ZF150SX		
	No.	521701	Ref. No. —
	pump cover gasket		



No.	500943	Ref. No.	L7455
description	pump inlet ø 62mm outlet ø 50mm type ZF522VSX 230V 50Hz 1 phase 0.7kW 0.95HP L 250mm rotation direction right capacitor 16µF LGB		
spare parts for	500943		
	No.	365021	Ref. No. —
	operating capacitor capacity 16µF 425V tolerance 5% 50/60Hz ambient temperature max. -25 to +85°C ø 35mm L 73mm single M8 plastic connection male faston 6.3mm 416.10.99 protection		

spare parts for	500943		
	No.	510551	Ref. No. —
	pump cover gasket ID ø 158.3mm pump type 1214/1293/1225/2243/1226/1204/3473/1241 thickness 3.53mm EPDM Qty 1 pcs		
	No.	510694	Ref. No. —
	mechanical shaft seal for shaft ø 13mm height counter ring 8mm ID ø 11.5mm H 16mm mounting ø 24/26mm int. ø 1 14mm		
	No.	521239	Ref. No. —
	impeller ø 110mm H 26mm rotation direction right thread M8L shaft ø 19.5mm shaft length 17mm seat ø 8.2mm blades 6		
	No.	521536	Ref. No. —
	pump cover ALBA / LGB inlet ø 62mm outlet ø 50mm auxiliary pressure connection 12mm supporting pressure closed turn direction right ø 180mm ID ø 150mm inner height 38mm		

condensators & interference suppression filters

filters

RC circuits

	No.	365211	Ref. No.	NC23457
description	interference suppression filter type XRY RC MKPX2 275V connection plug			

equipment-specific units for ice-cube maker

ice chutes

slide grates

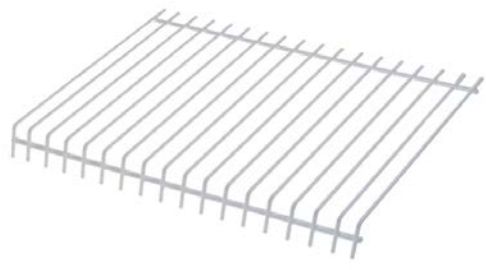
	No.	694281	Ref. No.	ND12001
description	slide grate for ice-cube maker L 325mm W 210mm			



curtains

with holder



1

No.	695506	Ref. No.	NC22034
description	curtain for ice maker W 328mm H 150mm with holder shaft length 325mm shaft ø 7.5mm		



1

No.	696594	Ref. No.	NC22106
description	curtain for ice-cube maker W 273mm H 160mm shaft length 280mm shaft ø 7.6mm holder length 316mm		

without holder



1

No.	695116	Ref. No.	NC10533
description	curtain for ice-cube maker W 320mm H 80mm shaft length 325mm shaft ø 7.5mm		

for coffee grinders



1

No.	345742	Ref. No.	L7071
description	microswitch with lever 250V 16A 1CO connection male faston 6.3mm L 55mm ambient temperature max. 120°C mounting distance 22mm actuating force: 75g lever length 46mm		
For models:	T40, T45, T50		

for dishwashers

drain and intake components

LUXIA

drain /intake bodies



1

No.	507478	Ref. No.	L3042
description	drain fitting thread 1" ED ø 50mm ID ø 25/21mm hose ø 26mm		
For models:	K10QT, K11QS, K12QS, OCEANO50, OCEANO60		



1

No.	507481	Ref. No.	L3043
description	drain fitting thread 1¼" ED ø 55mm ID ø 34/30mm hose ø 37mm		
For models:	K1000QBS, K1300, K400QS, K502QBS, K660, POLY1000, POLY1500, POLY2000		



1

No.	507479	Ref. No.	L5113
description	flat gasket rubber ED ø 55mm ID ø 42mm thickness 1mm Qty 1 pcs		
For models:	K1000QBS, K1300, K400QS, K502QBS, K660, POLY1000, POLY1500, POLY2000		



1



No.	519559	Ref. No.	L7006
description	intake/drain body ED ø 110mm ID ø 85mm outlet ø 45 outlet 2 ø 26		
For models:	T40, T45		
accessories for	519559		





No.	512402	Ref. No.	L7099
description	gasket rubber ED ø 105mm ID ø 85mm thickness 3mm Qty 1 pcs		



No.	519558	Ref. No.	L7007
description	locknut ED ø 105mm H 19mm ID ø 76mm		

			
1			
No.	519558	Ref. No.	L7007
description	locknut ED ø 105mm H 19mm ID ø 76mm		
For models:	T40, T45, T50		
accessories for	519558		
	No.	512402	Ref. No. L7099
	gasket rubber ED ø 105mm ID ø 85mm thickness 3mm Qty 1 pcs		
	No.	519559	Ref. No. L7006
	intake/drain body ED ø 110mm ID ø 85mm outlet ø 45 outlet 2 ø 26		

			
1			
No.	507477	Ref. No.	L3311
description	nut thread 1" ø 50mm H 7.5mm WS 36 brass Qty 1 pcs		
For models:	K10QT, K11QS, K12QS		

			
1			
No.	507480	Ref. No.	L3314
description	nut thread 1 1/4" ø 58mm H 8mm WS 44 brass Qty 1 pcs		
For models:	K1000QBS, K1300, K400QS, K502QBS, K660, POLY1000, POLY1500, POLY2000		

filters

			
1			
No.	507363	Ref. No.	3011 L3011
description	round filters ø 110mm H 65mm suction		
For models:	K10QT, K11QS, K12QS, K400QS, K502QBS		

			
1			
No.	507364	Ref. No.	L3016
description	round filters ø 140mm H 130mm suction		
For models:	K1300		

			
1			
No.	507365	Ref. No.	L3012
description	round filters ø 143mm H 80mm suction		
For models:	K1000QBS, K660		

			
1			
No.	507366	Ref. No.	L3030
description	screw connection for filter		
For models:	K1000QBS, K10QT, K11QS, K12QS, K1300, K400QS, K502QBS, K660		

overflow pipes

			
1			
No.	507484	Ref. No.	L3053 L3054
description	overflow pipe L 131mm ø 35mm		
For models:	K1000QBS, K400QS, K502QBS, K660		

			
1			
No.	507437	Ref. No.	L7980
description	overflow pipe L 180mm ø 35mm plastic		



			
1			
No.	507483	Ref. No.	L7105 L7299
description	overflow pipe L 230mm ø 25mm stainless steel		
For models:	T40, T45		



			
1			
No.	507429	Ref. No.	L3055
description	overflow pipe L 250mm ø 35mm		
For models:	K1300		

			
1			
No.	507482	Ref. No.	L3050
description	overflow pipe L 90mm ø 26mm plastic		
For models:	K10QT, K11QS, K12QS		

air traps

air traps

			
1			
No.	511447	Ref. No.	L3072
description	air trap with gasket L 84mm W 34mm H 50mm thread 3/4" hose ø 6mm		
For models:	K1000QBS, K10QT, K11QS, K12QS, K1300, K400QS, K502QBS, K660		

			
1			
No.	507489	Ref. No.	L7114
description	air trap without gasket L 84mm W 34mm H 50mm thread 3/4" hose ø 6mm		
For models:	OCEANO35, OCEANO40, OCEANO50, OCEANO60, POLY1000, POLY1500, POLY2000, T40, T45, T50		
accessories for	507489		
	No.	502036	Ref. No. —
	O-ring EPDM thickness 2.62mm ID ø 28.25mm Qty 1 pcs		
	No.	510154	Ref. No. L7045 L7100
	flat gasket rubber ED ø 33mm ID ø 26mm thickness 2mm Qty 1 pcs		

door mechanics

locks

			
1			
No.	507011	Ref. No.	L3110
description	door catch complete door locking catch		
For models:	K1000QBS, K10QT, K11QS, K12QS, K400QS, K502QBS, OCEANO35, OCEANO40, OCEANO50, OCEANO60		

washing and rinsing systems

			
1			
No.	507435	Ref. No.	L3360 L7083
description	bush for wash arm ø 16mm		
For models:	K1000QBS, K10QT, K11QS, K12QS, K1300, K400QS, K502QBS, K660, OCEANO35, OCEANO40, OCEANO50, OCEANO60, POLY1000, POLY1500, POLY2000, T40, T45, T50		

			
1			
No.	507427	Ref. No.	L3361
description	bush for wash arm ø 25mm		
For models:	K1300		

			
1			
No.	507434	Ref. No.	L3382
description	knurled nut thread M17x1 ø 30mm H 5mm SS		
For models:	K1300		

washing and rinsing systems (sorted by producer)

LUXIA



1

No.	507431	Ref. No.	L5041
description	wash arm L 215mm nozzles 6 number B		
For models:	K1000QBS, K1300, K660		



1

No.	507430	Ref. No.	L5040
description	wash arm L 215mm nozzles 7 number A		
For models:	K1000QBS, K1300, K660		



1

No.	507426	Ref. No.	L3378 L5032
description	wash arm boss		
For models:	K1300		



1

No.	507472	Ref. No.	L5109	
description	rinse arm L 155mm nozzles 2 type B			
For models:	K10QT, K11QS, OCEANO35			
spare parts for	507472			
	No.	507474	Ref. No.	L5030
	wash arm boss ø 12mm L 80mm W 78mm H 54mm			



1

No.	507470	Ref. No.	L5051
description	wash arm L 140mm nozzles 4 ø 25mm type A		
For models:	K10QT, K11QS		



1

No.	507469	Ref. No.	L5052
description	wash arm L 140mm nozzles 5 ø 25mm type B		
For models:	K10QT, K11QS		



1

No.	507474	Ref. No.	L5030
description	wash arm boss ø 12mm L 80mm W 78mm H 54mm		
For models:	K1000QBS, K10QT, K11QS, K12QS, K400QS, K502QBS, K660		



1

No.	507473	Ref. No.	L5112
description	rinse arm L 325mm nozzles 5 mounting ø 12mm mounting pos. upper		
For models:	K10QT, OCEANO35, OCEANO40		





1

No.	507472	Ref. No.	L5109	
description	rinse arm L 155mm nozzles 2 type B			
For models:	K10QT, K11QS, OCEANO35			
spare parts for	507472			
	No.	507474	Ref. No.	L5030
	wash arm boss ø 12mm L 80mm W 78mm H 54mm			





			
1			
No.	503166	Ref. No.	L7112
description	wash arm mounting pos. lower L 480mm nozzles 6		
For models:	T50		

miscellaneous			
			
1			
No.	507432	Ref. No.	L2161
description	end cap for rinse arm ø 10mm		

			
1			
No.	507433	Ref. No.	L2160
description	end cap for wash arm ø 15.5mm		

			
1			
No.	502051	Ref. No.	3325 L3325 L3325+2xL3410 L3325+L3410
description	rinse jet		

			
1			
No.	503167	Ref. No.	L7417
description	wash arm mounting pos. upper L 20mm nozzles 3 ø 12mm		

			
1			
No.	502050	Ref. No.	L3321
description	wash jet		

			
1			
No.	507475	Ref. No.	L3319 L3319+L3410
description	wash jet complete		

			
1			
No.	507428	Ref. No.	L3366
description	wash arm support mounting pos. upper/lower		
For models:	K1300, K660, POLY1000, POLY1500, POLY2000		

rinse arm shafts			
			
1			
No.	507441	Ref. No.	L3356
description	rinse arm shaft		

knobs

producer-specific knobs

LUXIA

			
1			
No.	112287	Ref. No.	L3001
description	knob switch zero mark ø 43mm shaft ø 5x5mm black		
For models:	K1300, POLY1500, POLY2000		

			
1			
No.	112286	Ref. No.	L3002
description	knob switch zero mark ø 43mm shaft ø 6x4.6mm shaft flat upper black		
For models:	K1000QBS, K10QT, K11QS, K12QS, K1300, K400QS, K502QBS, K660, T40, T45, T50		

			
1			
No.	110431	Ref. No.	L3000
description	knob set switch zero mark ø 43mm shaft ø 6x4.6/5x5mm 2-piece		

baskets

warewashing baskets

steel wire baskets round

mix baskets



No.	970520	Ref. No.	L3503
description	mix basket ED ø 455mm H 160mm seat ø 390mm		

plastic baskets round



No.	970826	Ref. No.	L3502
description	mix basket ED ø 410mm H 190mm		

plastic baskets square

mix baskets



No.	971058	Ref. No.	L3510 L7185
description	mix basket L 350mm W 350mm H 150mm		
For models:	K10QT, K11QS, OCEANO35		

gaskets

O-rings

EPDM



No.	504561	Ref. No.	L7104
description	O-ring EPDM thickness 2.62mm ID ø 29.82mm Qty 1 pcs		
For models:	OCEANO35, OCEANO40, OCEANO50, OCEANO60, POLY1000, POLY1500, POLY2000, T40, T45, T50		

No.	510408	Ref. No.	L5107
description	O-ring EPDM thickness 5.34mm ID ø 47mm Qty 1 pcs		
For models:	K1000QBS, K10QT, K11QS, K12QS, K1300, K400QS, K502QBS, K660, OCEANO35, OCEANO40, OCEANO50, OCEANO60, POLY1000, POLY1500, POLY2000, T40, T45, T50		

sealing washers

rubber gaskets



No.	510154	Ref. No.	L7045 L7100
description	flat gasket rubber ED ø 33mm ID ø 26mm thickness 2mm Qty 1 pcs		
For models:	OCEANO35, OCEANO40, OCEANO50, OCEANO60, POLY1000, POLY1500, POLY2000, T40, T45, T50		



No.	507479	Ref. No.	L5113
description	flat gasket rubber ED ø 55mm ID ø 42mm thickness 1mm Qty 1 pcs		
For models:	K1000QBS, K1300, K400QS, K502QBS, K660, POLY1000, POLY1500, POLY2000		



No.	512402	Ref. No.	L7099
description	gasket rubber ED ø 105mm ID ø 85mm thickness 3mm Qty 1 pcs		
For models:	T40, T45, T50		
accessories for	512402		



No.	519558	Ref. No.	L7007
description	locknut ED ø 105mm H 19mm ID ø 76mm		



No.	519559	Ref. No.	L7006
description	intake/drain body ED ø 110mm ID ø 85mm outlet ø 45 outlet 2 ø 26		



No.	507476	Ref. No.	L5111
description	gasket rubber ED ø 50mm ID ø 34mm thickness 2mm Qty 1 pcs		
For models:	K10QT, K11QS, K12QS, OCEANO35, OCEANO40, OCEANO50, OCEANO60		



refrigeration cycle components

valves

Schrader valves

valve bodies



1

No.	750097	Ref. No.	N14007
description	valve body for Schrader valve thread 1/4" SAE connection 6mm soldering connection		

dosing pumps

peristaltic dosing pumps





GERMAC

built-in version

with frequency control



1

No.	361620	Ref. No.	L1308 L7002 L7215
description	dosing pump GERMAC frequency control 2.5l/h 230VAC detergent hose ø 4x6mm hose thermoplastic type G252 dimensions 62x70x93mm		
For models:	K1300, OCEANO35, OCEANO40, OCEANO50, OCEANO60, POLY1000, POLY1500, POLY2000		
spare parts for	361620		
	No.	361263	Ref. No. —
	roller assembly GERMAC suitable for G80/82/150/152/200/202/250/252/600		
	No.	361554	Ref. No. —
	pump hose GERMAC detergent hose type thermoplastic hose ø 5x8mm for model G200/G250/G252		
	No.	361556	Ref. No. —
	control PCB type G82/G152/G202/G252 GERMAC		
accessories for	361620		
	No.	520090	Ref. No. —
	PVC hose ID ø 4mm ED ø 6mm L 2m thickness 1mm t.max. 60°C transparent		
	No.	520091	Ref. No. —
	nylon hose ID ø 4mm ED ø 6mm L 2m thickness 1mm operating p. 10bar burst p. 50bar t.max. 100°C transparent		



membrane dosing pumps

self-priming

various



1

No.	361015	Ref. No.	L1504 L7012 L7013 L7219 L7374
description	dosing pump membrane dosing pump rinse aid inlet 6x8mm outlet 4x6mm pressure connection ø 4x6mm suction connection ø 6x8mm		
For models:	K1000QBS, K10QT, K11QS, K12QS, K1300, K400QS, K502QBS, K660, OCEANO35, OCEANO40, OCEANO50, OCEANO60, POLY1000, POLY1500, POLY2000, T40, T45, T50		
spare parts for	361015		
	No.	361132	Ref. No. —
	membrane dosing pump		
	No.	510298	Ref. No. —
	lip valve dosing pump suitable for DB2/DS5		

hoses

supply hoses

stainless steel flexi hoses

universal hoses

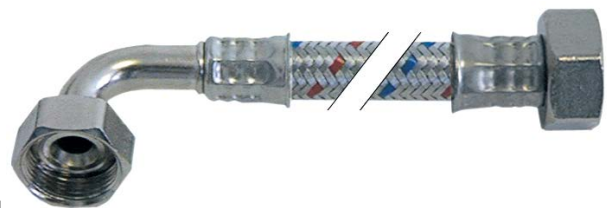

1



No.	520008	Ref. No.	L3008
description	flex hose SS braid straight-curved DN12 connection 1: 3/4" connection 2: 3/4" L 1500mm approval DVGW operating p. 10bar test pressure 32bar burst p. 95bar		
For models:	K1300, POLY2000		
accessories for	520008		
	No.	520054	Ref. No. —
	flat gasket rubber ED ø 23.5mm ID ø 14mm thickness 2.3mm Qty 10 pcs		

drain hoses



1

No.	530570	Ref. No.	L3006
description	drain hose DN21 L 2000mm A int. ø 21mm A ext. ø 25mm B int. ø 20/29mm B ext. ø 27/35mm outer hose ø 25mm		
For models:	K1000QBS, K1300, K400QS, K502QBS, K660, OCEANO50, OCEANO60, POLY1000, POLY1500, POLY2000		

fittings, hose and pipe connectors

hose connectors

without screw connection



1

No.	518347	Ref. No.	L3092
description	T-piece plastic hose ø 10-10-10mm 3-way		
For models:	K1000QBS, K10QT, K11QS, K12QS, K400QS, K502QBS, OCEANO35, OCEANO40		

ancillary products

clamps

hose clamps

DIN 3017 - W2



1

No.	520112	Ref. No.	L3390
description	hose clamp ø 12-20mm width 9mm Qty 10 pcs DIN 3017		
For models:	K1000QBS, K10QT, K11QS, K12QS, K1300, K400QS, K502QBS, K660, POLY1000, POLY1500, POLY2000, T40, T45, T50		

measuring equipment

thermometers

built-in thermometers



1

No.	541568	Ref. No.	L7062
description	thermometer mounting measurements 62x11mm 0 up to +120°C capillary pipe 1500mm probe ø 6mm probe L 32mm		
For models:	POLY2000, T40, T50		

fastening material

nuts

knurled nuts



1

No.	507434	Ref. No.	L3382
description	knurled nut thread M17x1 ø 30mm H 5mm SS		
For models:	K1300		

hexagonal nuts

hexagonal nuts inch thread



1

No.	507477	Ref. No.	L3311
description	nut thread 1" ø 50mm H 7.5mm WS 36 brass Qty 1 pcs		
For models:	K10QT, K11QS, K12QS		



1

No.	507480	Ref. No.	L3314
description	nut thread 1¼" ø 58mm H 8mm WS 44 brass Qty 1 pcs		
For models:	K1000QBS, K1300, K400QS, K502QBS, K660, POLY1000, POLY1500, POLY2000		



fasteners

clamps

hose clamps

DIN 3017 - W2



1

No.	520112	Ref. No.	L3390
description	hose clamp ø 12-20mm width 9mm Qty 10 pcs DIN 3017		
For models:	K1000QBS, K10QT, K11QS, K12QS, K1300, K400QS, K502QBS, K660, POLY1000, POLY1500, POLY2000, T40, T45, T50		