

Professionall

Solutii profesionale pentru echipamente profesionale



GAS COMPONENTS



ELECTRIC COMPONENTS



WATER TECHNOLOGY



MECHANICAL COMPONENTS



TOOLS

Spare parts suitable for

KASTEL



thermostats

bi-metal thermostats

safety bi-metal thermostats



No.	390578	Ref. No.	K00076
description	bi-metal safety thermostat hole distance 25mm 1NC 1-pole		

refrigeration thermostats

RANCO

K22 series

RANCO



No.	390579	Ref. No.	K00080 (old version)
description	thermostat RANCO type K22L1081 probe \varnothing 2mm probe Lmm capillary pipe 2250mm		

K50 series

RANCO



No.	390286	Ref. No.	K00079
description	thermostat RANCO type K50L3383 probe \varnothing mm probe Lmm capillary pipe 1500mm temperature range +1 up to +3°C		

miscellaneous producers



No.	390996	Ref. No.	K00080
description	thermostat probe \varnothing 2mm probe Lmm capillary pipe 2250mm type K22L1081		

switches and momentary switches

microswitches

lever actuated



No.	346872	Ref. No.	601003
description	microswitch with lever 250V 0.1A 1CO connection male faston 6.3mm L 50mm ambient temperature max. 85°C mounting distance 22mm type D41X actuating force: 6g lever length 36mm		

float switches

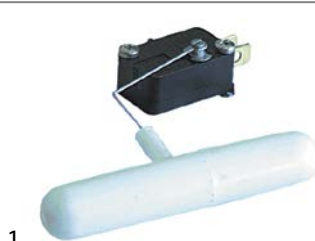

No.	345372	Ref. No.	601043
description	float switch 1CO \varnothing 15mm L 104mm 250V 6A male faston 6.3mm cable lengthmm		





No.	345371	Ref. No.	601082
description	float switch with plunger 250V 16A 1CO male faston 6.3mm L 60mm ambient temperature max. 125°C mounting distance 22mm type EF83161.5 actuating force: 20g blue/black		

timers

programme timers



No.	360368	Ref. No.	K00257	
description	timer CDC 11904 engines 1 chambers 4 operation time 10min 230V manuf. no. 11904F1 / K00257 motor type M48R ATS			
spare parts for	360368			
	No.	360118	Ref. No.	—
	motor CDC pinion \varnothing 4.9mm teeth 10 230V voltage AC 50/60Hz turn direction right motor \varnothing 47mm H 19.3mm motor type M48R ATS for timer cable length 260mm 1.9/2.5W			



1

No.	360367	Ref. No.	K00075
description	timer CDC 11904 engines 1 chambers 4 operation time 12min 230V shaft ømm shaft Lmm manif. no. 11904F1 / K00075 motor type M48R ATS		
spare parts for	360367		
	No.	360118	Ref. No.
			—
description	motor CDC pinion ø 4.9mm teeth 10 230V voltage AC 50/60Hz turn direction right motor ø 47mm H 19.3mm motor type M48R ATS for timer cable length 260mm 1.9/2.5W		

contactors

LOVATO

power contactors



1

No.	380964	Ref. No.	00005140
description	power contactor resistive load 20A 230VAC (AC3/400V) 9A/4kW main contacts 4NO auxiliary contacts connection screw connection type 11BG09T4A230		

probes

producer-specific probes

probes



1

No.	379851	Ref. No.	K04678
description	temperature probe NTC 10kOhm cable silicone probe -40 up to +110°C cable -50 up to +180°C connection plug thread probe ø6x-50mm cable length 1.5m		



1

No.	403223	Ref. No.	K04677
description	temperature probe NTC 10kOhm cable silicone probe -40 up to +110°C cable -50 up to +180°C connection plug thread probe ø6x-50mm cable length 2m		



1

No.	401892	Ref. No.	K01473
description	temperature probe NTC 10kOhm cable TPE probe -40 up to +110°C cable -40 up to +110°C connection plug thread probe ø6x14mm cable length 1.5m		



1

No.	401891	Ref. No.	K01472
description	temperature probe NTC 10kOhm cable TPE probe -40 up to +110°C cable -40 up to +110°C connection plug thread probe ø6x14mm cable length 2m		

electronics

PCBs



1

No.	401890	Ref. No.	K01471 K04601
description	PCB		



1

No.	403100	Ref. No.	K04720
description	PCB ice maker KP 75 L 115mm W 95mm 230V		
accessories for	403100		
	No.	379851	Ref. No.
			K04678
description	temperature probe NTC 10kOhm cable silicone probe -40 up to +110°C cable -50 up to +180°C connection plug thread probe ø6x-50mm cable length 1.5m		
	No.	403223	Ref. No.
			K04677
description	temperature probe NTC 10kOhm cable silicone probe -40 up to +110°C cable -50 up to +180°C connection plug thread probe ø6x-50mm cable length 2m		

solenoïd valves

solenoïd valves (water)



1

No.	370400	Ref. No.	K01213
description	solenoïd valve single angled 230VAC inlet 3/4" outlet 11.5mm input/ min output 1.5l/min DN10 t.max. 90°C ELBI plastic flow regulating valve outlet white		



TP

solenoid valves with reducers

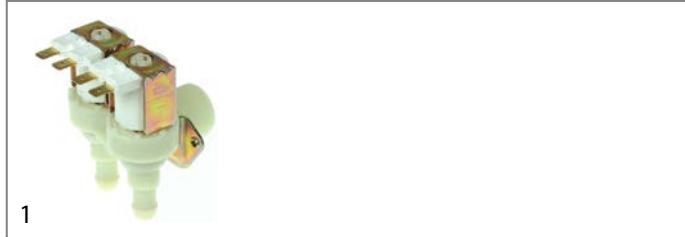

No.	370398	Ref. No.	K01195
description	solenoid valve double angled 230VAC inlet 3/4" input 12l/min t.max. 90°C TP plastic flow regulating valve inlet blue outlet 11.5mm output A 2.5l/min output B 2.5l/min flow regulating valve outlet A yellow flow regulating valve outlet B yellow		



No.	370395	Ref. No.	K01045 K01046
description	solenoid valve double angled 230VAC inlet 3/4" input/min output 0.8/0.8l/min DN10 t.max. 90°C TP plastic outlet 11.5mm output A 0.8l/min output B 0.8l/min flow regulating valve outlet A white flow regulating valve outlet B white		

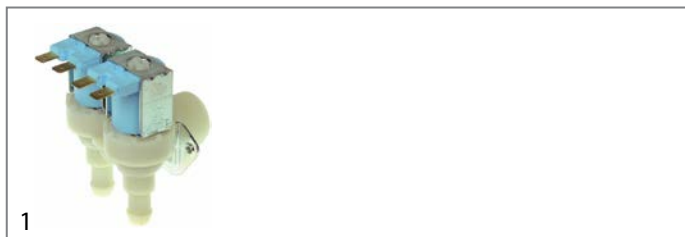

No.	370397	Ref. No.	K01322
description	solenoid valve double angled 230VAC inlet 3/4" input/min output 1.5/2.5l/min DN10 t.max. 90°C TP plastic outlet 11.5mm flow regulating valve outlet A light brown flow regulating valve outlet B yellow		



No.	370396	Ref. No.	K00204
description	solenoid valve double angled 230VAC inlet 3/4" t.max. 90°C TP plastic flow regulating valve inlet white outlet 11.5mm output A 1.5l/min output B 1.5l/min flow regulating valve outlet A light brown flow regulating valve outlet B light brown		

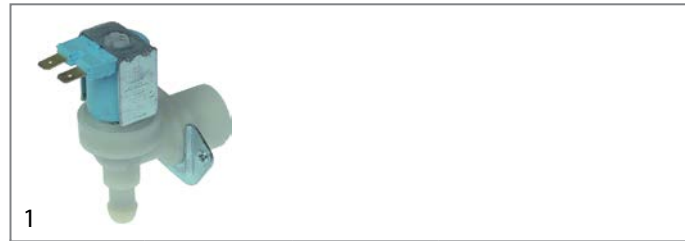

No.	370399	Ref. No.	K01212
description	solenoid valve single angled 230VAC inlet 3/4" outlet 11.5mm input/min output 0.8l/min DN10 t.max. 90°C TP plastic		

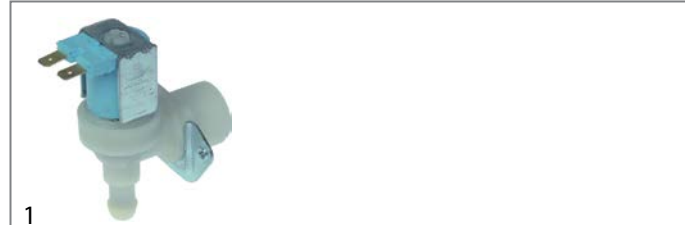

No.	370401	Ref. No.	K01214
description	solenoid valve single angled 230VAC inlet 3/4" outlet 11.5mm output 2.5l/min t.max. 90°C TP plastic flow regulating valve outlet yellow		

solenoid valves (refrigeration)

CASTEL valves



No.	370402	Ref. No.	K01531
description	solenoid valve CASTEL type 1028/2 230V p max 45bar 1/4" connection 1/4" -35 up to 110°C refrigeration copper/brass DN 6.35mm		

spare parts and accessories

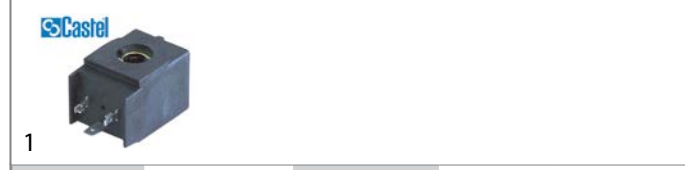

No.	371041	Ref. No.	K01381
description	solenoid coil CASTEL 240VAC 8VA 50/60Hz seat ø 11.5mm connection DIN 43650A type HM2		

accessories for	371041		
------------------------	--------	--	--

	No.	371090	Ref. No.	—
		power socket plug type DIN 43650A screw		

	No.	371092	Ref. No.	—
		power socket plug type DIN large cable length 1000mm		



pressure switches

for refrigeration

RANCO

DWFK series



1		K00077	
No.	541853	Ref. No.	K00077+K01106+K00489 K02908+K01106+K00489 K02908+K01106+K01078
description		pressure control RANCO type HR10811A4R001 switching diff.bar pressure range 17.5bar	

SAGI NO MIYA

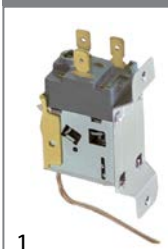

1		K00077	
No.	541120	Ref. No.	K00077
description		pressure control HD reset automatic refrigeration type HTB-X3028 connection male faston 6.3mm switch-on pressure 17bar	

compressors

EMBRACO / ASPERA



R404a/R507

HMBP monophase

High/Medium evaporation temperature above -20/-15 °C



1		K00475	
No.	605132	Ref. No.	K00475
description		compressor coolant R404a/R507 type NT6222GK 200-240V 50Hz HMBP fully hermetic 17kg 1HP cylinder capacity 17.39cm ³ CSR H 252mmWW 810W 1032W 1040W 1174W 1307W 1583W 2247W test method ASHRAE	
accessories for		605132	
		No.	365142
		Ref. No.	—
		operating capacitor capacity 15µF 450V with metal case tolerance 5% 50/60Hz ø 40mm L 110mm M8x1.25	

accessories for		605132	
		No.	365153
		Ref. No.	—
		starting capacitor 52µF 330V 50/60Hz duty cycle 3s 41280A133 2252347 ø 36mm L 83mm M8 plastic connection cable 350mm	
		No.	390981
		Ref. No.	—
		klixon suitable for NT6222GK	

L'UNITE HERMETIQUE / TECUMSEH

R404A

HMBP monophase

High/Medium evaporation temperature above -20/-15 °C



1		K01186	
No.	605025	Ref. No.	K01186
description		compressor coolant R404A type AE4430Z-FZ 220-240V 50Hz HMBP fully hermetic 10.2kg 1/4HP power input 427W cylinder capacity 5.7cm ³ CSIR H 186mmWW 258W 346W 441W 550W 682W 794W test method EN 12900 908W	
spare parts for		605025	
		No.	380061
		Ref. No.	—
		start relay MTRP0027-31 120/240V voltage AC 8A 1NO	



1		K00085	
No.	605023	Ref. No.	K00085
description		compressor coolant R404A type AE4450Z 220-240V 50Hz HMBP fully hermetic 12.5kg 3/8HP cylinder capacity 8.85cm ³ CSIR H 207mmWW 434W 567W 734W 927W 1270W 1367W test method EN 12900 1729W	



1

No.	605021	Ref. No.	K00200
description	compressor coolant R404A type AEZ4425Z 220-240V 50Hz HMBP fully hermetic 9.8kg 1/5HP cylinder capacity 4.5cm ³ CSIR H 186mmWW 198W 263W 341W 432W 537W 629W test method EN 12900 723W		



1

No.	605022	Ref. No.	K00202
description	compressor coolant R404A type AEZ4440Z 230V 50Hz HMBP fully hermetic 21kg cylinder capacity 7.55cm ³ CSIR H 292mm 415W 517W 637W 772W 919W 1074W test method EN 12900 1234W		



1

No.	605027	Ref. No.	K00476
description	compressor coolant R404A type CAJ4517Z 220-240V 50Hz HMBP fully hermetic 24kg 1.2HP cylinder capacity 25.95cm ³ CSIR H 282mmWW 1588W 1987W 2451W 2971W 3536W 4132W test method EN 12900 4742W		



1

No.	605026	Ref. No.	K00206
description	compressor coolant R404A type CAJ9480Z 220-240V 50Hz HMBP fully hermetic 22kg 3/4HP cylinder capacity 15.2cm ³ CSIR H 271mm 393W 571W 774W 1009W 1284W 1607W 1989W 2334W test method EN 12900 2699W		



1

No.	605032	Ref. No.	K00475 old
description	compressor coolant R404A type CAJ9510Z 220-240V 50Hz HMBP fully hermetic 23kg 1HP cylinder capacity 18.3cm ³ CSIR H 282mm 527W 732W 970W 1252W 1583W 1972W 2437W 2826W test method EN 12900 3220W		

fans

refrigeration fans

refrigeration motors universal

accessories

fan wheels

aluminium



1

No.	601566	Ref. No.	K01301
description	fan wheel sucking ø 154mm fan wheel mounting 25.4mm blade angle 28° W 34mm aluminium		

plastic



1

No.	601395	Ref. No.	K01023
description	fan wheel sucking ø 154mm fan wheel mounting 25.4mm blade angle 28° W 32mm plastic		

cooling motors (complete)



No.	601396	Ref. No.	K01380
description	fan 230V 10W 50/60Hz fan wheel ø 172mm shaft L 16mm feet depth 53mm L 66mm W 83mm H 83mm blade angle 32° connection cable 500mm		
spare parts for	601396		
	No.	601553	Ref. No. —
	fan wheel sucking ø 172mm fan wheel mounting 25.4mm blade angle 28° W 35mm aluminium		



No.	601397	Ref. No.	K01083
description	fan 230V 10W 50Hz fan wheel ø 154mm shaft L 125mm feet depth 72mm blade angle 28° connection cable 1000mm		

motors

gear motors

for ice-cube maker

for paddles



No.	500422	Ref. No.	606003
description	gear motor ITV type MT6b-GB5FS 3.5W 230V 50Hz 30rpm shaft ø 6mm L 64mm W 51mm H 40mm for ice-cube maker		



No.	500407	Ref. No.	601039
description	gear motor LIP type 123MR 8W 220/240V voltage AC 50/60Hz 50rpm turn direction counterclockwise shaft ø 4mm shaft intake ø 6.2mm groove width 2.3mm shaft L 8mm shaft ø 4mm W 74mm		

for sumps



No.	500412	Ref. No.	601040
description	gear motor LIP type 021B 11W 230V 50Hz 1rpm shaft ø 7mm shaft length 20mm W 74mm D 67mm H 110mm for sump		

pumps

pumps for ice machines



No.	501494	Ref. No.	K02941
description	pump GRE 100W 230V 50Hz inlet ø 24mm outlet ø 21mm L 227mm		



No.	500200	Ref. No.	K01530
description	pump GRE 100W 230V 50Hz inlet ø 24mm outlet ø 23mm L 145mm rotation direction right		





1

No.	500587	Ref. No.	K00553 K01206
description	pump OLYMPIA type L63.T19ICE 190W 230V 50Hz inlet ø 28mm outlet ø 26mm impellor ø 48mm L 200mm rotation direction right for ice-cube maker capacitor 5µF		
spare parts for	500587		
	No.	601395	Ref. No. K01023
	fan wheel sucking ø 154mm fan wheel mounting 25.4mm blade angle 28° W 32mm plastic		



1

No.	500963	Ref. No.	K01164 K01207
description	pump OLYMPIA type T.19 190W 230V 50Hz inlet ø 28mm outlet ø 26mm impellor ø 65mm L 200mm rotation direction right for ice-cube maker capacitor 5µF		
spare parts for	500963		
	No.	601566	Ref. No. K01301
	fan wheel sucking ø 154mm fan wheel mounting 25.4mm blade angle 28° W 34mm aluminium		



1

No.	500161	Ref. No.	600062
description	pump REBO type NR40 55W 230V 50Hz outlet ø 17mm L 110mm rotation direction left for ice-cube maker		
spare parts for	500161		
	No.	500970	Ref. No. —
	pump motor 55W 230V 50Hz REBO L 205mm type outlet ømm suitable for for ice maker		

equipment-specific units

for ice-cube maker

drain systems

drain fittings



1

No.	695350	Ref. No.	K00004
description	drain fitting thread M28x2 L 23mm straight for ice maker		



1

No.	695347	Ref. No.	K00006
description	drain fitting thread M32x1.5 L 49.3mm straight connection 15mm for ice maker		

overflow pipes



1

No.	695346	Ref. No.	K01317
description	overflow pipe for ice maker tube ø 2.6mm pipe length 95.5mm		

spray systems

KASTEL

spray arms



1

No.	694716	Ref. No.	K02896
description	spray arm L 290mm nozzles 6 plastic for ice maker		



1

No.	695330	Ref. No.	K00171 K02205
description	spray arm L 290mm nozzles 6 stainless steel for ice maker		



1

No.	695329	Ref. No.	K00825 K02203 K02897
description	spray arm L 335mm nozzles 6 for ice maker		

			
1	No.	Ref. No.	K04293
	No.	750391	
description	spray arm L 445mm nozzles 10 for ice maker		

			
1	No.	Ref. No.	K00133 K02207
	No.	695331	
description	spray arm L 445mm nozzles 9 for ice maker		

			
1	No.	Ref. No.	K02898
	No.	696627	
description	spray arm L 445mm nozzles 9 for ice maker		

			
1	No.	Ref. No.	K00047 K02209 K02899
	No.	695332	
description	spray arm L 675mm nozzles 15 for ice maker		

			
1	No.	Ref. No.	K00316 K02211 K02900
	No.	695333	
description	spray arm L 725mm nozzles 18 for ice maker		

accessories

			
1	No.	Ref. No.	K00527
	No.	695335	
description	end cap for ice maker		

doors

			
1	No.	Ref. No.	K03401
	No.	696662	
description	door for ice maker W 297mm H 197mm thickness 24mm blue		

			
1	No.	Ref. No.	K04158
	No.	696663	
description	door for ice maker W 297mm H 197mm thickness 24mm grey		

			
1	No.	Ref. No.	K00816
	No.	695307	
description	door for ice-cube maker W 303mm H 185mm thickness 22mm		

			
1	No.	Ref. No.	K00828
	No.	695306	
description	door for ice-cube maker W 303mm H 185mm thickness 23mm		

			
1	No.	Ref. No.	K00241
	No.	695308	
description	door for ice-cube maker W 337mm H 215mm thickness 23mm		

			
1	No.	Ref. No.	K00245
	No.	695309	
description	door for ice-cube maker W 447mm H 215mm thickness 23mm		



			
1			
No.	695310	Ref. No.	K00249
description	door for ice-cube maker W 677mm H 315mm thickness 23mm		

			
1			
No.	695311	Ref. No.	K00456
description	door for ice-cube maker W 725mm H 315mm thickness 23mm		

curtains with holder

			
1			
No.	695300	Ref. No.	K00826
description	curtain for ice maker W 283mm H 160mm with holder shaft length 260mm shaft ø 7.5mm		

			
1			
No.	695301	Ref. No.	K00225
description	curtain for ice maker W 320mm H 160mm with holder shaft length 310mm shaft ø 7.5mm		

			
1			
No.	695302	Ref. No.	K00653
description	curtain for ice maker W 432mm H 160mm with holder shaft length 430mm shaft ø 7.5mm		

			
1			
No.	695303	Ref. No.	K00556
description	curtain for ice maker W 660mm H 160mm with holder shaft length 660mm shaft ø 7.5mm		

			
1			
No.	695304	Ref. No.	K00227
description	curtain for ice maker W 720mm H 202mm with holder shaft length 705mm shaft ø 7.5mm		

accessories

lamellas

			
1			
No.	695305	Ref. No.	K00008
description	lamella for curtain L 70mm W 25mm ID ø 8mm		

suction system

intake filters

			
1			
No.	695341	Ref. No.	K00012
description	intake filter L 60mm ø 28mm		

pipes

			
1			
No.	695344	Ref. No.	K0058
description	aspiration tube		

gaskets

miscellaneous



1

No.	695348	Ref. No.	K00536
description	sealing ring rubber ED ø 42mm ID ø 33mm thickness 2mm Qty 1 pcs		



1

No.	695351	Ref. No.	K00003
description	sealing ring rubber ED ø 45mm ID ø 27mm thickness 2mm Qty 1 pcs		

hoses

formed hoses

straight

miscellaneous



1

No.	695327	Ref. No.	K00311
description	formed hose straight for ice-cube maker ID ø 17mm ED ø 25mm L 100mm		

form L



1

No.	695314	Ref. No.	K00824
description	formed hose L-shape for ice-cube maker ID ø 17/23mm ED ø 26/30mm L 220mm W 60mm		



1

No.	695328	Ref. No.	K00048 K03462
description	formed hose L-shape for ice-cube maker ID ø 17mm ED ø 24mm L 90mm W 50mm		



1

No.	695326	Ref. No.	K00444
description	formed hose L-shape for ice-cube maker ID ø 17mm ED ø 25mm L 115mm W 50mm		



1

No.	695325	Ref. No.	K00445
description	formed hose L-shape for ice-cube maker ID ø 17mm ED ø 25mm L 195mm W 80mm		

form S



1

No.	695312	Ref. No.	K00110
description	formed hose S-shape for ice-cube maker ID ø 22mm ED ø 30mm L 88mm W 50mm		

form U

group 1



1

No.	695318	Ref. No.	K00141
description	formed hose U-shape for ice-cube maker ID ø 17/25mm ED ø 26/32mm L 300mm W 110mm		



1

No.	695316	Ref. No.	K00184
description	formed hose U-shape for ice-cube maker ID ø 17/26mm ED ø 26/32mm L 220mm W 100mm		



1

No.	695320	Ref. No.	K00197
description	formed hose U-shape for ice-cube maker ID ø 17/26mm ED ø 26/32mm L 410mm W 120mm		





1

No.	695324	Ref. No.	K00217
description	formed hose U-shape for ice-cube maker ID ø 17/26mm ED ø 26/32mm L 620mm W 130mm		



			
1			
No.	695322	Ref. No.	K00109
description	formed hose U-shape insulated for ice-cube maker ID ø 17/25mm ED ø 26/32mm L 530mm W 130mm		

group 2			
			
1			
No.	695313	Ref. No.	K00823
description	formed hose U-shape for ice-cube maker ID ø 17/23mm ED ø 26/32mm L 250mm W 60mm		

			
1			
No.	695315	Ref. No.	K00185
description	formed hose U-shape for ice-cube maker ID ø 17/26mm ED ø 26/32mm L 280mm W 80mm		

			
1			
No.	695319	Ref. No.	K00198
description	formed hose U-shape for ice-cube maker ID ø 17/26mm ED ø 26/32mm L 460mm W 100mm		

			
1			
No.	695321	Ref. No.	K00072
description	formed hose U-shape for ice-cube maker ID ø 17/26mm ED ø 26/32mm L 550mm W 100mm		

			
1			
No.	695323	Ref. No.	K00218
description	formed hose U-shape for ice-cube maker ID ø 17/26mm ED ø 26/32mm L 670mm W 100mm		

			
1			
No.	695317	Ref. No.	K00142
description	formed hose U-shape for ice-cube maker ID ø 26/17mm ED ø 26/32mm L 350mm W 85mm		

hose connectors

with thread

			
1			
No.	695352	Ref. No.	K00039
description	hose connector for drain assembly		

without thread

			
1			
No.	695336	Ref. No.	K00578
description	hose connector		

			
1			
No.	695337	Ref. No.	K00001
description	hose connector		

			
1			
No.	695340	Ref. No.	K01805
description	hose connector		

			
1			
No.	695339	Ref. No.	K01806
description	hose connector for hose ID 23-10-10-23mm plastic Qty 1 pcs		

floats

float containers



1

No.	695073	Ref. No.	601002
description	float container		
spare parts for	695073		
	No.	346872	Ref. No. 601003
	microswitch with lever 250V 0.1A 1CO connection male faston 6.3mm L 50mm ambient temperature max. 85°C mounting distance 22mm type D41X actuating force: 6g lever length 36mm		



1

No.	402163	Ref. No.	K03054
description	float container L 150mm 250V cable lengthmm ømm mounting ømm 2CO 12A male faston 6.3mm		
spare parts for	402163		
	No.	348044	Ref. No. —
	microswitch with plunger 250V 16A 1CO connection male faston 4.8mm Lmm L1 27.8mm ambient temperature max. 125°C mounting distance 22mm with lever set type MS1-16 actuating force: 45g white		

miscellaneous



1

No.	695349	Ref. No.	K01126
description	nut H 7mm thread M32x1.5 plastic WS 41 Qty 1 pcs		



1

No.	695345	Ref. No.	K00057
description	pipe for inlet		

equipment feet and end caps

screw-in feet



1

No.	695353	Ref. No.	K01086
description	equipment foot thread L 17mm ø 18mm H 40mm WS 24 Qty 1 pcs		

gaskets

O-rings

EPDM

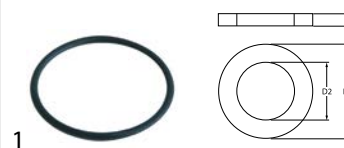

1

No.	510447	Ref. No.	K03089
description	O-ring EPDM thickness 5.34mm ID ø 81.92mm Qty 1 pcs		

silicone

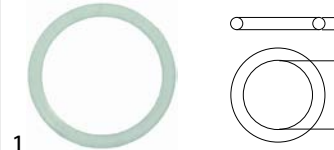

1

No.	532517	Ref. No.	K01125
description	O-ring silicone thickness 1.78mm ID ø 17.17mm Qty 1 pcs		

sealing washers

rubber gaskets



1

No.	695348	Ref. No.	K00536
description	sealing ring rubber ED ø 42mm ID ø 33mm thickness 2mm Qty 1 pcs		



1

No.	695351	Ref. No.	K00003
description	sealing ring rubber ED ø 45mm ID ø 27mm thickness 2mm Qty 1 pcs		



refrigeration cycle components

cooling water regulators

JOHNSON CONTROLS



1

No.	541186	Ref. No.	K00497
description	cooling water regulator 3/8" type V46SA-9951 connection 6mm soldering connection pressure range 5-23bar water pressure max. 18bar water temperature max. 90°C capillary pipe 750mm L 101mm		

filter driers

CASTEL

STANDARD series

suitable for refrigerants R12, R22, R134a, R404A, R407C, R410A, R502, R507

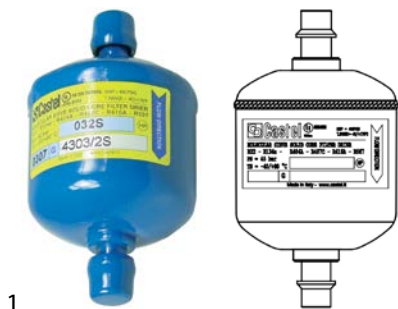

1

No.	750038	Ref. No.	K00081
description	dryer type 4303/2S connection ODS 1/4"-ODM 3/8" 50cm ³ p max 45bar -40 up to +80°C		



1

No.	750039	Ref. No.	K00478
description	dryer type 4305/2S connection ODS 1/4"-ODM 3/8" 80cm ³ p max 45bar -40 up to +80°C 254g		

miscellaneous



1

No.	750222	Ref. No.	K00199
description	dryer size 15g ø 18.9mm L 119mm connection 2,4/6,7mm		

evaporators

for ice-cube maker

for ice cube maker



1

No.	750191	Ref. No.	K00332
description	evaporator for ice-cube maker 108 cubes L 780mm W 275mm H 42mm KP130/75-KP160/75		



1

No.	750188	Ref. No.	K00145
description	evaporator for ice-cube maker 24 cubes L 330mm W 198mm H 40mm KP21/5-KP30/10		

mechanical components, equipment accessories

1



No.	750189	Ref. No.	K00139
description	evaporator for ice-cube maker 36 cubes L 445mm W 198mm H 42mm KP44/15-KP50/26		



No.	750390	Ref. No.	K04122
description	evaporator for ice-cube maker 40 cubes L 445mm W 198mm H 45mm		



No.	750190	Ref. No.	K00138 K04291+K04123
description	evaporator for ice-cube maker 60 cubes L 673mm W 198mm H 45mm KP75/40-KP100/60		

hoses

industrial hoses

PVC hoses

PVC braided hoses

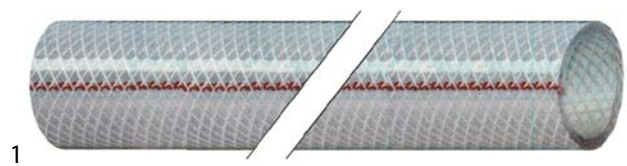

No.	530564	Ref. No.	K00073
description	PVC braided hose ID \varnothing 10mm ED \varnothing 16mm L 10m thickness 3mm operating p. 10bar burst p. 30bar t.max. 60°C		

PVC hoses without fabric

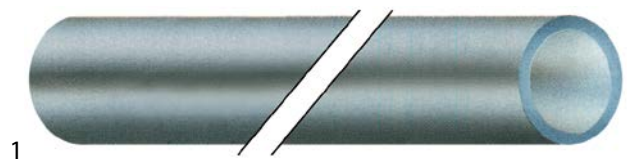

No.	530721	Ref. No.	00003297 K00541 K01209
description	PVC hose ID \varnothing 13mm ED \varnothing 19mm L 5m thickness 3mm transparent		

fittings, hose and pipe connectors

hose connectors

without screw connection



No.	517166	Ref. No.	K00010
description	Y-piece plastic hose \varnothing 10-10-10mm 3-way		



No.	695343	Ref. No.	K00230
description	T-piece plastic hose \varnothing 19-19-19mm 3-way		



hose connectors

producer-specific



1			
No.	695336	Ref. No.	K00578
description	hose connector		



1			
No.	695337	Ref. No.	K00001
description	hose connector		



1			
No.	695340	Ref. No.	K01805
description	hose connector		



1			
No.	695339	Ref. No.	K01806
description	hose connector for hose ID 23-10-10-23mm plastic Qty 1 pcs		

fastening material

screws

knurled screws



1			
No.	695354	Ref. No.	K00013
description	Thumb screw thread M4 thread L 10mm ø 10mm H 6mm SS		