

# Professionall

Solutii profesionale pentru echipamente profesionale



**GAS COMPONENTS**



**ELECTRIC COMPONENTS**



**WATER TECHNOLOGY**



**MECHANICAL COMPONENTS**



**TOOLS**

Spare parts suitable for

# IARP



## heating elements

### heating elements for refrigeration

#### heating elements for defrosting



<b>No.</b>	417669	<b>Ref. No.</b>	0205376
<b>description</b>	heating element 233W 230V L 195mm W 122mm connection male faston 6.3mm cable length 1000mm tube ø 8.5mm defrosting		

### heating cables

#### connection on both sides (metal braided)



<b>No.</b>	417516	<b>Ref. No.</b>	0231005
<b>description</b>	heating cable 40.6W 230V ø 2.6mm L 4600mm 10W/m		

## thermostats

### refrigeration thermostats

#### DANFOSS

##### control thermostats



<b>No.</b>	390774	<b>Ref. No.</b>	0225093 0225178
<b>description</b>	thermostat type 077B3317L capillary pipe 2000mm temperature range -13.6 up to -30.0°C probe ø 2mm		

#### RANCO

##### K22 series

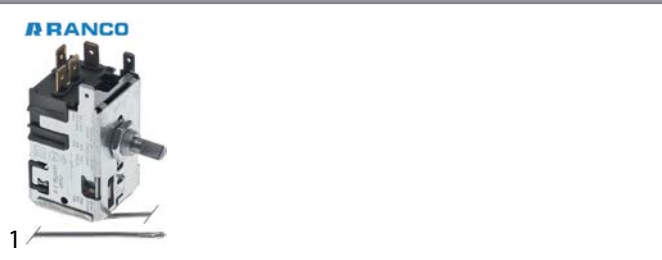

<b>No.</b>	391000	<b>Ref. No.</b>	0225095 3305084 I3305084
<b>description</b>	thermostat RANCO type K22L1067 probe ø 2mm probe L 7mm capillary pipe 1500mm T war 10.5°C T cold -32°C shaft L 11mm shaft 6x4mm		

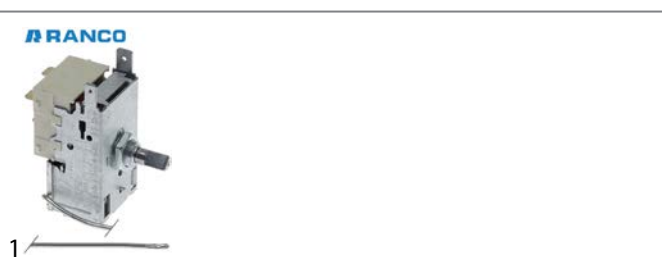

<b>No.</b>	391003	<b>Ref. No.</b>	0225008
<b>description</b>	thermostat RANCO type K22L1067 probe ø 2mm probe Lmm capillary pipe 1500mm T war -10°C T cold -34°C		



<b>No.</b>	390775	<b>Ref. No.</b>	0225105
<b>description</b>	thermostat RANCO type K22L2088 probe ø 2mm capillary pipe 2500mm temperature range -10 up to -20°C		



<b>No.</b>	391007	<b>Ref. No.</b>	3304241
<b>description</b>	thermostat RANCO type K22-L8103 probe ø 2mm probe L 48mm capillary pipe 1500mm T war 10°C T cold -5°C for fridge		

→ electric components

K50 series

RANCO



<b>No.</b>	391008	<b>Ref. No.</b>	3304724
<b>description</b>	thermostat RANCO type K50B-S3492 probe ø 2mm probe Lmm capillary pipe 2500mm T war -19°C T cold -26°C ice maker		

RANCO



<b>No.</b>	390990	<b>Ref. No.</b>	I0225186
<b>description</b>	thermostat RANCO type K50B-S3528 capillary pipe 800mm		

RANCO



<b>No.</b>	390760	<b>Ref. No.</b>	3301323
<b>description</b>	thermostat RANCO type K50-L3210 probe ø 2mm probe Lmm capillary pipe 2500mm temperature range -30 up to -23°C refrigeration		
<b>accessories for</b>	390760		



<b>No.</b>	112654	<b>Ref. No.</b>	3301324
knob ø 22.5mm shaft ø 6x4mm blue for thermostat			

RANCO



<b>No.</b>	391004	<b>Ref. No.</b>	3300683
<b>description</b>	thermostat RANCO type K50-L3313 probe ø 2mm probe Lmm capillary pipe 1500mm for display refrigerator		

RANCO



<b>No.</b>	391002	<b>Ref. No.</b>	0225088 3306115 I3306115
<b>description</b>	thermostat RANCO type K50-L3319 probe ø 2mm probe L 7mm capillary pipe 1000mm temperature range -4,5 up to +7,5°C shaft L 11mm shaft 6x4mm		

RANCO



<b>No.</b>	390757	<b>Ref. No.</b>	0225090
<b>description</b>	thermostat RANCO type K50-L3337 probe ø 2mm probe Lmm capillary pipe 1500mm refrigeration		

RANCO



<b>No.</b>	391005	<b>Ref. No.</b>	3303610
<b>description</b>	thermostat RANCO type K50-L3425 probe ø 2mm probe Lmm capillary pipe 1000mm T war -10°C T cold -30°C for display refrigerator		

RANCO



<b>No.</b>	391006	<b>Ref. No.</b>	0225081 0225185
<b>description</b>	thermostat RANCO type K50L7201 probe ø 2mm probe L 36mm capillary pipe 900mm for fridge		



K57 series



<b>No.</b>	390665	<b>Ref. No.</b>	3302297 3304195
<b>description</b>	thermostat RANCO type K57-L2852 probe ø 10mm probe L 40mm capillary pipe 1200mm		

switches and momentary switches

rocker/momentary rocker switches

30x22mm



<b>No.</b>	301003	<b>Ref. No.</b>	0202083
<b>description</b>	rocker switch mounting measurements 30x22mm green 2NO 250V 16A illuminated 0-I connection male faston 6.3mm ambient temperature max. 125/55°C protection IP65		
<b>accessories for</b>	301003		
	<b>No.</b>	301036	<b>Ref. No.</b> —
	protective cover internal size 30x22mm for rocker switch mounting measurementsmm		



<b>No.</b>	301002	<b>Ref. No.</b>	3305916 I3305916
<b>description</b>	rocker switch mounting measurements 30x22mm orange 2NO 250V 16A illuminated 0-I connection male faston 6.3mm ambient temperature max. 85/125°C protection IP65		
<b>accessories for</b>	301002		
	<b>No.</b>	301036	<b>Ref. No.</b> —
	protective cover internal size 30x22mm for rocker switch mounting measurementsmm		



<b>No.</b>	301009	<b>Ref. No.</b>	0202008 0202030
<b>description</b>	rocker switch mounting measurements 30x22mm white 2NO 250V 16A illuminated 0-I connection male faston 6.3mm ambient temperature max. 125/55°C protection IP65		
<b>For models:</b>	GAYA20-TOP-DOOR		
<b>accessories for</b>	301009		
	<b>No.</b>	301036	<b>Ref. No.</b> —
	protective cover internal size 30x22mm for rocker switch mounting measurementsmm		

push/momentary push switches

27.2x22.2mm



<b>No.</b>	348112	<b>Ref. No.</b>	3301934
<b>description</b>	push switch mounting measurements 27.2x22.2mm 2NO 250V 16A without cap connection male faston 6.3mm ambient temperature max. 55°C		

ø25mm



<b>No.</b>	348109	<b>Ref. No.</b>	0202088 3300972
<b>description</b>	push switch mounting ø 25mm white 2NO 250V 16A light connection male faston 6.3mm ambient temperature max. 55°C		



<b>No.</b>	347536	<b>Ref. No.</b>	0202007
<b>description</b>	push switch mounting ø 25mm white 2NO 250V 16A connection male faston 6.3mm ambient temperature max. 125°C protection IP40		



<b>No.</b>	346003	<b>Ref. No.</b>	0202084
<b>description</b>	momentary push switch mounting ø 25mm red 1NO/indicator light 250V 16A illuminated connection male faston 6.3mm ambient temperature max. 85°C protection IP65		



<b>No.</b>	345161 <sup>1</sup>	<b>Ref. No.</b>	3303454
<b>description</b>	push switch mounting ø 25mm green 2NO 250V 16A illuminated connection male faston 6.3mm ambient temperature max. 85°C protection IP40		

<sup>1</sup>illuminated



<b>No.</b>	345151 <sup>1</sup>	<b>Ref. No.</b>	0202000
<b>description</b>	push switch mounting ø 25mm orange 2NO 250V 16A illuminated connection male faston 6.3mm ambient temperature max. 85°C protection IP40		

<sup>1</sup>illuminated



1

<b>No.</b>	347537	<b>Ref. No.</b>	0202087
<b>description</b>	push switch mounting ø 25mm green 2NO 250V 16A illuminated main switch connection male faston 6.3mm ambient temperature max. 55/120°C protection IP40		

## microswitches

## with push button

## switches with snap-fit



1

<b>No.</b>	345249	<b>Ref. No.</b>	020270
<b>description</b>	microswitch with push button 250V 0.25A 1NO connection male faston 6.3mm L 26x12mm ambient temperature max. 85°C actuating force: 500g		



1

<b>No.</b>	348192	<b>Ref. No.</b>	0202070 I0202070
<b>description</b>	microswitch with push button 250VA 1NO connection male faston 6.3mm L 26x12mm ambient temperature max. 85°C actuating force: 500g		

## lamps

## indicator lights

## indicator lights (complete)

## 30x22mm



1

<b>No.</b>	359157	<b>Ref. No.</b>	0200008
<b>description</b>	indicator light mounting measurements 30x22mm 230V green connection male faston 6.3mm temp.-resist. 125/55°C type RL2		
<b>For models:</b>	GAYA20-TOP-DOOR		
<b>accessories for</b>	359157		
	<b>No.</b>	301036	<b>Ref. No.</b>
			—
	protective cover internal size 30x22mm for rocker switch mounting measurementsmm		



1

<b>No.</b>	359178	<b>Ref. No.</b>	N/A
<b>description</b>	indicator light mounting measurements 30x22mm 230V green connection male faston 6.3mm temp.-resist. 85°C type Marquardt 1667.. IP44		
<b>accessories for</b>	359178		
	<b>No.</b>	301036	<b>Ref. No.</b>
			—
	protective cover internal size 30x22mm for rocker switch mounting measurementsmm		



1

<b>No.</b>	359155	<b>Ref. No.</b>	0200007
<b>description</b>	indicator light mounting measurements 30x22mm 230V red connection male faston 6.3mm temp.-resist. 125°C type RL2		

## fluorescent lamps

## accessories

## ballasts



1

<b>No.</b>	401504	<b>Ref. No.</b>	0206009 3303896
<b>description</b>	electrical ballast 18W 230V Qty 1 pcs		
<b>For models:</b>	GAYA20-TOP-DOOR		



1

<b>No.</b>	401505	<b>Ref. No.</b>	0206012 3303897
<b>description</b>	electrical ballast 36W 230V Qty 1 pcs		
<b>For models:</b>	GAYA20-TOP-DOOR		

## timers

## programme timers



1

<b>No.</b>	403659	<b>Ref. No.</b>	3306879
<b>description</b>	timer CDC 4901F1 engines 1 chambers 1 operation time 20s 230V 50Hz shaft ø 6x4.6mm shaft Lmm		

## defrost timers

## BIGATTI



1

<b>No.</b>	360520	<b>Ref. No.</b>	3301867
<b>description</b>	defrost timer BIGATTI type D94.44 defrosting interval 4x per 24h defrosting time 12.5min 230V 50Hz		

## CDC



1

<b>No.</b>	403603	<b>Ref. No.</b>	I3306873
<b>description</b>	defrost timer CDC type 4901F1CME000.1000 defrosting interval 4x per 24h defrosting time 12.5min 230V 50/60Hz		

## miscellaneous



1

<b>No.</b>	360187	<b>Ref. No.</b>	3300736
<b>description</b>	defrost timer type RZ-2001-21 defrosting interval 4H defrosting time 15min fan delay 5min 230V 50Hz defr. funct. 4x per 24h		

## relays

## power relays

## with bracket mounting

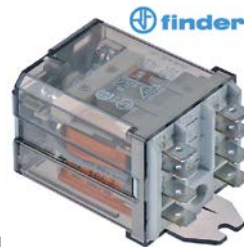

1

<b>No.</b>	380139	<b>Ref. No.</b>	3301894 3301895
<b>description</b>	power relays FINDER 230VAC 16A 2CO connection F6.3 bracket mounting dimensions 68x38.2x35.8mm manuf. no. 62.82.8.230.0000		



1

<b>No.</b>	380687	<b>Ref. No.</b>	3300702
<b>description</b>	power relays FINDER 230VAC 30A 2NO connection F6.3 bracket mounting manuf. no. 66.82.8.230.0300		
<b>For models:</b>	GAYA20-TOP-DOOR		



1

<b>No.</b>	381252	<b>Ref. No.</b>	3301814
<b>description</b>	relay OMRON 230VAC 25A 2NO connection male faston 6.3mm bracket mounting at 250V 25A manuf. no. G7L-2A-TUB 230VAC		





## electronic controllers

## EUREMA

## refrigeration controllers



1

<b>No.</b>	378471	<b>Ref. No.</b>	3304410 3306508 I3306508
<b>description</b>	electronic controller EUREMA type TE11E mounting measurements 58x25mm 230V voltage AC PTC relay outputs 1 NO-16A PTC built-in depth 82mm protection IP65 built-in version -50 up to +50°C display 2 digit		



1

<b>No.</b>	378281	<b>Ref. No.</b>	0233096 3303605
<b>description</b>	electronic controller EUREMA type TE32E mounting measurements 64x32mm 230V voltage AC PTC relay outputs 3 NO-16A NO-8A NO-5A PTC PTC protection IP65 built-in version -50 up to +50°C display 2 digit		

1

<b>No.</b>	378486	<b>Ref. No.</b>	TE32F
<b>description</b>	electronic controller EUREMA type TE32F mounting measurements 58x25mm 230V voltage AC PTC/NTC relay outputs 3 NO-16A CO-10A NO-10A PTC/NTC PTC/NTC DI front measurements 64x32mm built-in depth 82mm protection IP65 accuracy 1% built-in version incl. adaptor 71x29 defr. funct. yes -50 up to +99°C display 2½ digit		

## thermometers



1

<b>No.</b>	379778	<b>Ref. No.</b>	0205115 TE01DEF
<b>description</b>	thermometer EUREMA type TE01 mounting measurements 58x25mm 230V voltage AC -10 up to +55°C PTC display 2 digit front measurements 63x32mm protection IP65 accuracy 1%		



1

<b>No.</b>	378472	<b>Ref. No.</b>	3301028 I3301028
<b>description</b>	thermometer EUREMA type TE01DEF mounting measurements 58x25mm 230V voltage AC°C measuring input PTC display 2½ digit front measurements 64x32mm protection IP65 accuracy 1% PTC		

## accessories



1

<b>No.</b>	378306	<b>Ref. No.</b>	3303038	
<b>description</b>	load module EUREMA type EWEM036 mounting measurements 115x37mm 230V voltage AC relay outputs 3 CO-20A CO-16A CO-10A front measurementsmm built-in depth 70mm protection IPx0 wall-mounted version defr. funct.°C display			
<b>accessories for</b>	378306			
	<b>No.</b>	403555	<b>Ref. No.</b>	3303049
	ribbon cable 5-pole L 1000mm plug type IDC-AUTOCOM HE14, 90° raster size 2.54mm			

## probes

## universal probes

## temperature probes



1

<b>No.</b>	379343	<b>Ref. No.</b>	0205610
<b>description</b>	temperature probe NTC 10kOhm cable silicone probe -40 up to +110°C cable -50 up to +180°C probe ø6x40mm cable length 3m 2-wire		

## producer-specific probes

## probes



1

<b>No.</b>	403910	<b>Ref. No.</b>	I0205805
<b>description</b>	temperature probe NTC 10kOhm cable PVC probe -40 up to +110°C connection 2-wire probe 5x20 cable length 1.475m		



## electronics

### PCBs

			
1			
<b>No.</b>	403736	<b>Ref. No.</b>	43845000 I9R00462
<b>description</b>	control PCB refrigeration IARP L 222mm W 40mm		

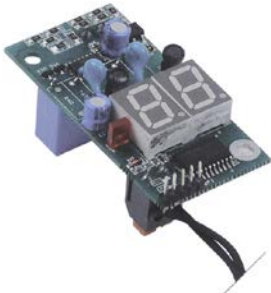
			
1			
<b>No.</b>	402976	<b>Ref. No.</b>	0205600
<b>description</b>	PCB thermometer L 68mm W 33mm cable length 2000mm with probe 230V voltage AC		

## keypads

### front foils



			
1			
<b>No.</b>	403764	<b>Ref. No.</b>	49357000
<b>description</b>	front foil blast freezer L 165mm W 45mm		

## solenoid valves

### solenoid valves (refrigeration)

#### DANFOSS

#### valve bodies

			
1			
<b>No.</b>	370160	<b>Ref. No.</b>	0189035 I0189035
<b>description</b>	solenoid valve body NC type EVR 3 p max 45.2bar DN 3.2mm connection 6mm soldering connection -40° up to 105°C refrigeration straight DANFOSS		
<b>accessories for</b>	370160		
	<b>No.</b>	371046	<b>Ref. No.</b>
	 console for solenoid valve for EVR2,3,6,10		

## compressors

### EMBRACO / ASPERA

#### R134A

#### HBP monophase

High evaporation temperature above -15°C

			
1			
<b>No.</b>	605181	<b>Ref. No.</b>	0210607
<b>description</b>	compressor coolant R134a type EMT50HDP 220-240V 50Hz HBP 7.8kg 1/6HP cylinder capacity 4.5cm <sup>3</sup> RSIR H 166mmWWW 161 W 207W 261W 324W 396W 476W		

#### HMBP monophase

High/Medium evaporation temperature above -20/-15 °C

			
1			
<b>No.</b>	605016	<b>Ref. No.</b>	0210611
<b>description</b>	compressor coolant R134a type EM65HHR 220-240V 50Hz HBP fully hermetic 7.62kg 1/6HP cylinder capacity 5.54cm <sup>3</sup> CSIRWWW 287W 389W 499W 617W 742W test method ASHRAE 842W		





## R290A

LBP monophase

Lower evaporation temperature below -20°C



<b>No.</b>	605258	<b>Ref. No.</b>	I0210981
<b>description</b>	compressor coolant R290 type EMTE2134U 220-240V 50Hz LBP 9kg 3/8HP cylinder capacity 9.5cm <sup>3</sup> CSIR H 187mm 250W 278W 305W 330W 366WWWWWW		



<b>No.</b>	605274	<b>Ref. No.</b>	0210809
<b>description</b>	compressor coolant R290 type NEK2134U 220-240V 50Hz LBP 11kg 1/2HP cylinder capacity 9.99cm <sup>3</sup> CSIR 351W 441W 552W 682W 833WWWWWW test method ASHRAE		



<b>No.</b>	605204	<b>Ref. No.</b>	0210951
<b>description</b>	compressor coolant R290 type NEK2160U 220-240V 50Hz LBP 11.9kg 3/4HP cylinder capacity 16.8cm <sup>3</sup> CSR H 206mm 508W 646W 808W 995W 1206WWWWWW test method ASHRAE		

## R600A

LBP monophase

Lower evaporation temperature below -20°C



<b>No.</b>	605257	<b>Ref. No.</b>	45004031
<b>description</b>	compressor coolant R600a type EMD46CLT 220-240V 50Hz LBP 7.5kg cylinder capacity 7.96cm <sup>3</sup> RSCR H 210mm 88W 118W 154W 196W 246WWWWWW		

## SECOPI DANFOSS

## R134A

HMBP monophase

High/Medium evaporation temperature above -20/-15 °C



<b>No.</b>	605076	<b>Ref. No.</b>	0210109
<b>description</b>	compressor coolant R134a type SC18G 220-240V 50Hz HMBP fully hermetic 13.7kg 1/2HP power input 495W cylinder capacity 17.7cm <sup>3</sup> CSIR H 219mmW 348W 485W 649W 844W 1074W 1343W 1655W 2014W test method ASHRAE		

<b>spare parts for</b>	605076			
	<b>No.</b>	380058	<b>Ref. No.</b>	—
	start relay DANFOSS 117U6019/F278 HST			



<b>No.</b>	605194	<b>Ref. No.</b>	0210107
<b>description</b>	compressor coolant R134a type SC21G 220-240V 50Hz HMBP 13.5kg 5/8HP power input 643W cylinder capacity 20.95cm <sup>3</sup> CSR H 219mmW 410W 558W 746W 977W 1250W 1568W 1931W 2343W test method ASHRAE		



<b>No.</b>	601055 <sup>1</sup>	<b>Ref. No.</b>	0221007	
<b>description</b>	axial fan L 92mm W 92mm H 25mm 230VAC 50/60Hz 14.5/14W bearing ball bearing connection male faston 2.8mm metal ADDA fan wheel ø 85mm temp.-resist. 70°C			
<b>accessories for</b>	601055			
	<b>No.</b>	550898	<b>Ref. No.</b>	0221181 I0221181
	connecting cable cable length 2000mm connection F 2.8 connection distance 7.9mm for axial flow fan			
	<b>No.</b>	691103	<b>Ref. No.</b>	—
	guard ø 90mm mounting distance 83mm for axial fan 92mm			

fans

axial fans

import



<b>No.</b>	601131 <sup>1</sup>	<b>Ref. No.</b>	0221005 0221151 I0221151	
<b>description</b>	axial fan L 119mm W 119mm H 25mm 230VAC 50/60Hz 19/18W bearing ball bearing connection male faston 2.8mm metal ADDA fan wheel ø 110mm temp.-resist. 70°C			
<b>accessories for</b>	601131			
	<b>No.</b>	550898	<b>Ref. No.</b>	0221181 I0221181
	connecting cable cable length 2000mm connection F 2.8 connection distance 7.9mm for axial flow fan			

<sup>1</sup>with ball bearings



<b>No.</b>	601909 <sup>1</sup>	<b>Ref. No.</b>	45003031
<b>description</b>	axial fan L 119mm W 119mm H 38mm 220-240 50/60Hz 31/29W bearing ball bearing connection male faston 2.8mm		

<sup>1</sup>with ball bearings

accessories

fan guards



<b>No.</b>	691104	<b>Ref. No.</b>	0427017 I0427017
<b>description</b>	guard ø 115mm mounting distance 105mm for axial fan 119mm		

connecting cables



<b>No.</b>	550898	<b>Ref. No.</b>	0221181 I0221181
<b>description</b>	connecting cable cable length 2000mm connection F 2.8 connection distance 7.9mm for axial flow fan		



refrigeration fans

refrigeration motors universal

ELCO

N series - standard



<b>No.</b>	601442	<b>Ref. No.</b>	0220067 I0220067
<b>description</b>	fan motor ELCO 10W 230V 50-60Hz bearing slide bearing L1 45mm L3 83mm W 83mm cable length 1800mm 1300/1550rpm 3 mounting options VN10-20/507 triple		
<b>spare parts for</b>	601442		
	<b>No.</b>	601413	<b>Ref. No.</b> —
	fixing plate suitable for fanwheel ED ø 32mm shaft ø 7 mounting distance 26mm		



<b>No.</b>	601762	<b>Ref. No.</b>	0221141
<b>description</b>	fan motor ELCO 10W 230V 50Hz bearing ball bearing L1 49mm L2 59mm L3 86.5mm W 83mm connection cable 500mm cable length 500mm 1300/1550rpm 3 mounting options VN10-20/1456		
<b>spare parts for</b>	601762		
	<b>No.</b>	601413	<b>Ref. No.</b> —
	fixing plate suitable for fanwheel ED ø 32mm shaft ø 7 mounting distance 26mm		



<b>No.</b>	601763	<b>Ref. No.</b>	0221140
<b>description</b>	fan motor ELCO 16W 230V 50/60Hz bearing ball bearing L1 48mm L2 64mm L3 91.5mm W 83mm connection cable 500mm cable length 500mm 1300/1550rpm 3 mounting options VN16-25/1457		
<b>spare parts for</b>	601763		
	<b>No.</b>	601413	<b>Ref. No.</b> —
	fixing plate suitable for fanwheel ED ø 32mm shaft ø 7 mounting distance 26mm		



<b>No.</b>	601735	<b>Ref. No.</b>	0221115 3604962
<b>description</b>	fan motor ELCO 5W 230V 50/60Hz bearing slide bearing L3 71mm W 59mm connection Kabel 1430mm cable length 1500mm 1300/1550rpm 3 mounting options VN5-13/249		

IQ series



<b>No.</b>	601886	<b>Ref. No.</b>	0220087
<b>description</b>	fan motor 14W 230V 50/60Hz L2 35-56mm L3 95mm W 80mm cable length 1000mm 1400rpm ELCO IQ motor 3 mounting options bearing ball bearing		



<b>No.</b>	601887	<b>Ref. No.</b>	0220088
<b>description</b>	fan motor 25W 230V 50/60Hz L2 46-66mm L3 115mm W 90mm cable length 1000mm 1400rpm ELCO IQ motor 3 mounting options bearing ball bearing		



FMI



1

<b>No.</b>	601332	<b>Ref. No.</b>	0220072 I0220072
<b>description</b>	fan motor 16W 230V 50Hz L1 65mm L2 54mm L3 94mm W 77mm cable length 500mm 1300/1550rpm ABS12 5 mounting options bearing slide bearing		
<b>For models:</b>	GAYA20-TOP-DOOR		
<b>spare parts for</b>	601332		
	<b>No.</b>	601413	<b>Ref. No.</b> —
<b>description</b>	fixing plate suitable for fanwheel ED ø 32mm shaft ø 7 mounting distance 26mm		

accessories

fan wheels

aluminium

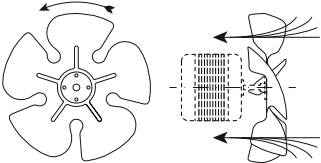
1

<b>No.</b>	601069	<b>Ref. No.</b>	0407004
<b>description</b>	fan wheel sucking ø 172mm turn direction left fan wheel mounting 25.4mm blade angle 25° W 32mm aluminium		

mounting rings



1

<b>No.</b>	601586	<b>Ref. No.</b>	0221128
<b>description</b>	ring for fan wheel ø 172mm sucking ø 220mm H 49mm mounting distance 1 208mm mounting distance 2 94.5mm		



1

<b>No.</b>	601587	<b>Ref. No.</b>	0221116
<b>description</b>	ring for fan wheel ø 200mm sucking ø 246mm H 49mm mounting distance 1 236mm mounting distance 2 94.5mm		

cross flow fans

COPREL

double fans



1

<b>No.</b>	602107	<b>Ref. No.</b>	N/A
<b>description</b>	cross flow fan COPREL TFD roller ø 60mm roller length 2x300mm laminated core thickness 30mm motor position centre 230V/50-60Hz 35W universal bearing silicone connection cable 1600mm airflow 333m <sup>3</sup> /h -10 up to +50°C		

condensators & interference sup-  
pression filters

starting capacitors

starting capacitors



1

<b>No.</b>	365153	<b>Ref. No.</b>	0210402
<b>description</b>	starting capacitor 52µF 330V 50/60Hz duty cycle 3s 41280A133 2252347 ø 36mm L 83mm M8 plastic connection cable 350mm		



## fuses

### line circuit breakers

#### miscellaneous



1			
<b>No.</b>	356000	<b>Ref. No.</b>	I3301770
<b>description</b>	circuit breaker 2 20A with fault current switch		

## electric accessories

### cables

#### power supply cables



1			
<b>No.</b>	552002	<b>Ref. No.</b>	I3306470
<b>description</b>	power lead CEE7/7 type E+F contacts P+N+E 1mm <sup>2</sup> max. 16A max 230V 2.5m		

#### ribbon cables

##### group 6



1			
<b>No.</b>	403555	<b>Ref. No.</b>	3303049
<b>description</b>	ribbon cable 5-pole L 1000mm plug type IDC-AUTOCOM HE14, 90° raster size 2.54mm		

### terminal boxes



1			
<b>No.</b>	551086	<b>Ref. No.</b>	01009
<b>description</b>	terminal box 6-pole L 117mm W 67mm H 22mm protection IP30		

## equipment-specific units

### for fridges

#### spare parts and accessories



1			
<b>No.</b>	551346	<b>Ref. No.</b>	I0534005R
<b>description</b>	bush refrigerator compressor ø 9mm ID ø 6.5mm L 17mm Qty 1 pcs		



1			
<b>No.</b>	699232	<b>Ref. No.</b>	I0535012
<b>description</b>	strain relief L 56mm W 14.5mm H 20mm		

#### housing and bezels

##### covers



1			
<b>No.</b>	998252	<b>Ref. No.</b>	44037000
<b>description</b>	cover for ventilation L 72mm W 62mm H 10mm Qty 1 pcs		

##### control panel



1			
<b>No.</b>	699234	<b>Ref. No.</b>	44027000
<b>description</b>	bezel L 780mm W 67mm H 62mm mounting pos. upper		

##### housings



1			
<b>No.</b>	699233	<b>Ref. No.</b>	I9500323
<b>description</b>	terminal box L 98mm W 74mm H 35mm kit		





## knobs

### producer-specific knobs

IARP



1

<b>No.</b>	112654	<b>Ref. No.</b>	3301324
<b>description</b>	knob ø 22.5mm shaft ø 6x4mm blue for thermostat		

## locks

### locking devices

#### producer-specific

IARP



1

<b>No.</b>	701114	<b>Ref. No.</b>	0423002
<b>description</b>	door catch plastic H 15mm L 40mm W 15mm hole ø 4.2mm mounting distance 14mm for catch		



1

<b>No.</b>	702100	<b>Ref. No.</b>	44373000
<b>description</b>	key cylinder ø 19mm rotation 180° cam length 42.5mm cam width 14mm		



1

<b>No.</b>	701113	<b>Ref. No.</b>	0423001
<b>description</b>	key cylinder rotation 180° cam length 32mm cam width 17mm mounting ø 19mm		

## hinges

### door bearing



1

<b>No.</b>	701562	<b>Ref. No.</b>	44447000
<b>description</b>	bolt L 36mm W 22mm thread M6 bolt 12mm bolt ø 12mm		



1

<b>No.</b>	701025	<b>Ref. No.</b>	0530022
<b>description</b>	bolt L 45mm mounting pos. upper thread M8x1.25 ø 12mm for hinge		
<b>accessories for</b>	701025		



<b>No.</b>	701026	<b>Ref. No.</b>	0162886
------------	--------	-----------------	---------

hinge L 56mm W 50mm mounting pos. upper thickness 3mm



1

<b>No.</b>	701567	<b>Ref. No.</b>	41649000
<b>description</b>	bush L 11mm ø 11/15mm thickness 2mm		



1

<b>No.</b>	701572	<b>Ref. No.</b>	I0534002
<b>description</b>	bush ø 18.5mm ID ø 12mm		



1

<b>No.</b>	692537	<b>Ref. No.</b>	0415134 I0415134
<b>description</b>	door hinge L 68mm W 25mm mounting pos. upper right with plunger		







1

<b>No.</b>	701564	<b>Ref. No.</b>	46996000
<b>description</b>	hinge L 130mm W 85mm H 38mm mounting distance 48mm mounting distance 2 33mm thread M6 ø 8mm bolt 13mm bolt ø 8mm		



1

<b>No.</b>	701026	<b>Ref. No.</b>	0162886
<b>description</b>	hinge L 56mm W 50mm mounting pos. upper thickness 3mm		
<b>accessories for</b>	701026		
	<b>No.</b>	701025	<b>Ref. No.</b> 0530022
<b>description</b>	bolt L 45mm mounting pos. upper thread M8x1.25 ø 12mm for hinge		



1

<b>No.</b>	701027	<b>Ref. No.</b>	0415122
<b>description</b>	hinge L 58mm W 28mm H 73mm mounting pos. lower with bolt		



1

<b>No.</b>	701039	<b>Ref. No.</b>	0160434
<b>description</b>	hinge L 67mm W 43mm H 22mm mounting pos. bottom right		



1

<b>No.</b>	701563	<b>Ref. No.</b>	43870000
<b>description</b>	hinge L 98mm W 48mm H 38mm mounting distance 40mm mounting distance 2 20mm thread M6		



1

<b>No.</b>	701565	<b>Ref. No.</b>	48205000
<b>description</b>	hinge bearing L 72mm W 39mm H 30mm mounting distance 25mm mounting distance 2 25mm mounting pos. left		



1

<b>No.</b>	701566	<b>Ref. No.</b>	46997000
<b>description</b>	hinge bearing L 72mm W 39mm H 30mm mounting distance 25mm mounting distance 2 25mm mounting pos. right		

## equipment feet and end caps

### screw-in feet



1

<b>No.</b>	701112	<b>Ref. No.</b>	0403014 I0403014
<b>description</b>	equipment foot thread M10 thread L 43mm ø 29mm H 52mm plastic WS 35 Qty 1 pcs		

## shelves and shelf rails

### grates

#### universal

#### with upstand



1

<b>No.</b>	970824	<b>Ref. No.</b>	0427743
<b>description</b>	grate W 526mm D 418mm plastic-coated steel with hinge camp crossing wires 2		



1







<b>No.</b>	970556	<b>Ref. No.</b>	0427396
<b>description</b>	grate W 530mm D 650mm GN 2/1 plastic-coated steel with hinge camp wire gauge frame 9mm lengthwise wires gauge 5mm crossing wires 2 white suitable for refrigerator		
<b>accessories for</b>	970556		
	<b>No.</b>	690330	<b>Ref. No.</b> —
<b>description</b>	rack L 1000mm W 22mm H 4mm aperture 3x8mm hole distance 12.5mm stainless steel		
	<b>No.</b>	690332	<b>Ref. No.</b> I0402138
<b>description</b>	shelf support L 31/28mm W 22mm H 17mm SS with hook Qty 1 pcs		
	<b>No.</b>	694700	<b>Ref. No.</b> —
<b>description</b>	shelf support L 31/28mm W 22mm H 18mm SS Qty 12 pcs		

Table continues overleaf





<b>accessories for</b>	970556			
	No.	694701	Ref. No.	—
<b>description</b>	shelf support L 31/28mm W 22mm H 17mm SS with hook Qty 12 pcs			

	1		
No.	970874	Ref. No.	0427709
<b>description</b>	grate W 650mm D 540mm GN 2/1 H 30mm plastic-coated steel with hinge camp for fridge wire gauge frame 7.3mm lengthwise wires gauge 3.2mm crossing wires 2 white		

<b>producer-specific</b>			
	1		
No.	970930	Ref. No.	44714000
<b>description</b>	grate W 650mm D 330mm H 9mm wire gauge frame 7mm lengthwise wires gauge 3mm crossing wires 1		

	1		
No.	970929	Ref. No.	44379000
<b>description</b>	grate W 665mm D 560mm H 30mm wire gauge frame 7mm lengthwise wires gauge 3mm crossing wires 2		

## shelf rails and supports

<b>universal</b>				
	1			
No.	690332	Ref. No.	I0402138	
<b>description</b>	shelf support L 31/28mm W 22mm H 17mm SS with hook Qty 1 pcs			
<b>accessories for</b>	690332			
	No.	690330	Ref. No.	—
<b>description</b>	rack L 1000mm W 22mm H 4mm aperture 3x8mm hole distance 12.5mm stainless steel			

<b>producer-specific</b>			
	1		
No.	699231	Ref. No.	I0402137
<b>description</b>	guide white L 1350mm W 20mm H 5mm Qty 1		

	1		
No.	691835	Ref. No.	0160741
<b>description</b>	shelf support L 28/25mm W 35mm H 19mm		

## gaskets

### refrigeration gaskets

#### plug-in gaskets

##### profile 9050

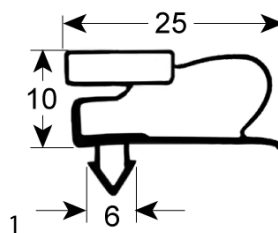

No.	902152	Ref. No.	0313225
<b>description</b>	refrigeration gasket profile 9050 W 560mm L 1585mm plug size		

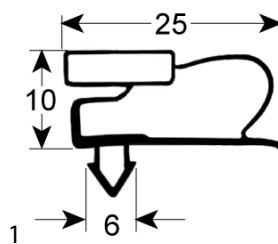

No.	902051	Ref. No.	0313220
<b>description</b>	refrigeration gasket profile 9050 W 700mm L 1505mm plug size		

##### profile 9151

We offer custom-made gaskets for this profile

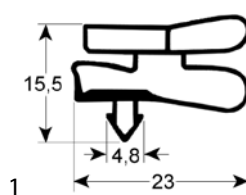

No.	901457	Ref. No.	3303310
<b>description</b>	refrigeration gasket profile 9151 W 495mm L 1440mm plug size		

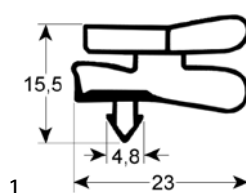

No.	901458	Ref. No.	0313223
<b>description</b>	refrigeration gasket profile 9151 W 535mm L 1690mm plug size		

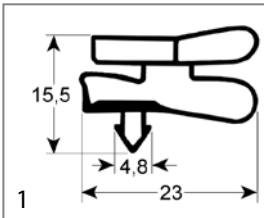

<b>No.</b>	901083	<b>Ref. No.</b>	0313205
<b>description</b>	refrigeration gasket profile 9151 W 550mm L 1722mm plug size L1 1712mm W1 540mm external size		

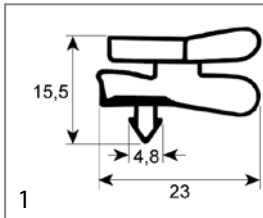

<b>No.</b>	901096	<b>Ref. No.</b>	0313191 3300917
<b>description</b>	refrigeration gasket profile 9151 W 620mm L 890mm plug size		

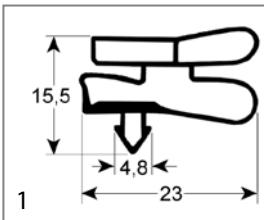

<b>No.</b>	901179	<b>Ref. No.</b>	3302200 I3302200
<b>description</b>	refrigeration gasket profile 9151 W 555mm L 1555mm plug size L1 1545mm W1 545mm external size		

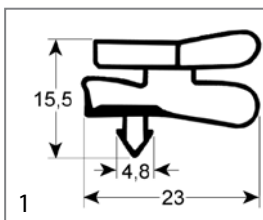

<b>No.</b>	901081	<b>Ref. No.</b>	0313010
<b>description</b>	refrigeration gasket profile 9151 W 634mm L 1391mm external size L1 1381mm W1 624mm plug size		

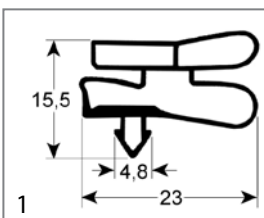

<b>No.</b>	901080	<b>Ref. No.</b>	0313007 I0313007
<b>description</b>	refrigeration gasket profile 9151 W 558mm L 1713mm plug size L1 1703mm W1 548mm external size		

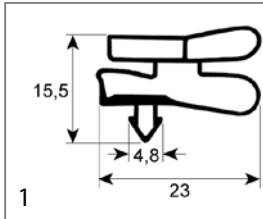

<b>No.</b>	901097	<b>Ref. No.</b>	3300913
<b>description</b>	refrigeration gasket profile 9151 W 637mm L 576mm plug size		

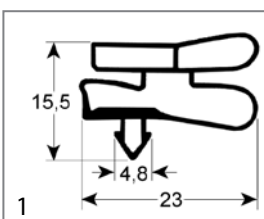

<b>No.</b>	901082	<b>Ref. No.</b>	0313178
<b>description</b>	refrigeration gasket profile 9151 W 585mm L 1390mm plug size L1 1380mm W1 575mm external size		

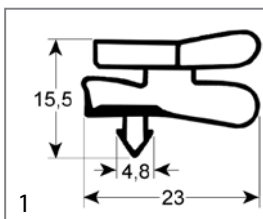

<b>No.</b>	901796	<b>Ref. No.</b>	0313221
<b>description</b>	refrigeration gasket profile 9151 W 655mm L 1534mm		

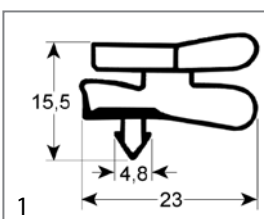

<b>No.</b>	901086	<b>Ref. No.</b>	0313206
<b>description</b>	refrigeration gasket profile 9151 W 620mm L 1522mm plug size L1 1532mm W1 630mm external size		

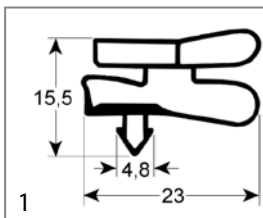

<b>No.</b>	901377	<b>Ref. No.</b>	0313291
<b>description</b>	refrigeration gasket profile 9151 W 715mm L 1674mm plug size L1 1686mm W1 722mm external size		



<b>No.</b>	901322	<b>Ref. No.</b>	0313233
<b>description</b>	refrigeration gasket profile 9151 W 717mm L 1515mm plug size L1 1505mm W1 707mm external size		

<b>No.</b>	901085	<b>Ref. No.</b>	0313200
<b>description</b>	refrigeration gasket profile 9151 W 730mm L 1550mm plug size L1 1540mm W1 720mm external size		

<b>No.</b>	901084	<b>Ref. No.</b>	0313202 0313207
<b>description</b>	refrigeration gasket profile 9151 W 740mm L 1619mm plug size L1 1609mm W1 730mm external size length external size 1625mm width external size 740mm		

**profile 9058**

<b>No.</b>	902395	<b>Ref. No.</b>	44404000
<b>description</b>	refrigeration gasket profile 9058 W 770mm L 1810mm plug size Qty 1		

## refrigeration cycle components

### filter driers

#### miscellaneous

<b>No.</b>	750311	<b>Ref. No.</b>	0145040
<b>description</b>	dryer size 20g ø 19mm L 149mm connection 3,2/6,2mm		

<b>No.</b>	750310	<b>Ref. No.</b>	0145015
<b>description</b>	dryer size 20g ø 19mm L 150mm connection 3.2/5/6.2mm		

## evaporators

### for fridges

#### producer-specific

<b>No.</b>	750621	<b>Ref. No.</b>	0119189
<b>description</b>	evaporator for fridge L 390mm W 325mm IARP		

<b>No.</b>	750342	<b>Ref. No.</b>	0130010
<b>description</b>	evaporator L 1580mm W 660mm suitable for AB500P		

## condensors

### condensors



<b>No.</b>	750703	<b>Ref. No.</b>	44918000
<b>description</b>	condenser W 790mm D 10mm H 1360mm		

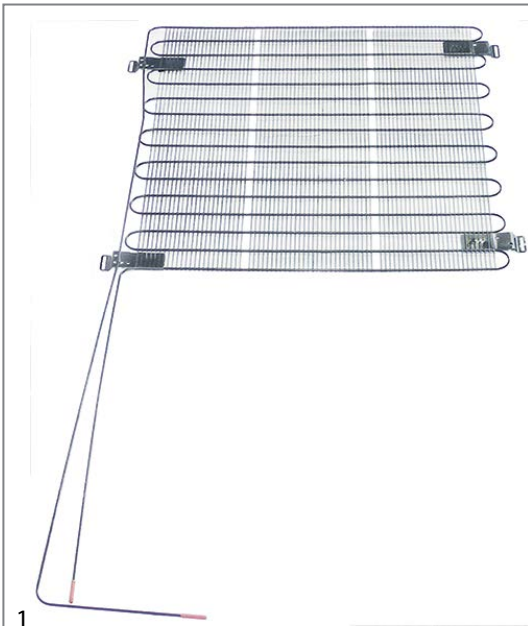

<b>No.</b>	750699	<b>Ref. No.</b>	45034000
<b>description</b>	condenser W 790mm D 10mm H 750mm Qty 1 pcs		

## evaporation and condensing trays

### evaporation trays



<b>No.</b>	699211	<b>Ref. No.</b>	I0425088
<b>description</b>	evaporation tray L 230mm W 144mm H 45mm		

## measuring equipment

### thermometers

#### built-in thermometers



<b>No.</b>	541080	<b>Ref. No.</b>	0406018 3303276
<b>description</b>	thermometer mounting measurements 58x25.5mm -40 up to +40°C capillary pipe 2500mm probe ø 6mm probe L 30mm		
<b>For models:</b>	GAYA20-TOP-DOOR		

#### external power supply



<b>No.</b>	378274 <sup>1</sup>	<b>Ref. No.</b>	0406046
<b>description</b>	thermometer ARTHERMO type ROF-DIG/230 mounting measurements 58x25.5mm front measurements 64x31mm 230V voltage AC -30 jusqu'à +110°C probe ø6x40mm cable length 2500mm display 3 digits		

<sup>1</sup>incl. 1x NTC probe

## fastening material

### washers

#### washers

#### miscellaneous



<b>No.</b>	560486	<b>Ref. No.</b>	0521000
<b>description</b>	plain washer ID ø 14.1mm ED ø 22mm thickness 2mm plastic Qty 1 pcs		
<b>For models:</b>	GAYA20-TOP-DOOR		