

Professionall

Solutii profesionale pentru echipamente profesionale



GAS COMPONENTS



ELECTRIC COMPONENTS



WATER TECHNOLOGY



MECHANICAL COMPONENTS



TOOLS

Spare parts suitable for

GEOFRIGOR



thermostats

refrigeration thermostats

RANCO

K22 series



1

No.	390524	Ref. No.	RFS0B893
description	thermostat RANCO type K22L1082 probe ømm probe Lmm capillary pipe 2000mm temperature range -22 up to -3°C		



1

No.	390296	Ref. No.	RF000618
description	thermostat RANCO type K22-L2069 probe ø 2mm probe L 10mm capillary pipe 1500mm		

K50 series



1

No.	390270	Ref. No.	RF000610
description	thermostat RANCO type K50L3019 probe ømm probe Lmm capillary pipe 1250mm temperature range +1 up to +7.5°C		



1

No.	390286	Ref. No.	RFS0B892
description	thermostat RANCO type K50L3383 probe ømm probe Lmm capillary pipe 1500mm temperature range +1 up to +3°C		

switches and momentary switches

rocker/momentary rocker switches

30x22mm

labelled



1

No.	346870	Ref. No.	RI000751	
description	rocker switch mounting measurements 30x22mm blue 2NO 250V 16A illuminated 0-1 connection male faston 6.3mm ambient temperature max. 85°C protection IP65 with cover cap			
accessories for	346870			
	No.	301036	Ref. No.	—
	protective cover internal size 30x22mm for rocker switch mounting measurementsmm			

push/momentary push switches

19x13mm



1

No.	346871 ¹	Ref. No.	RI00B281	
description	push switch mounting measurements 19x13mm green 2NO 250V 16A illuminated connection male faston 4.8mm ambient temperature max. 105/55°C protection IP40			
accessories for	346871			
	No.	346541	Ref. No.	—
	protective cover for rocker switch external size 23.4x17.4mm internal size 19x13mm H 9.5mm mounting measurementsmm			

¹illuminated

ø25mm



1

No.	345011	Ref. No.	RI00C883	
description	push switch mounting ø 25mm green 2NO 250V 16A illuminated connection male faston 6.3mm ambient temperature max. 85°C protection IP65			
accessories for	345011			
	No.	345039	Ref. No.	—
	protective cover round ED ø 33mm external size 23mm internal size 21mm H 12mm clear mounting ø 25mm			



microswitches

lever actuated



1

No.	346872	Ref. No.	RI000800
description	microswitch with lever 250V 0.1A 1CO connection male faston 6.3mm L 50mm ambient temperature max. 85°C mounting distance 22mm type D41X actuating force: 6g lever length 36mm		

roller-lever actuated

with mounting components



1

No.	347568	Ref. No.	RI00A240
description	microswitch with handle with a switch 250V 10A 1CO connection male faston 6.3mm L 25mm ambient temperature max. 85°C mounting distance 24mm type VR actuating force: 50g lever length 31mm		



1

No.	345370	Ref. No.	RH003800
description	microswitch with handle with a switch 250V 16A 1CO connection male faston 6.3mm L 27mm ambient temperature max. 125°C mounting distance 24mm actuating force: 45g lever length 26.5mm		

float switches



1

No.	345372	Ref. No.	RH000830 RI00A241
description	float switch 1CO ø 15mm L 104mm 250V 6A male faston 6.3mm cable lengthmm		



1

No.	345371	Ref. No.	RH00A310
description	float switch with plunger 250V 16A 1CO male faston 6.3mm L 60mm ambient temperature max. 125°C mounting distance 22mm type EF83161.5 actuating force: 20g blue/black		

floats



1

No.	695044	Ref. No.	RH000679
description	float		

timers

programme timers



1

No.	360524	Ref. No.	RFS0B869	
description	timer CDC 11904 engines 1 chambers 4 operation time 12min 230V shaft ømm shaft Lmm manuf. no. 11904F1 / BDR000.0000 motor type M48R ATS			
spare parts for	360524			
	No.	360118	Ref. No.	—
	motor CDC pinion ø 4.9mm teeth 10 230V voltage AC 50/60Hz turn direction right motor ø 47mm H 19.3mm motor type M48R ATS for timer cable length 260mm 1.9/2.5W			



1

No.	360609	Ref. No.	RFS0C111
description	timer CDC 11904 engines 1 chambers 4 operation time 15min 230V 60Hz shaft ømm shaft Lmm manuf. no. 11904F1BEY000.0010		

relays

power relays

with bracket mounting



1

No.	380312	Ref. No.	RI000761
description	power relays FINDER 230VAC 10A 3CO connection male faston 4.8mm bracket mounting dimensions 52x32.2x36.5mm manuf. no. 60.63.8.230.0000		



relay sockets

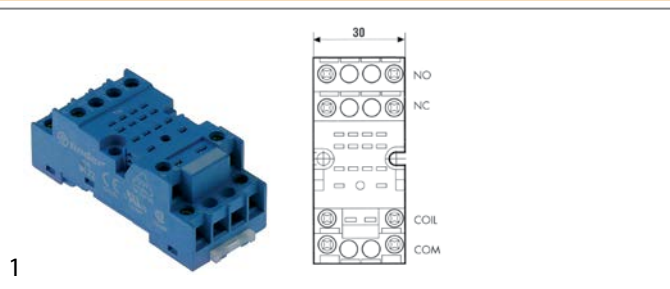

1

No.	380378	Ref. No.	RF000556
description	relay socket 2-pole 55/85 dimensions 70.5x30x27mm 250V voltage AC 10A FINDER manuf. no. 94.72		
accessories for	380378		
	No.	380804	Ref. No. —
	support bracket		

time relays

time relays





1

No.	380770	Ref. No.	RF000555
description	time relay connection plug-in connection round 8-pole		



1

No.	380329	Ref. No.	RF000555
description	time relay FIBER 85.02.8.240 time range 0.05s - 100h 230-240VAC 10A mounting measurements 20.6x27.7mm 2CO connection 2.0		
accessories for	380329		
	No.	380378	Ref. No. RF000556
	relay socket 2-pole 55/85 dimensions 70.5x30x27mm 250V voltage AC 10A FINDER manuf. no. 94.72		
	No.	380803	Ref. No. —
	relay socket 2-pole dimensions 76.2x27x86.1mm 250V voltage AC 10A FINDER manuf. no. 94.92.3		

electronics

PCBs

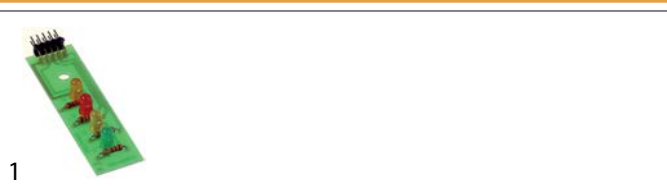

1

No.	401606	Ref. No.	RI00A031
description	display		

solenoïd valves

solenoïd valves (water)

TP



1





















No.	370019	Ref. No.	RF000625
description	solenoid valve double angled 230VAC inlet 3/4" outlet 11.5mm DN10 TP plastic		
spare parts for	370019		
	No.	371013	Ref. No. —
	solenoid coil TP 230VAC 50/60Hz		
accessories for	370019		
	No.	371220	Ref. No. —
	reducer TP flow rate 3l/min red tolerance ±15%		
	No.	371221	Ref. No. —
	reducer TP flow rate 5.5l/min yellow tolerance ±15%		
	No.	371222	Ref. No. —
	reducer TP flow rate 6l/min grey tolerance ±15%		
	No.	371223	Ref. No. —
	reducer TP flow rate 10l/min white tolerance ±15%		
	No.	371224	Ref. No. —
	reducer TP flow rate 12l/min bronze tolerance ±15%		
	No.	371225	Ref. No. —
	reducer TP flow rate 16l/min light brown tolerance ±15%		
	No.	371226	Ref. No. —
	reducer TP flow rate 20l/min red tolerance ±15%		
	No.	371230	Ref. No. —
	reducer TP flow rate 0.25l/min red tolerance ±25%		
	No.	371231	Ref. No. —
	reducer TP flow rate 0.35l/min violet tolerance ±25%		

Table continues overleaf



accessories for		370019		
No.	371232	Ref. No.	—	
	reducer TP flow rate 0.5l/min orange tolerance $\pm 25\%$			
No.	371233	Ref. No.	—	
	reducer TP flow rate 0.8l/min white tolerance $\pm 25\%$			
No.	371234	Ref. No.	—	
	reducer TP flow rate 1l/min light blue tolerance $\pm 25\%$			
No.	371235	Ref. No.	—	
	reducer TP flow rate 1.2l/min brown tolerance $\pm 25\%$			
No.	371236	Ref. No.	—	
	reducer TP flow rate 1.5l/min light brown tolerance $\pm 25\%$			
No.	371237	Ref. No.	—	
	reducer TP flow rate 2.5l/min yellow tolerance $\pm 25\%$			
No.	371238	Ref. No.	—	
	reducer TP flow rate 3.4l/min dark green tolerance $\pm 25\%$			
No.	371239	Ref. No.	—	
	reducer TP flow rate 5l/min black tolerance $\pm 25\%$			
No.	371240	Ref. No.	—	
	reducer TP flow rate 8l/min blue tolerance $\pm 20\%$			

solenoid valves with reducers

				
1				
No.	370401	Ref. No.	RF000624	
description	solenoid valve single angled 230VAC inlet 3/4" outlet 11.5mm output 2.5l/min t.max. 90°C TP plastic flow regulating valve outlet yellow			

solenoid valves (refrigeration)

CASTEL







valves

				
1				
No.	370567	Ref. No.	RF000532	
description	solenoid valve angled type 1018/M617A6 230V p max 35bar connection 6mm soldering connection -35 up to 110°C CASTEL 50/60Hz cable length 600mm			

valve bodies

STANDARD series

suitable for refrigerants R22, R134a, R404A, R407C, R410A, R507

				
1				
No.	370151	Ref. No.	RF000557	
description	solenoid valve body NC type 1028/2 S p max 45bar connection 1/4" soldering connection DN 2.2mm -35 up to +105°C L 125mm refrigeration straight CASTEL			
accessories for	370151			
	No.	371084	Ref. No.	—
	solenoid coil CASTEL 230VAC 8VA 50/60Hz connection cable 1000mm type CM2			
	No.	371090	Ref. No.	—
	power socket plug type DIN 43650A screw			
	No.	371301	Ref. No.	—
	solenoid coil CASTEL 110VAC 8VA 50/60Hz seat \varnothing 11.5mm connection DIN 43650A type HF2			
	No.	371314	Ref. No.	—
	solenoid coil CASTEL 240VAC 8VA 50/60Hz seat \varnothing 11.5mm			
	No.	371321	Ref. No.	—
	solenoid coil CASTEL 12/24VAC 50/60Hz seat \varnothing 11.5mm connection DIN 43650A type HF2			

CEME

valves

with pipe clamp

				
1				
No.	370408	Ref. No.	RF00B770	
description	solenoid valve straight CEME type 6807 230V pressure range 0.1-25bar DN2.5 connection 6mm soldering connection -45 up to +125°C refrigeration			



various

valves



1

No.	370406	Ref. No.	RF000531 RF000532
description	solenoid valve angled type 5925 p max 25bar DN1.5 connection 6mm soldering connection -45 up to +125°C CEME refrigeration 230V		



1

No.	370407	Ref. No.	RF000532
description	solenoid valve angled type 5925 pressure range 0.1-25bar DN2.0 connection 6mm soldering connection -45 up to +125°C CEME refrigeration 230V		

pressure switches

for refrigeration

SAGI NO MIYA



1

No.	541120	Ref. No.	RF000621
description	pressure control HD reset automatic refrigeration type HTB-X3028 connection male faston 6.3mm switch-on pressure 17bar		

compressors

ACC/ZEL

R404a/R507

HMBP monophase

High/Medium evaporation temperature above -20/-15 °C



1

No.	605020	Ref. No.	RB00A795
description	compressor coolant R404a/R507 type ML40TB 220-240V 50Hz HMBP fully hermetic 10kg 1/6HP cylinder capacity 4.04cm³ CSIR H 175.5mmW 168W 218W 276W 342W 416W 499W 589W 688W test method ASHRAE		



1

No.	605074	Ref. No.	RB00B369
description	compressor coolant R404a/R507 type ML60TG 220-240V 50Hz HMBP fully hermetic 10kg 1/4HP cylinder capacity 5.7cm³ CSIR H 191.1mmW 218W 286W 365W 457W 562W 678W 807W 947W test method ASHRAE		



1

No.	605014	Ref. No.	RB00A797
description	compressor coolant R404a/R507 type ML80TB 220-240V 50Hz HMBP fully hermetic 11.4kg 3/8HP cylinder capacity 7.57cm³ CSIR H 175.5mmW 261W 346W 446W 561W 691W 835W 993W 1167W test method ASHRAE ambient temperature max. 43°C		



1

No.	605028	Ref. No.	RB00A798
description	compressor coolant R404a/R507 type ML90TB 220-240V 50Hz HMBP fully hermetic 11.6kg 3/8HP cylinder capacity 8.85cm ³ CSIR H 175.5mmW 323W 418W 532W 666W 819W 990W 1181W 1391W test method ASHRAE ambient temperature max. 43°C		

EMBRACO / ASPERA
R404a/R507
HMBP monophase
High/Medium evaporation temperature above -20/-15 °C



1

No.	605030	Ref. No.	RB00B162
description	compressor coolant R404a/R507 type NJ9226GK 220-240V 50Hz HMBP fully hermetic 20.8kg 1HP cylinder capacity 21.7cm ³ CSIR H 265mmW 1363W 1764W 2249W 2819W 3472W 4210W 5032W test method ASHRAE		

CUBIGEL
R404a/R507
HMBP monophase
High/Medium evaporation temperature above -20/-15 °C



1

No.	605013	Ref. No.	RB00A796 RB00B369
description	compressor coolant R404a/R507 type ML60TB 220-240V 50Hz HMBP fully hermetic 10.1kg 1/4HP power input 647W cylinder capacity 5.68cm ³ CSIR H 175.5mmW 244W 319W 407W 511W 628W 760W 906W 1067W test method ASHRAE		

L'UNITE HERMETIQUE / TECUMSEH
R404A
HMBP monophase
High/Medium evaporation temperature above -20/-15 °C



1

No.	605025	Ref. No.	RB00B620
description	compressor coolant R404A type AE4430Z-FZ 220-240V 50Hz HMBP fully hermetic 10.2kg 1/4HP power input 427W cylinder capacity 5.7cm ³ CSIR H 186mmWW 258W 346W 441W 550W 682W 794W test method EN 12900 908W		
spare parts for	605025		
	No.	Ref. No.	—
	start relay MTRP0027-31 120/240V voltage AC 8A 1NO		



1

No.	605029	Ref. No.	RB00B149
description	compressor coolant R404a/R507 type MP12RB 220-240V 50Hz HMBP fully hermetic 13.5kg 1/2HP cylinder capacity 12cm ³ CSIR H 203.6mmW 561W 734W 933W 1157W 1407W 1681W 1982WW test method ASHRAE ambient temperature max. 43°C		



1

No.	605021	Ref. No.	RB00B133
description	compressor coolant R404A type AEZ4425Z 220-240V 50Hz HMBP fully hermetic 9.8kg 1/5HP cylinder capacity 4.5cm ³ CSIR H 186mmWW 198W 263W 341W 432W 537W 629W test method EN 12900 723W		



1

No.	605022	Ref. No.	RB000440
description	compressor coolant R404A type AEZ4440Z 230V 50Hz HMBP fully hermetic 21kg cylinder capacity 7.55cm ³ CSIR H 292mm 415W 517W 637W 772W 919W 1074W test method EN 12900 1234W		

fans

refrigeration fans

refrigeration motors universal

ebm-papst

miscellaneous



1

No.	601405	Ref. No.	RC000451 RD00B934
description	fan motor M4Q045-CA01-19 7W 230V 50Hz W 83mm		
spare parts for	601405		
	No.	601413	Ref. No. —
	fixing plate suitable for fanwheel ED ø 32mm shaft ø 7 mounting distance 26mm		

ELCO

N series - multi fit



1

No.	601427	Ref. No.	RC000452
description	fan motor ELCO 10W 230V 50/60Hz bearing slide bearing L1 49mm L2 59mm L3 86.5mm W 83mm connection cable 500mm 1300/1550rpm 5 mounting options VNT10-20/028		
spare parts for	601427		
	No.	560140	Ref. No. —
	hexagonal nut thread M4 H 4.8mm SS WS 7 Qty 20 pcs DIN/ISO DIN 985 self-locking		
	No.	560332	Ref. No. —
	plain washer ID ø 4.3mm ED ø 9mm thickness 0.8mm SS Qty 1 pcs		
	No.	560340	Ref. No. —
	hexagonal nut thread M4 H 3.2mm WS 7 SS DIN/ISO DIN 934 / ISO 4032/8673 Qty 1 pcs		
	No.	601413	Ref. No. —
	fixing plate suitable for fanwheel ED ø 32mm shaft ø 7 mounting distance 26mm		

N series - standard



1

No.	601527	Ref. No.	RC00A807
description	fan motor 16W 230V 50/60Hz W 84mm 1300rpm VN16-38		

IMPORT

multi fit fan motors



1			
No.	601022	Ref. No.	RD000512
description	fan motor 10W 230V 50-60Hz L1 44mm L2 54mm L3 85mm W 84mm cable length 500mm 1300rpm YZF10-20-18/26 5 mounting options bearing slide bearing		



1			
No.	601023	Ref. No.	RD000513
description	fan motor 16W 230V 50-60Hz L1 45mm L2 61mm L3 92mm W 84mm cable length 500mm 1300rpm YZF16-25-18/26 5 mounting options bearing slide bearing		



1			
No.	601020	Ref. No.	RD000511
description	fan motor 5W 230V 50-60Hz L1 44mm L2 48mm L3 79mm W 84mm cable length 500mm 1300rpm YZF5-13-18/26 5 mounting options bearing slide bearing		

accessories

fan wheels

aluminium

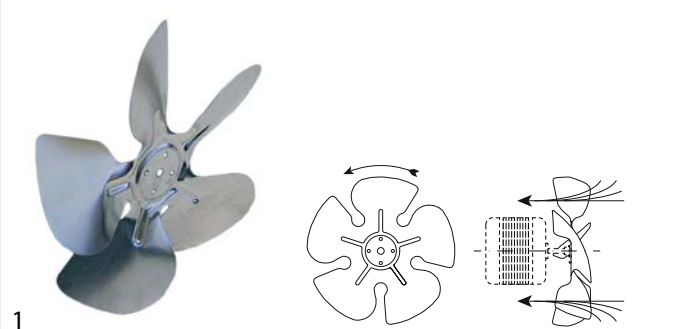

1			
No.	601069	Ref. No.	RD000518
description	fan wheel sucking ø 172mm turn direction left fan wheel mounting 25.4mm blade angle 25° W 32mm aluminium		

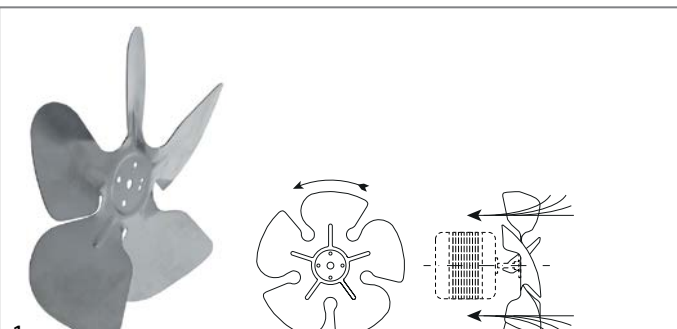

1			
No.	601070	Ref. No.	RD000519
description	fan wheel sucking ø 200mm fan wheel mounting 25.4mm blade angle 28° W 38mm aluminium		

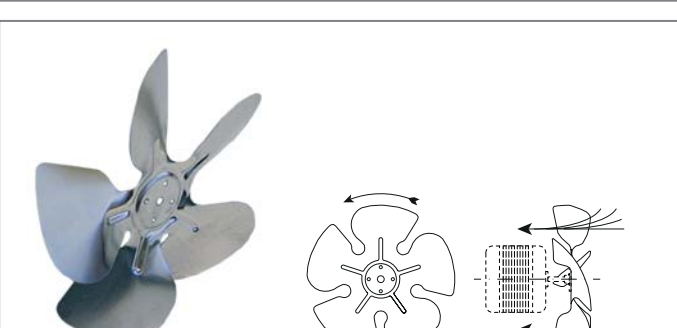

1			
No.	601071	Ref. No.	RD000520
description	fan wheel sucking ø 230mm fan wheel mounting 25.4mm blade angle 25° W 37mm aluminium		

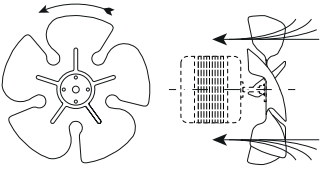

1

No.	601409	Ref. No.	RD000521 RD00A629
description	fan wheel sucking ø 254mm fan wheel mounting 25.4mm blade angle 25° W 38mm aluminium		

1

No.	601079	Ref. No.	RD000509
description	fan sucking 230V 18W 50Hz fan wheel ø 130mm shaft L 20mm feet depth 31mm connection right		

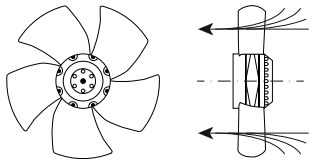
1

No.	601410	Ref. No.	RD000499
description	fan wheel sucking ø 300mm fan wheel mounting 25.4mm blade angle 28° W 45mm aluminium		

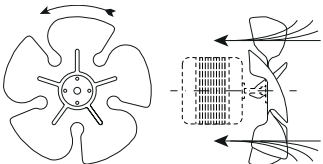
miscellaneous

1



No.	601411	Ref. No.	RD000508
description	fan 230V		

cold air circulating fans (complete)

COPREL

AX series

1

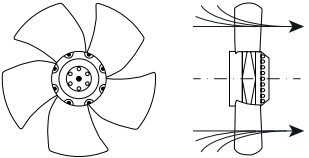
No.	601078	Ref. No.	RD000508 RD000510
description	fan blowing 230V 18W 50Hz fan wheel ø 130mm shaft L 21mm feet depth 29mm connection left		
spare parts for	601078		
	No.	510923	Ref. No. —
clamping ring for shaft ø 10mm ID ø 9.4mm H 6mm			

motors

gear motors

for ice-cube maker

for paddles

1



No.	500407	Ref. No.	RG000636 RG636
description	gear motor LIP type 123MR 8W 220/240V voltage AC 50/60Hz 50rpm turn direction counterclockwise shaft ø 4mm shaft intake ø 6.2mm groove width 2.3mm shaft L 8mm shaft ø 4mm W 74mm		



for sumps



1	No.	500412	Ref. No.	RG000640
description	gear motor LIP type 021B 11W 230V 50Hz 1rpm shaft ø 7mm shaft length 20mm W 74mm D 67mm H 110mm for sump			



1	No.	500688	Ref. No.	RG000640 RG00A684
description	gear motor LIP type 068 11W 230V voltage AC 50Hz 1rpm shaft ø 7mm shaft length 20mm W 75mm D 80mm H 110mm for sump shaft with transverse hole			

miscellaneous



1	No.	500788	Ref. No.	RG000650
description	gear motor 230V			

motors

for ice-cube maker

complete



1	No.	500787	Ref. No.	RG000647
description	motor 180W 230V 50/60Hz 1 phase shaft ø 12.8mm 1300rpm RPM 0.18kW			

electric accessories

terminals

connection terminals with screw/faston connections



1	No.	550411	Ref. No.	RI000709
description	power terminal block 6-pole max. 40A max 450V connection ø6mm ² / F6.3 temp.-resist. 150°C cross section 6mm ²			

equipment-specific units

for ice-cube maker

ice chutes

slide grates



1	No.	692097	Ref. No.	RN00A017 RNA017
description	slide grate for ice-cube maker L 160mm W 170mm H 60mm			

gearboxes

1	No.	695383	Ref. No.	RG000649
description	gearbox			





1

No.	695382	Ref. No.	RG000646
description	gearbox H 140mm L 160mm W 150mm shaft L 23mm drive shaft ø 11.5mm		

doors

doors



1

No.	698942	Ref. No.	RP00A667
description	door W 378mm H 245mm plastic		

pan mechanics

sumps



1

No.	695358	Ref. No.	RH00A004
description	sump for ice maker L 180mm W 140mm H 60mm EUROFRIGOR white		



1

No.	695359	Ref. No.	RH00A005 RHA005
description	sump for ice maker L 180mm W 180mm H 60mm EUROFRIGOR		



1

No.	695360	Ref. No.	RH00A006
description	sump for ice maker L 180mm W 245mm H 60mm EUROFRIGOR white		



1

No.	695361	Ref. No.	RM00A050
description	sump for ice maker L 330mm W 195mm H 60mm		



1

No.	695362	Ref. No.	RM00A079
description	sump for ice maker L 465mm W 200mm H 70mm		



1

No.	695363	Ref. No.	RM00A047
description	sump for ice maker L 690mm W 200mm H 70mm		

spare parts and accessories



1

No.	695376	Ref. No.	RQ001152
description	adjusting ring for spindle H 7mm ID ø 6mm ED ø 12mm thread M4 stainless steel		

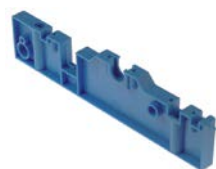

1

No.	695364	Ref. No.	RH003616
description	bracket for sump		



1

No.	695365	Ref. No.	RQ003619
description	bush for impulse		

1			
No.	695367	Ref. No.	RH003618
description	lever for pan tilting		

1			
No.	695030	Ref. No.	RH00A008
description	lever for pan tilting new edition EUROFRIGOR		

1			
No.	695031	Ref. No.	RH00669 RM1063
description	lever for pan tilting old edition EUROFRIGOR		

1			
No.	695032	Ref. No.	RH000675 RH675
description	paddle short ø 135mm shaft intake ø 6mm shaft lengthmm 1		

1			
No.	695368	Ref. No.	RQ003626
description	pin for pan tilting		

1			
No.	695369	Ref. No.	RQ003625
description	spindle for ice maker ø 6mm L 160mm		

1			
No.	695370	Ref. No.	RQ00A028
description	spindle for ice maker ø 6mm L 195mm		

1			
No.	695371	Ref. No.	RQ00A029
description	spindle for ice maker ø 6mm L 235mm		

1			
No.	695378	Ref. No.	RQ000976
description	spindle for ice maker ø 6mm L 235mm		

1			
No.	695372	Ref. No.	RQ00A030
description	spindle for ice maker ø 6mm L 300mm		

1			
No.	695373	Ref. No.	RQ00A062
description	spindle for ice maker ø 6mm L 380mm		

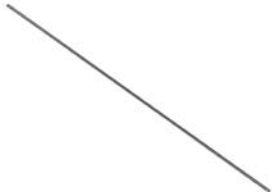
1			
No.	695374	Ref. No.	RQ00A075
description	spindle for ice maker ø 6mm L 517mm		

1			
No.	695375	Ref. No.	RQ00A063
description	spindle for ice maker ø 6mm L 742mm		

1			
No.	695028	Ref. No.	RQ00A064
description	spindle for pan tilting		



1 			
No.	695029	Ref. No.	RQ00A065
description	spindle for pan tilting ø 6mm length external size 31mm L 26mm EUROFRIGOR		

1 			
No.	695366	Ref. No.	RH003620
description	wheel for pan tilting ø 100mm		

drive technology

1 			
No.	695384	Ref. No.	RV003202
description	toothed belt disc disc ø 38mm shaft intake ø 13mm groove depth 5mm disc width 13mm groove width 10x10mm overall width 22mm splitting 5 shaft ø 23.5mm		

1			
No.	695386	Ref. No.	RV003201
description	toothed belt disc large type ES40-100		

mechanics for evaporators

gear motors

motors

1 			
No.	500787	Ref. No.	RG000647
description	motor 180W 230V 50/60HzHz 1 phase shaft ø 12.8mm 1300rpm RPM 0.18kW		

hoses

formed hoses

straight

silicone hoses

1 			
No.	530879	Ref. No.	913037210
description	drain hose straight ID ø 19mm ED ø 24mm L 210mm		

hose connectors

without thread

1 			
No.	695055	Ref. No.	RH003285+A716+B267
description	hose connector		

1 			
No.	695054	Ref. No.	RH000665
description	hose connector for ice-cube maker		

1 			
No.	695056	Ref. No.	RH003286+A716+B267
description	hose connector for ice-cube maker		

1 			
No.	695057	Ref. No.	RH001080
description	hose connector hose ø 12mm L 100mm L-shape plastic		

floats

float containers

1 			
No.	695070	Ref. No.	RH000828
description	float container		



1

No.	695073	Ref. No.	RH00B632
description	float container		
spare parts for	695073		
	No.	346872	Ref. No.
			RI000800
description	microswitch with lever 250V 0.1A 1CO connection male faston 6.3mm L 50mm ambient temperature max. 85°C mounting distance 22mm type D41X actuating force: 6g lever length 36mm		

for ice crusher

V-belts



1

No.	695387	Ref. No.	RV00A296
description	V-belt pulley single disc ø 128mm shaft intake ø 14mm groove depth 14mm disc width 19mm groove width 4mm overall width 35mm aluminium		

refrigeration cycle components

filter driers

miscellaneous



1

No.	750226	Ref. No.	RF000546
description	dryer size 20g ø 24mm L 117mm connection 6.2/6.3mm		

transmission technology and ball bearings

drive belts

toothed belts



1

No.	695388	Ref. No.	RV003233 RV00B075
description	toothed belt profile XL L 196mm H 2mm teeth 98 splitting rubber with textile insertion CODE 196XL W 10mm type BI 4 164		

springs

compression springs



1

No.	695034	Ref. No.	RR003629
description	compression spring ø 10mm L 35mm wire gauge ø 1.7mm		

hoses

drain hoses



1

No.	530726	Ref. No.	RH001181
description	drain hose DN19 L 1530mm A int. ø 19mm A ext. ø 23mm B int. ø 22mm B ext. ø 28mm outer hose ø 24mm		

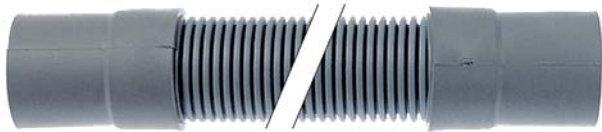

1

No.	530724	Ref. No.	RH001180
description	drain hose DN19 L 180mm A int. ø 19mm A ext. ø 27mm B int. ø 19mm B ext. ø 27mm outer hose ø 24mm		



1

No.	530727	Ref. No.	RH001177
description	drain hose DN19 L 280mm A int. ø 19mm A ext. ø 27mm B int. ø 19mm B ext. ø 27mm outer hose ø 24mm		



1

No.	530725	Ref. No.	RH001176
description	drain hose L 210mm A int. ø 19mm B int. ø 19mm outer hose ø 24mm		



1

No.	530728	Ref. No.	RH001182
description	drain hose L 270mm A int. ø 19mm A ext. ø 27mm B int. ø 19mm B ext. ø 27mm outer hose ø 24mm		

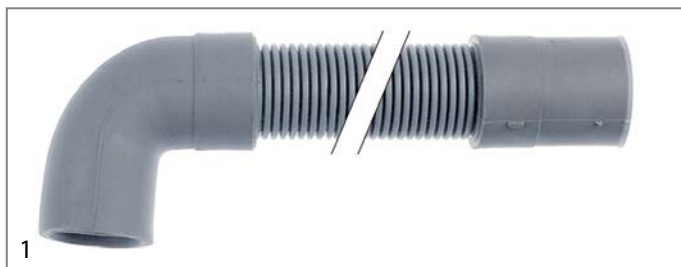

1	No.	530722	Ref. No.	RH001175
description	drain hose DN19 L 180mm straight ø inside 19mm straight ext. ø 25mm elbow ø inside 21mm elbow ext. ø 27mm outer hose ø 24mm			

fastening material

fasteners

retaining rings

DIN 6799



1	No.	528709	Ref. No.	RR3644
description	retaining ring E D1 ø 4mm D2 ø 9mm steel DIN 6799 thickness 0.7mm for shaft ø 5-7mm			