

# Professionall

Solutii profesionale pentru echipamente profesionale



**GAS COMPONENTS**



**ELECTRIC COMPONENTS**



**WATER TECHNOLOGY**



**MECHANICAL COMPONENTS**



**TOOLS**

Spare parts suitable for

# FRANKE



## heating elements

### heating elements for chip scuttles

			
<b>No.</b>	418465	<b>Ref. No.</b>	178980 1G592028
<b>description</b>	heating element 800W 230V heating circuits 1 L 370mm W 95mm connection male faston 6.3mm tube ø 6.3mm dry heating element connection distance 89mm		

### heating elements for fryers

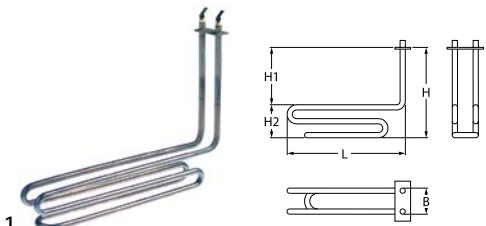
			
<b>No.</b>	418460	<b>Ref. No.</b>	178613 1G592018
<b>description</b>	heating element 2000W 230V heating circuits 1 L 280mm W 42mm H 200mm rectangular flange connection male faston 6.3mm H1 146mm H2 54mm hole ø 5mm flange length 48mm flange width 18mm fryer		

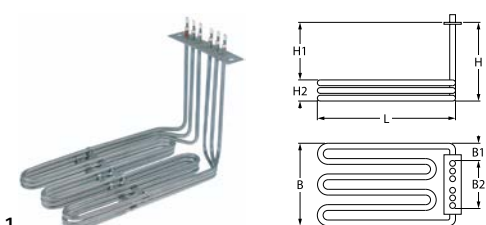
			
<b>No.</b>	418474	<b>Ref. No.</b>	1G564035
<b>description</b>	heating element 6000W 230/400V heating circuits 3 L 285mm W 155mm H 173mm rectangular flange connection male faston 6.3mm immersion heater W1 32.5mm W2 90mm H1 151mm H2 22mm hole distance 124mm hole ø 8mm flange length 136mm flange width 30mm tube ø 6.5mm connection length 33mm		

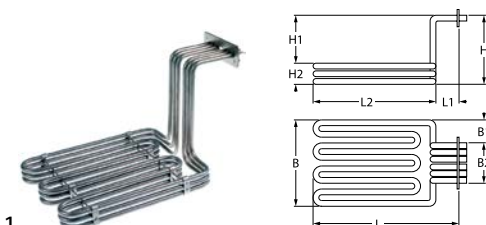
			
<b>No.</b>	418461	<b>Ref. No.</b>	178871
<b>description</b>	heating element 6000W 230/400V heating circuits 3 L 357mm W 208mm H 210mm L1 77mm L2 283mm W1 67mm W2 74mm H1 178mm H2 32mm windings 9 flange length 100mm flange width 40mm hole distance 83mm connection male faston 6.3mm mounting thread M5 tube ø 8.5mm rectangular flange immersion heater		

### heating elements for griddles

			
<b>No.</b>	418575	<b>Ref. No.</b>	1V421471
<b>description</b>	heating element 100W 230V heating circuits 1 L 94mm W 68mm tube ø 6.5mm cable length 70mm connection length 20mm dry heating element		

			
<b>No.</b>	418463	<b>Ref. No.</b>	1G563025
<b>description</b>	heating element 3300W 400V heating circuits 1 L 420mm W 255mm H 45mm tube ø 6.5mm cable length 450mm connection length 23mm connection distance 249mm dry heating element		

			
<b>No.</b>	418435	<b>Ref. No.</b>	178859 1G870069
<b>description</b>	heating element 3500W 230V heating circuits 1 L 460mm W 233mm H 73mm tube ø 6.3mm cable length 1050mm connection length 25mm griddle dry heating element		

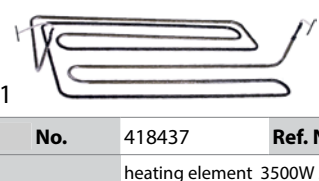
			
<b>No.</b>	418437	<b>Ref. No.</b>	178996
<b>description</b>	heating element 3500W 380V heating circuits 1 L 478mm W 250mm H 70mm tube ø 6.3mm cable length 115mm mounting pos. right griddle dry heating element		

			
<b>No.</b>	418434	<b>Ref. No.</b>	178993 1G870133
<b>description</b>	heating element 3500W 380V heating circuits 1 L 480mm W 310mm H 70mm tube ø 6.5mm cable length 550mm connection length 35mm griddle dry heating element		

electric components





			
1	<b>No.</b>	418406	<b>Ref. No.</b>
			178857
<b>description</b>	heating element 3500W 400V heating circuits 1 L 455mm W 287mm H 77mm tube ø 6.5mm cable length 1100mm dry heating element		

			
1	<b>No.</b>	418436	<b>Ref. No.</b>
			BK178995
<b>description</b>	heating element 3500W 400V heating circuits 1 L 480mm W 250mm H 70mm tube ø 6.5mm cable length 115mm mounting pos. left griddle dry heating element		

## heating elements for large hobs

			
1	<b>No.</b>	418485	<b>Ref. No.</b>
			1G532081
<b>description</b>	heating element 1100W 400V L 258mm W 258mm H 82mm heating circuits 1 tube ø 6.5mm mounting pos. centre/inside connection length 20mm connection M4 dry heating element		

			
1	<b>No.</b>	418484	<b>Ref. No.</b>
			1G532080
<b>description</b>	heating element 1300W 400V L 284mm W 284mm H 81mm heating circuits 1 tube ø 6.5mm mounting pos. centre/outside connection length 20mm connection M4 dry heating element		

			
1	<b>No.</b>	418483	<b>Ref. No.</b>
			1G532079
<b>description</b>	heating element 650W 400V L 315mm W 315mm H 80mm heating circuits 1 tube ø 6.5mm mounting pos. outer connection length 20mm connection M4 dry heating element		

			
1	<b>No.</b>	418486	<b>Ref. No.</b>
			1G532082
<b>description</b>	heating element 900W 400V L 230mm W 230mm H 81mm heating circuits 1 tube ø 6.5mm mounting pos. inner connection length 20mm connection M4 dry heating element		

## heating elements for salamanders/toast-

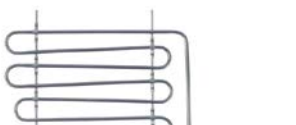
			
1	<b>No.</b>	419184	<b>Ref. No.</b>
			409100
<b>description</b>	heating element 2000W 230V heating circuits 1 L 205mm W 262mm W2 305mm flange length 26mm flange width 11mm tube ø 4mm connection length 36mm dry heating element connection F6.3 salamander grill H 4mm		

			
1	<b>No.</b>	415541	<b>Ref. No.</b>
			279801
<b>description</b>	heating element 2000W 230V heating circuits 1 mounting pos. left L 250mm W 210mm H 120mm W2 170mm connection distance 164mm tube ø 6.3mm cable length 500mm dry heating element salamander grill		

			
1	<b>No.</b>	415540	<b>Ref. No.</b>
			279802
<b>description</b>	heating element 2000W 230V heating circuits 1 mounting pos. right L 250mm W 210mm H 120mm W2 170mm connection distance 164mm tube ø 6.5mm cable length 500mm dry heating element salamander grill		



bottom heaters





1

<b>No.</b>	390410	<b>Ref. No.</b>	1G963100
<b>description</b>	bi-metal safety thermostat hole distance 24mm switch-off temp. 200°C 1NC 1-pole 16A connection F6.3 2 hole fixing		



1

<b>No.</b>	418429	<b>Ref. No.</b>	1G564207	
<b>description</b>	bottom heater 1800W 230V heating circuits 1 ø 196mm safety thermostat 250°C M5 mounting distance 180mm			
<b>spare parts for</b>	418429			
	<b>No.</b>	375137	<b>Ref. No.</b>	—
	safety thermostat switch-off temp. 250°C 1-pole 16A probe ø 3.03mm probe L 160mm capillary pipe 880mm capillary pipe isolated 800mm gland nut probe SS with curved probe			





1

<b>No.</b>	418473	<b>Ref. No.</b>	1G963111
<b>description</b>	bottom heater 1800W 230V heating circuits 1 ø 196mm safety thermostat 250°C M5 mounting distance 180mm		





1

<b>No.</b>	418466	<b>Ref. No.</b>	1G963110	
<b>description</b>	bottom heater 1800W 230V heating circuits 1 ø 196mm thermostat 128°C M5 mounting distance 180mm			
<b>spare parts for</b>	418466			
	<b>No.</b>	375782	<b>Ref. No.</b>	—
	thermostat t.max. 128°C temperature range 30-128°C 1-pole 1NO 16A probe ø 3.03mm probe L 178mm capillary pipe 870mm capillary pipe isolated 800mm gland nut shaft ømm shaft L 23mm shaft position upper rotation 270° outer switch 2NO with curved probe			
	<b>No.</b>	520323	<b>Ref. No.</b>	—
	gasket ID ø 160mm ED ø 200mm hole distance 90/180mm hole ø 7mm silicone for bottom heaters			

<b>accessories for</b>	418466			
	<b>No.</b>	520323	<b>Ref. No.</b>	—
	gasket ID ø 160mm ED ø 200mm hole distance 90/180mm hole ø 7mm silicone for bottom heaters			





1

<b>No.</b>	418467	<b>Ref. No.</b>	1G564199	
<b>description</b>	bottom heater 1800W 230V heating circuits 2 ø 196mm safety thermostat 250°C thermostat 105°C M5 mounting distance 180mm			
<b>spare parts for</b>	418467			
	<b>No.</b>	375137	<b>Ref. No.</b>	—
	safety thermostat switch-off temp. 250°C 1-pole 16A probe ø 3.03mm probe L 160mm capillary pipe 880mm capillary pipe isolated 800mm gland nut probe SS with curved probe			
	<b>No.</b>	375794	<b>Ref. No.</b>	—
	thermostat t.max. 105°C temperature range 30-105°C 1-pole 1NO 16A probe ø 3.03mm probe L 178mm capillary pipe 870mm capillary pipe isolated 800mm gland nut shaft ø6x4.6mm shaft L 23mm shaft position upper rotation 270° outer switch 2NO with curved probe			
<b>accessories for</b>	418467			
	<b>No.</b>	520323	<b>Ref. No.</b>	—
	gasket ID ø 160mm ED ø 200mm hole distance 90/180mm hole ø 7mm silicone for bottom heaters			



1



<b>No.</b>	418482	<b>Ref. No.</b>	1G564209	
<b>description</b>	bottom heater 2000W 400V heating circuits 1 ø 196mm safety thermostat 250°C thermostat 128°C M5 H 5mm mounting distance 180mm connection male faston 6.3mm			
<b>spare parts for</b>	418482			
	<b>No.</b>	375137	<b>Ref. No.</b>	—
	safety thermostat switch-off temp. 250°C 1-pole 16A probe ø 3.03mm probe L 160mm capillary pipe 880mm capillary pipe isolated 800mm gland nut probe SS with curved probe			
	<b>No.</b>	375782	<b>Ref. No.</b>	—
	thermostat t.max. 128°C temperature range 30-128°C 1-pole 1NO 16A probe ø 3.03mm probe L 178mm capillary pipe 870mm capillary pipe isolated 800mm gland nut shaft ømm shaft L 23mm shaft position upper rotation 270° outer switch 2NO with curved probe			



E-G-O



1

<b>No.</b>	419008	<b>Ref. No.</b>	1G564319 834963
<b>description</b>	bottom heater 3000W 400V heating circuits 2 ø 196mm safety thermostat 250°C thermostat 128°C M5 H 180mm		
<b>spare parts for</b>	419008		
	<b>No.</b>	375137	<b>Ref. No.</b> —
	safety thermostat switch-off temp. 250°C 1-pole 16A probe ø 3.03mm probe L 160mm capillary pipe 880mm capillary pipe isolated 800mm gland nut probe SS with curved probe		
	<b>No.</b>	375782	<b>Ref. No.</b> —
	thermostat t.max. 128°C temperature range 30-128°C 1-pole 1NO 16A probe ø 3.03mm probe L 178mm capillary pipe 870mm capillary pipe isolated 800mm gland nut shaft ømm shaft L 23mm shaft position upper rotation 270° outer switch 2NO with curved probe		

## heating plates







1

<b>No.</b>	418438	<b>Ref. No.</b>	BK178987
<b>description</b>	hot plate 700W 230V heating circuits 1 cable length 750mm L 480mm W 80mm		

## heating elements for convection



1

<b>No.</b>	418690	<b>Ref. No.</b>	10295641
<b>description</b>	heating element 2000W 230V L 90mm W 390mm connection F 6.3 tube ø 8.5mm M14x1.5 mounting distance 390mm		
<b>accessories for</b>	418690		
	<b>No.</b>	510417	<b>Ref. No.</b> —
	flat gasket fibre ED ø 20mm ID ø 14mm thickness 2mm Qty 1 pcs		
	<b>No.</b>	520228	<b>Ref. No.</b> —
	tooth lock washer ID ø 15.3mm ED ø 24mm steel Qty 1 pcs for thread M14		
	<b>No.</b>	520230	<b>Ref. No.</b> —
	nut thread M14x1.5 H 5mm WS 19 zinc-coated steel Qty 1 pcs		
	<b>No.</b>	521101	<b>Ref. No.</b> —
	nut thread M14x1.5 H 5mm WS 19 SS Qty 1 pcs		
	<b>No.</b>	550262	<b>Ref. No.</b> —
	flat gasket copper ED ø 20mm ID ø 14mm thickness 2mm		

## radiation heaters



1

<b>No.</b>	490148	<b>Ref. No.</b>	1G962926
<b>description</b>	radiation heater rectangular 2500W 400V without pan detection L 300mm W 570mm heating circuits 2 EGO		



1

<b>No.</b>	490147	<b>Ref. No.</b>	1G962922
<b>description</b>	radiation heater rectangular 3500W 230V with pan detection L 300mm W 570mm heating circuits 2 EGO		



1

<b>No.</b>	490198	<b>Ref. No.</b>	409.101
<b>description</b>	radiation heater rectangular flange 2300W 230V L 320mm W 230mm H 35mm heating circuits 1 EGO		

## 1-circuit



1

<b>No.</b>	490131	<b>Ref. No.</b>	1G962948
<b>description</b>	radiation heater ø 250mm 2500W 400V heating circuits 1 energy regulation with temperature signalization with ribbon heater connections 2+2 connection type male faston 6.3mm EGO		

## foil heating elements



1

<b>No.</b>	418472	<b>Ref. No.</b>	1G962947
<b>description</b>	foil heating element L 400mm W 230mm 175W 230V aluminium cable length 490mm thickness 3mm		



## energy regulators

### EGO

#### 1-circuit



1

<b>No.</b>	380015	<b>Ref. No.</b>	962529
<b>description</b>	energy regulator 230V 13A single-circuit turn direction right shaft ø 6x4.6mm shaft L 23mm mounting thread M4 power release 6-100% no. 50.57021.010		

## thermostats

### bi-metal thermostats

#### safety bi-metal thermostats



1

<b>No.</b>	390410	<b>Ref. No.</b>	1G963100
<b>description</b>	bi-metal safety thermostat hole distance 24mm switch-off temp. 200°C 1NC 1-pole 16A connection F6.3 2 hole fixing		

#### bi-metal thermostats



1

<b>No.</b>	390592	<b>Ref. No.</b>	1V421472
<b>description</b>	bi-metal thermostat hole distance 24mm switch-off temp. 100°C 1NC 1-pole 2 hole fixing		

## control and safety thermostats



### EGO

#### control thermostats

#### 55.13\_ series



1

<b>No.</b>	375007	<b>Ref. No.</b>	178983	
<b>description</b>	thermostat t.max. 110°C temperature range 30-110°C 1-pole 1NO 16A probe ø 6mm probe L 113mm capillary pipe 870mm capillary pipe isolatedmm gland nut M9x1 shaft L 25mm shaft position upper rotation 270°			
<b>accessories for</b>	375007			
	<b>No.</b>	110119	<b>Ref. No.</b>	—
	knob thermostat t.max. 110°C ø 50mm shaft ø 6x4.6mm shaft flat upper black temperature range 30-110°C rotation 270°			
	<b>No.</b>	110241	<b>Ref. No.</b>	—
	knob thermostat t.max. 110°C ø 50mm shaft ø 6x4.6mm shaft flat upper black temperature range 30-110°C			

#### safety thermostats

#### 55.11\_ series



1

<b>No.</b>	375790	<b>Ref. No.</b>	178882 BK178610
<b>description</b>	safety thermostat switch-off temp. 273°C 1-pole 16A probe ø 6mm probe L 77mm capillary pipe 400mm capillary pipe isolatedmm gland nut probe SS		

55.13\_series



<b>No.</b>	375784	<b>Ref. No.</b>	178982
<b>description</b>	safety thermostat switch-off temp. 140°C 1-pole 16A probe ø 6mm probe L 77mm capillary pipe 870mm capillary pipe isolated 790mm gland nut probe SS		

55.32\_series

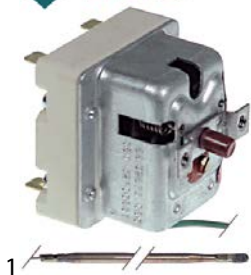

<b>No.</b>	375787	<b>Ref. No.</b>	1G962526
<b>description</b>	safety thermostat switch-off temp. 380°C 2-pole 20A probe ø 4mm probe L 163mm capillary pipe 1190mm capillary pipe isolated 800mm gland nut probe SS		

55.33\_series





<b>No.</b>	375781	<b>Ref. No.</b>	1G962532
<b>description</b>	safety thermostat switch-off temp. 275°C 3-pole 20A probe ø 4mm probe L 157mm capillary pipe 870mm capillary pipe isolated 350mm gland nut probe SS		

control thermostats with operation switch

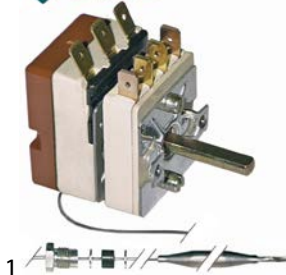
55.13\_series



<b>No.</b>	375406	<b>Ref. No.</b>	1G873027
<b>description</b>	thermostat t.max. 110°C temperature range 30-110°C 1-pole 1CO 16A probe ø 6mm probe L 113mm capillary pipe 2380mm capillary pipe isolated 1700mm gland nut M9x1 shaft ø 6x4.6mm shaft L 18mm shaft position upper rotation 270° outer switch 2NO		

<b>accessories for</b>	375406			
	<b>No.</b>	110545	<b>Ref. No.</b>	—
	knob dial plate silver thermostat t.max. 110°C 30-110°C rotation 310° ED ø 59mm ID ø 45.5mm			
	<b>No.</b>	112173	<b>Ref. No.</b>	—
	knob universal ø 62mm black without adaptor/dial plate			
	<b>No.</b>	112311	<b>Ref. No.</b>	—
	knob adapter shaft ø 6x4.6mm L 0mm with spring			

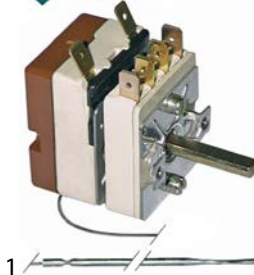

<b>No.</b>	375408	<b>Ref. No.</b>	178855 1G873056
<b>description</b>	thermostat t.max. 320°C temperature range 50-320°C 1-pole 1NO 16A probe ø 3.03mm probe L 160mm capillary pipe 1150mm capillary pipe isolatedmm gland nut shaft ø 6x4.6mm shaft L 23mm shaft position upper rotation 270° outer switch 2NO		

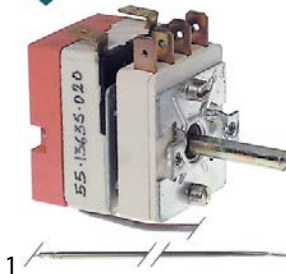

<b>No.</b>	375780	<b>Ref. No.</b>	1G962531
<b>description</b>	thermostat temperature range 120-190°C 1-pole 1NO 16A probe ø 3mm probe L 248mm capillary pipe 1730mm capillary pipe isolated 1660mm gland nut shaft ø 6x4.6mm shaft L 23mm shaft position upper rotation 270° outer switch 2NO		



55.34\_series



<b>No.</b>	375570	<b>Ref. No.</b>	179312
<b>description</b>	thermostat t.max. 470°C temperature range 100-470°C 1-pole 1NO 16A probe ø 3.9mm probe L 228mm capillary pipe 1110mm capillary pipe isolated 600mm gland nut shaft ø 6x4.6mm shaft L 24mm shaft position upper rotation 270° outer switch 2NO		



<b>No.</b>	375140	<b>Ref. No.</b>	179302
<b>description</b>	thermostat t.max. 650°C temperature range 50°C/50-600°C/70-650°C 3-pole 3NO 16A probe ø 4mm probe L 228mm capillary pipe 1200mm capillary pipe isolated 1200mm gland nut shaft ø 6x4.6mm shaft L 23mm shaft position left rotation 318° outer switch 2NO		

INVENSYS / ROBERTSHAW

control thermostats



<b>No.</b>	390636	<b>Ref. No.</b>	719.390.554
<b>description</b>	thermostat t.max. 204°C temperature range 93-204°C 1-pole 1NO 0.67A probe ø 9.5mm probe L 123mm capillary pipe 915mm capillary pipe isolatedmm gland nut 1/4" NPT shaft ø 6x4.6mm shaft L 21mm shaft position lower rotation 315° probe material nickel-plated probe thread 1/4" US		

safety thermostats



<b>No.</b>	390965	<b>Ref. No.</b>	S19.000.067
<b>description</b>	safety thermostat switch-off temp. 232°C 1-poleA probe ø 7.93mm probe L 77mm capillary pipe 760mm capillary pipe isolatedmm gland nut shaft ømm probe SS		

PRODIGY / FIRT

control thermostats



<b>No.</b>	390595	<b>Ref. No.</b>	995574
<b>description</b>	thermostat type PRODIGY temperature range 30-90°C probe ø 6.5mm probe L 63mm capillary pipe 1500mm		

switches and momentary switches

rocker/momentary rocker switches

30x22mm



<b>No.</b>	346899	<b>Ref. No.</b>	1V420303
<b>description</b>	rocker switch mounting measurements 30x22mm yellow 2NO 230V 16A illuminated 0-1 connection male faston 6.3mm ambient temperature max. 125/55°C protection IP65 with rubber collar		

push/momentary push switches

ø12mm



<b>No.</b>	346594	<b>Ref. No.</b>	1G564257
<b>description</b>	momentary push switch mounting ø 12mm black 1NO 250V 4A connection male faston 6.3mm ambient temperature max. 85°C protection IP40		





<b>No.</b>	346583	<b>Ref. No.</b>	178883
<b>description</b>	push switch mounting ø 12mm black 1NO 250V 6A connection male faston 4.8mm ambient temperature max. 100/55°C protection IP40		

microswitches

pin-plunger actuated

M10



<b>No.</b>	348013	<b>Ref. No.</b>	279-075
<b>description</b>	microswitch with plunger thread M10x0.75 thread L 20mm 250V 6A 1NO connection cable stroke 5.8mm mounting distance 22mm ambient temperature max. 125°C for door actuating force: 360g		

mercury tilt switches



<b>No.</b>	346582	<b>Ref. No.</b>	178612 1G594020
<b>description</b>	mercury tilt switch		

cam switches

on/off

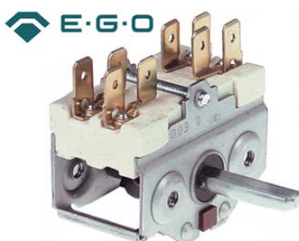

<b>No.</b>	300074	<b>Ref. No.</b>	178843 1G960702
<b>description</b>	cam switch 4 operating positions 2NO sequence 0-1-0-1 16A shaft ø 6x4.6mm shaft L 23mm connection male faston 6.3mm ceramic		

7-position



<b>No.</b>	300025	<b>Ref. No.</b>	178851	
<b>description</b>	cam switch 7 operating positions 1NO/2CO sequence 0-1-2-3-4-5-6 16A shaft ø 6x4.6mm shaft L 23mm connection screw 7-position ceramic			
<b>accessories for</b>	300025			
	<b>No.</b>	112172	<b>Ref. No.</b>	—
	knob universal ø 70mm black without adaptor/dial plate			
	<b>No.</b>	112213	<b>Ref. No.</b>	—
	knob dial plate silver switch 7-position t.max.°C ED ø 63mm ID ø 45.5mm			
	<b>No.</b>	112311	<b>Ref. No.</b>	—
	knob adapter shaft ø 6x4.6mm L 0mm with spring			

5 operating positions



<b>No.</b>	345199	<b>Ref. No.</b>	279800
<b>description</b>	cam switch 5 operating positions 2NO/1CO sequence 0-1-2-3-4 16A shaft ø 6x4.6mm shaft L 23mm connection male faston 6.3mm		



<b>No.</b>	347708	<b>Ref. No.</b>	1E409312	
<b>description</b>	cam switch shaft ø 6x4.6mm shaft L 23.5mm connection male faston 6.3mm 3-pole conversion kit			
<b>spare parts for</b>	347708			
	<b>No.</b>	301319	<b>Ref. No.</b>	—
	cam switch 16A shaft ø 6x4.6mm shaft L 23mm connection male faston 6.3mm plastic			



10 operating positions



<b>No.</b>	348183	<b>Ref. No.</b>	1G960000
<b>description</b>	cam switch 10 operating positions sequence 0-1-2-3-4-5-6-7-8-9 16A shaft ø 6x4.6mm shaft L 23mm connection male faston 6.3mm		

control equipment

SCHLEGEL

ø30.5mm



<b>No.</b>	348048	<b>Ref. No.</b>	385.230
<b>description</b>	push switch mounting measurements ø30.5 anthracite/transparent IP67 2NO sequence 0-1 with membrane		

lamps



<b>No.</b>	359896	<b>Ref. No.</b>	887026
<b>description</b>	neon light bulb socket Ba9s 230V green ø 10mm L 28mm		

lamps

indicator lights

indicator lights 3-piece (housing, lens and bulb)

ø18.2mm



<b>No.</b>	359855	<b>Ref. No.</b>	178839
<b>description</b>	indicator light housings mounting measurements ø18.2mm socket Ba9s green		

lamps

neon light bulbs



<b>No.</b>	359896	<b>Ref. No.</b>	887026
<b>description</b>	neon light bulb socket Ba9s 230V green ø 10mm L 28mm		

indicator lights (complete)

ø10mm

with plug-in socket



<b>No.</b>	359139	<b>Ref. No.</b>	177.681
<b>description</b>	indicator light ø 10mm green 230V connection male faston 6.3mm Qty 1 pcs		



<b>No.</b>	359138	<b>Ref. No.</b>	177680
<b>description</b>	indicator light ø 10mm red 230V connection male faston 6.3mm Qty 1 pcs		

ø16mm

with plug-in socket



<b>No.</b>	359909	<b>Ref. No.</b>	BK178985
<b>description</b>	indicator light ø 16mm 230V green cable length 200mm cable material silicone wire		



<b>No.</b>	359908	<b>Ref. No.</b>	178999
<b>description</b>	indicator light ø 16mm 230V yellow cable length 200mm cable material silicone wire		



<b>No.</b>	359094	<b>Ref. No.</b>	1G962017
<b>description</b>	indicator light ø 16mm 400V yellow cable length 200mm cable material silicone wire		

screw-on/push-on fit

neon light bulbs



<b>No.</b>	359896	<b>Ref. No.</b>	887026
<b>description</b>	neon light bulb socket Ba9s 230V green ø 10mm L 28mm		



## timers

## audible timers



1

<b>No.</b>	350014	<b>Ref. No.</b>	279803
<b>description</b>	audible timer operation time 15min ø 56mm shaft ø 6x4.6mm shaft L 24mm mounting distance 28mm		

## contactors

## ABB

## power contactors



1

<b>No.</b>	380104	<b>Ref. No.</b>	279788
<b>description</b>	power contactor resistive load 25A 230VAC (AC3/400V) 9A/4kW main contacts 3NO auxiliary contacts 1NO connection screw connection type A9-30-10		

## HARTLAND

## power contactors

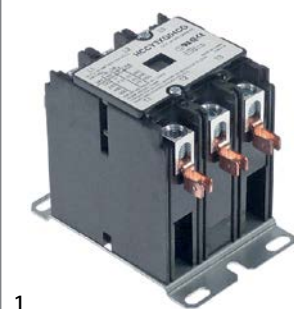

1

<b>No.</b>	381277	<b>Ref. No.</b>	719.384.213
<b>description</b>	power contactor resistive load 50A 24VAC 40A/10HP (AC3/240V) 40A/7.46kW main contacts 3NO auxiliary contacts connection screw clamp/male faston 6.3mm type HCCY3XQ04CG		

## solid state relays

## CRYDOM



1

<b>No.</b>	401563	<b>Ref. No.</b>	1G533279
<b>description</b>	solid state relay CRYDOM 1 phase 50A 600V 4-32VDC L 59mm W 46mm screw type HD4850-10		

accessories for 401563

<b>No.</b>	401564	<b>Ref. No.</b>	1G946000
<b>description</b>	heat-conducting foil L 62mm W 45mm for solid state relay		

## heat-conducting foils



1

<b>No.</b>	401564	<b>Ref. No.</b>	1G946000
<b>description</b>	heat-conducting foil L 62mm W 45mm for solid state relay		

## relays

## power relays

## with bracket mounting



1

<b>No.</b>	380403	<b>Ref. No.</b>	1G962019
<b>description</b>	power relays FINDER 230VAC 16A 3CO connection F6.3 bracket mounting manuf. no. 62.83.8.230.0500		

1

<b>No.</b>	380185	<b>Ref. No.</b>	1V420302
<b>description</b>	power relays Italiana Relè 230VAC 30A 1NO connection F6.3 bracket mounting dimensions 36.5x32.2x51.8mm manif. no. A10-230AC-FA		

## electronic controllers

### LAE

#### refrigeration controllers

##### built-in version



1

<b>No.</b>	379852	<b>Ref. No.</b>	1K267923
<b>description</b>	electronic controller LAE type AT1-5AS4D-G mounting measurements 71x29mm 12V voltage AC/DC NTC/PTC relay outputs 2 NO-16A(5) NO-4A(1) NTC/PTC front measurements 77x35mm built-in depth 70mm protection IP55 accuracy 1% defr. funct. -50 to +120°C display 3 digits		



1

<b>No.</b>	378043	<b>Ref. No.</b>	1K267923 old
<b>description</b>	electronic controller LAE type SDU12T0RD mounting measurements 71x29mm 12V voltage AC/DC PTC relay outputs 1 relay protection IP54 -19 up to +99°C compressor relay 5A		

## probes

### universal probes

#### temperature probes



1

<b>No.</b>	379860	<b>Ref. No.</b>	1V421494
<b>description</b>	temperature probe NTC 10kOhm cable PVC probe -20 up to +80°C cable -10 up to 100°C probe ø6x40mm cable length 1.5m without screw connection 2-wire		

### producer-specific probes

#### probes



1

<b>No.</b>	379880	<b>Ref. No.</b>	178881
<b>description</b>	temperature probe NTC 900kOhm cable silicone probe -40 up to +150°C cable -50 up to +180°C connection male faston thread probe ø6x80/170mm cable length 0.4m		



1

<b>No.</b>	379879	<b>Ref. No.</b>	BK178611
<b>description</b>	temperature probe NTC 900kOhm cable silicone probe -40 up to +150°C cable -50 up to +180°C connection male faston thread probe ø6x80/170mm cable length 0.65m		



1

<b>No.</b>	379882	<b>Ref. No.</b>	1G943000
<b>description</b>	temperature probe thermocouple K (NiCr-Ni) cable glass fibre probe -50 up to 1150°C cable -50 up to +350°C connection 2-wire probe ø4x20mm		
<b>accessories for</b>	379882		
	<b>No.</b>	<b>Ref. No.</b>	1G534536
	bayonet adapter L 66mm thread M6x1 ID ø 7/4mm ED ø 12mm		

### accessories

#### adapters



1

<b>No.</b>	379881	<b>Ref. No.</b>	1G534536
<b>description</b>	bayonet adapter L 66mm thread M6x1 ID ø 7/4mm ED ø 12mm		



## electronics

## PCBs



1

<b>No.</b>	401516	<b>Ref. No.</b>	BK178616
<b>description</b>	keypad PCB L 250mm W 75mm		



1

<b>No.</b>	401562	<b>Ref. No.</b>	1G534537
<b>description</b>	PCB		

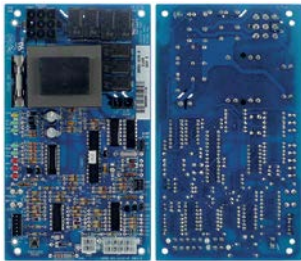

1

<b>No.</b>	403123	<b>Ref. No.</b>	719.391.063
<b>description</b>	PCB ice cube maker L 175mm W 99mm		



1

<b>No.</b>	403125	<b>Ref. No.</b>	719.391.097
<b>description</b>	PCB L 175mm W 99mm for ice-cube maker		



1

<b>No.</b>	400411	<b>Ref. No.</b>	179303
<b>description</b>	PCB pyroceram range CH 40/45/80 230V		

## solenoid valves

## solenoid valves (water)

## metal

## ASCO

## spare parts and accessories

## solenoid coils



1

<b>No.</b>	371113	<b>Ref. No.</b>	278270
<b>description</b>	solenoid coil Asco 230VAC 50Hz coil type 400526-117 seat ø 16mm		

## fans

## cross flow fans

## ebm-papst



1

<b>No.</b>	601437	<b>Ref. No.</b>	1V422429
<b>description</b>	cross flow fan ebm-papst QLZ06/1800-2518 roller ø 60mm roller length 180mm laminated core thickness 18mm motor position right 230V/50Hz 28W refrigeration bearing rubber connection male faston 6.3mm airflow 130m <sup>3</sup> /h 0 up to +60°C		



hot air fans

miscellaneous

1 

<b>No.</b>	500128	<b>Ref. No.</b>	295.101
<b>description</b>	hot air fan 230V 120W 0.53A 2000rpm L2 135mm L3 35mm L4 40mm fan wheel ø 180mm ebm-papst type R2E180-AI01-12		
<b>spare parts for</b>	500128		
	<b>No.</b>	365170	<b>Ref. No.</b>
			—

1 

capacitor capacity 2µF 425V tolerance 5% 50/60Hz ambient temperature max. -25 to +85°C ø 25mm L 49mm M8 plastic connection cable 250mm 416.17.74 protection

motors

gear motors

miscellaneous

1 

<b>No.</b>	602068	<b>Ref. No.</b>	6013212 AN7.000.240
<b>description</b>	gear motor MERKLE type B3715UP-095 3.45W 230V 50Hz 10rpm shaft ø 8mm L 125mm W 70mm H 75mm		

fuses

thermal fuses

1 

<b>No.</b>	358298	<b>Ref. No.</b>	1V421473
<b>description</b>	thermal fuse switch-off temp. 128°C nominal 10A		

electric accessories

plugs - couplings - power sockets

protective contact power sockets

universal

1 

<b>No.</b>	551128	<b>Ref. No.</b>	385.259
<b>description</b>	power socket CEE7/4 type F flush-mounted 3-pole contacts P+N+E max. 16A max 230V with lid countries D/I		

terminals

connection terminals with faston connections

1 

<b>No.</b>	550953	<b>Ref. No.</b>	1V420304
<b>description</b>	connection terminal 6-pole max. 20A max 450V connection F6.3/F6.3 temp.-resist. 90°C		

1 

<b>No.</b>	550954	<b>Ref. No.</b>	1V421490
<b>description</b>	connection terminal 9-pole max. 20A max 450V connection F6.3/F6.3 temp.-resist. 90°C		

electronic components

varistors

1 

<b>No.</b>	401565	<b>Ref. No.</b>	1G946001
<b>description</b>	varistor		

resistors

1 

<b>No.</b>	359502	<b>Ref. No.</b>	16-888002 BK178853
<b>description</b>	resistor 120KOhm 3W		



1			
<b>No.</b>	359503	<b>Ref. No.</b>	178854 1G888001
<b>description</b>	resistor 680KOhm		

## gas taps

PEL

22S/O series

1			
<b>No.</b>	106056	<b>Ref. No.</b>	BK178901
<b>description</b>	gas tap PEL type 22S/O gas inlet M20x1.5 (tube ø 12mm) bypass nozzle ø 0.35mm gas outlet M20x1.5 (tube ø 12/10mm) thermocouple connection M10x1 pilot connection M10x1 shaft ø 6x4.6mm shaft L 45/20mm shaft flat left		
<b>spare parts for</b>	106056		
	<b>No.</b>	101058	<b>Ref. No.</b> —
	magnet unit L 39mm D1 ø 15.4mm D2 ø 13.5mm suitable for PEL22/ EGA24197 standard		
	<b>No.</b>	101213	<b>Ref. No.</b> —
	gas tap front part shaft ø 6x4.6mm shaft L 45/20mm shaft flat right/ left suitable for PEL22		
	<b>No.</b>	101240	<b>Ref. No.</b> —
	gas connection thread M20x1.5 tube ø 12/10mm for PEL gas taps with gasket and screws horizontal		
	<b>No.</b>	101290	<b>Ref. No.</b> —
	thermocouple nut T1: M10x1 T2: M18x1 suitable for PEL20/21		
	<b>No.</b>	101460	<b>Ref. No.</b> —
	O-ring ø 12.37mm D1 ø 2.62mm suitable for PEL22		
	<b>No.</b>	101461	<b>Ref. No.</b> —
	screw kit suitable for PEL22 Qty 4 pcs		
<b>accessories for</b>	106056		
	<b>No.</b>	100908	<b>Ref. No.</b> —
	union screw thread M10x1 for pipe ø 4mm Qty 1 pcs		
	<b>No.</b>	100909	<b>Ref. No.</b> —
	union screw thread M10x1 for pipe ø 6mm Qty 1 pcs		
	<b>No.</b>	101241	<b>Ref. No.</b> —
	gas connection thread M20x1.5 tube ø 12/10mm for PEL gas taps vertical		
	<b>No.</b>	101246	<b>Ref. No.</b> —
	olive for pipe ø 4mm Qty 1 pcs		
	<b>No.</b>	101248	<b>Ref. No.</b> —
	olive for pipe ø 12mm Qty 1 pcs suitable for PEL		
	<b>No.</b>	101249	<b>Ref. No.</b> —
	olive for pipe ø 10mm Qty 1 pcs		
	<b>No.</b>	101250	<b>Ref. No.</b> —
	union nut thread M20x1.5 for pipe ø 10mm		

<b>accessories for</b>	106056		
	<b>No.</b>	101251	<b>Ref. No.</b> —
	union nut thread M20x1.5 for pipe ø 12mm		
	<b>No.</b>	101286	<b>Ref. No.</b> —
	olive ID ø 6mm Qty 1 pcs		
	<b>No.</b>	110080	<b>Ref. No.</b> —
	knob ø 70mm shaft ø 10x8mm shaft flat universal		
	<b>No.</b>	112206	<b>Ref. No.</b> —
	knob dial plate silver gas tap PEL21/22/23 t.max.°C ED ø 63mm ID ø 45.5mm		

## ignition parts

### pilot burners

AEM

### pilot burners

1			
<b>No.</b>	102906	<b>Ref. No.</b>	1G564253
<b>description</b>	pilot burner 1 flame gas connection 6mm mounting thread M5		
<b>accessories for</b>	102906		
	<b>No.</b>	106427	<b>Ref. No.</b> —
	pilot burner nozzle natural/liquid gas bore ø 0.3mm code 30 thread 7/32" (28G) WS 6		
	<b>No.</b>	106428	<b>Ref. No.</b> —
	pilot burner nozzle LPG bore ø 0.25mm code 25 thread 7/32" (28G) WS 6		
	<b>No.</b>	106429	<b>Ref. No.</b> —
	pilot burner nozzle natural gas bore ø 0.35mm thread M5x0.75 WS 6		

### electrodes

1			
<b>No.</b>	102907	<b>Ref. No.</b>	1G564251
<b>description</b>	ignition electrode D1 ø 7mm connection F 2.8x0.8mm L1 6mm L2 6mm L3 16mm BL1 50mm to clip		



ignition units

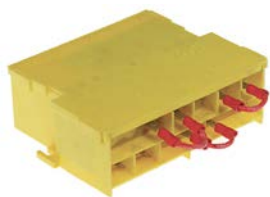

1	<b>No.</b>	102908	<b>Ref. No.</b>	1G564254
<b>description</b> ignition unit outputs 8 1.5 V/DC inlet F6.3x0.8 outlet F2.8x0.8 mounting ø 103mm				

ignition switches



1	<b>No.</b>	102909	<b>Ref. No.</b>	1G564255
<b>description</b> battery holder for battery type AA 1.5V mounting ø 19mm connection male faston 2.8mm				

thermocouples

plug-in thermocouples

plug-in thermocouples standard

with barrel socket ø6mm

type Junkers with aluminised tip

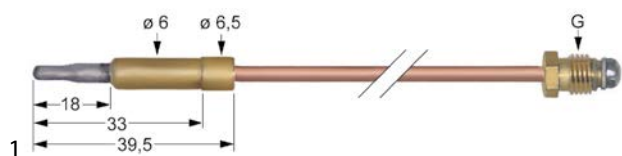

1	<b>No.</b>	102229	<b>Ref. No.</b>	178899
<b>description</b> thermocouple M10x1 L 1000mm plug connection ø6.0mm				

with barrel socket ø6(6.5)mm

thermocouples SIT

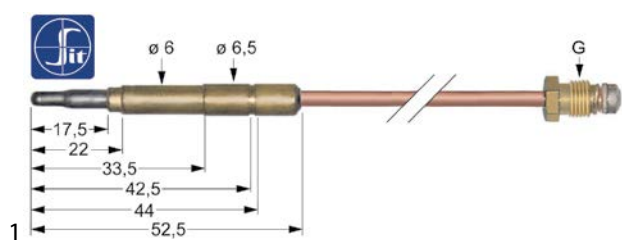

1	<b>No.</b>	107604	<b>Ref. No.</b>	1G564261
<b>description</b> thermocouple SIT M8x1 L 1200mm plug connection ø6.0(6.5)mm				

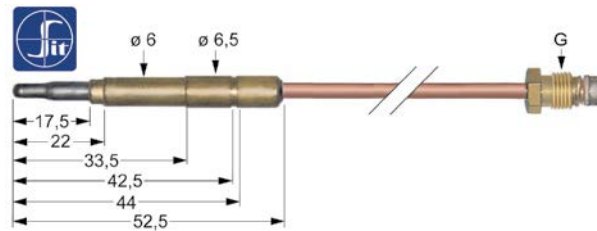

1	<b>No.</b>	107601	<b>Ref. No.</b>	1G564250
<b>description</b> thermocouple SIT M8x1 L 600mm plug connection ø6.0(6.5)mm				

gas nozzles

pilot burner nozzles

pilot burner nozzles JUNKERS

CB 50203\_/503\_ series



1	<b>No.</b>	100222	<b>Ref. No.</b>	178895 1G820090
<b>description</b> pilot burner nozzle LPG gas pressure 50mbar code 5 Qty 1 pcs suitable for JUNKERS CB50203_				

equipment-specific units

for convection ovens/combi-steamers

glass panels



1	<b>No.</b>	691256	<b>Ref. No.</b>	295582
<b>description</b> glass panel L 755mm W 690mm thickness 4mm				



## pullouts

### frame



1	<b>No.</b>	695464	<b>Ref. No.</b>	1V421650
	<b>description</b>	frame for pullout size 1/1 L 660mm		

1	<b>No.</b>	695468	<b>Ref. No.</b>	1V421651
	<b>description</b>	frame fortelescopic rail size 1/1 L 660mm capacity 120kg		

1	<b>No.</b>	695474	<b>Ref. No.</b>	1V421653
	<b>description</b>	frame fortelescopic rail size 2/1 L 760mm capacity 120kg		

1	<b>No.</b>	695471	<b>Ref. No.</b>	1V421652
	<b>description</b>	frame fortelescopic rail size 2/1 L 760mm capacity 70kg		

### rails

1	<b>No.</b>	695470	<b>Ref. No.</b>	1V421658
	<b>description</b>	rail L 660mm size 1/1 fortelescopic rail capacity 120kg		

1	<b>No.</b>	695466	<b>Ref. No.</b>	1V421682
	<b>description</b>	rail L 660mm size 1/1 fortelescopic rail capacity 70kg		

1	<b>No.</b>	695476	<b>Ref. No.</b>	1V421659
	<b>description</b>	rail L 760mm size 2/1 fortelescopic rail capacity 120kg		

1	<b>No.</b>	695473	<b>Ref. No.</b>	1V421683
	<b>description</b>	rail L 760mm size 2/1 fortelescopic rail capacity 70kg		

## drawer slides

### producer-specific

1	<b>No.</b>	695469	<b>Ref. No.</b>	1V421655
	<b>description</b>	pullout size 1/1 L 660mm capacity 120kg		

1	<b>No.</b>	695465	<b>Ref. No.</b>	1V421654
	<b>description</b>	pullout size 1/1 L 660mm capacity 70kg		





1			
<b>No.</b>	695475	<b>Ref. No.</b>	1V421657
<b>description</b>	pullout size 2/1 L 760mm capacity 120kg		

1			
<b>No.</b>	695472	<b>Ref. No.</b>	1V421656
<b>description</b>	pullout size 2/1 L 760mm capacity 70kg		

TENTE

with bolt hole

chrome-plated steel

			
1			
<b>No.</b>	700253	<b>Ref. No.</b>	719.383.405
<b>description</b>	swivel castor ø 125mm bolt hole bolt hole ø 11mm housing chrome-plated sheet steel capacity 100kg bearing slide bearing wheel body polypropylene tread TPE tyres H 160mm wheel width 32mm -20 up to +60°C Qty 1 pcs		

			
1			
<b>No.</b>	700254 <sup>1</sup>	<b>Ref. No.</b>	719.383.404
<b>description</b>	swivel castor with swivel brake ø 125mm bolt hole bolt hole ø 11mm housing chrome-plated sheet steel capacity 100kg bearing slide bearing wheel body polypropylene tread TPE tyres H 160mm wheel width 32mm -20 up to +60°C Qty 1 pcs		

<sup>1</sup>with swivel brake

baskets

fryer baskets

miscellaneous

			
1			
<b>No.</b>	993176	<b>Ref. No.</b>	718.384.803
<b>description</b>	basket W1 100mm L1 300mm H1 75mm chrome-plated steel baked potato/Sandwich		

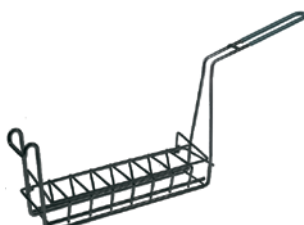
			
1			
<b>No.</b>	993264	<b>Ref. No.</b>	718.384.806
<b>description</b>	basket W1 100mm L1 300mm H1 75mm steel PTFE coated black		

warewashing baskets

system baskets CAMBRO 500x500mm

universal baskets

			
1			
<b>No.</b>	972102	<b>Ref. No.</b>	718.384.733
<b>description</b>	plate basket CAMBRO L 500mm W 500mm H 101mm usable height 83mm		

## shelves and shelf rails



### grates

#### universal

#### without upstand



1

<b>No.</b>	970122	<b>Ref. No.</b>	BI177994
<b>description</b>	grate W 325mm D 530mm GN 1/1 H 8mm stainless steel wire gauge frame 7mm lengthwise wires gauge 4mm crossing wires 1		
<b>accessories for</b>	970122		
	<b>No.</b>	690330	<b>Ref. No.</b>
	rack L 1000mm W 22mm H 4mm aperture 3x8mm hole distance 12.5mm stainless steel		
	<b>No.</b>	694700	<b>Ref. No.</b>
	shelf support L 31/28mm W 22mm H 18mm SS Qty 12 pcs		
	<b>No.</b>	694701	<b>Ref. No.</b>
	shelf support L 31/28mm W 22mm H 17mm SS with hook Qty 12 pcs		

### shelf rails and supports

#### producer-specific



1

<b>No.</b>	690615	<b>Ref. No.</b>	990166
<b>description</b>	pair of setting bar U-shape L 567mm W 13mm H 19mm mounting pos. left/right		

## gaskets

### refrigeration gaskets

#### plug-in gaskets

#### profile 9048

We offer custom-made gaskets for this profile

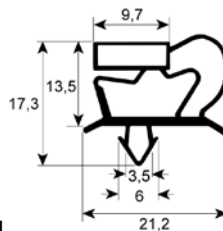

1

<b>No.</b>	900285	<b>Ref. No.</b>	925314
<b>description</b>	blast freezer gasket profile 9048 W 460mm L 580mm plug size for blast chiller		

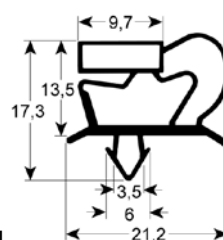

1

<b>No.</b>	901295	<b>Ref. No.</b>	719.390.556
<b>description</b>	refrigeration gasket profile 9048 W 418mm L 495mm plug size plug-in gasket		

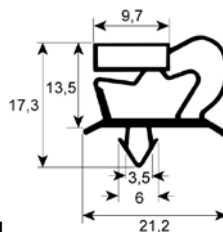

1

<b>No.</b>	900310	<b>Ref. No.</b>	935306
<b>description</b>	refrigeration gasket profile 9048 W 677mm L 1512mm plug size door		

#### profile 9794

We offer custom-made gaskets for this profile

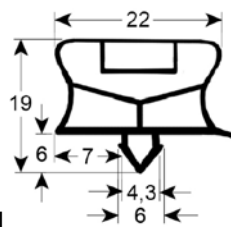

1

<b>No.</b>	900691	<b>Ref. No.</b>	925282
<b>description</b>	refrigeration gasket profile 9794 W 265mm L 390mm plug size		

<b>No.</b>	901558	<b>Ref. No.</b>	384.205
<b>description</b>	refrigeration gasket profile 9794 W 385mm L 635mm plug size		

<b>No.</b>	901597	<b>Ref. No.</b>	935307
<b>description</b>	refrigeration gasket profile 9794 W 678mm L 730mm plug size with magnet		

profile 9252

We offer custom-made gaskets for this profile

<b>No.</b>	901553	<b>Ref. No.</b>	384.212
<b>description</b>	refrigeration gasket profile 9252 W 410mm L 550mm plug size		

<b>No.</b>	901548	<b>Ref. No.</b>	384.217
<b>description</b>	refrigeration gasket profile 9252 W 455mm L 645mm plug size		

<b>No.</b>	901549	<b>Ref. No.</b>	719.388.206
<b>description</b>	refrigeration gasket profile 9252 W 455mm L 690mm plug size		

<b>No.</b>	901551	<b>Ref. No.</b>	384.215
<b>description</b>	refrigeration gasket profile 9252 W 530mm L 655mm plug size		

<b>No.</b>	901552	<b>Ref. No.</b>	384.213
<b>description</b>	refrigeration gasket profile 9252 W 610mm L 640mm plug size		

<b>No.</b>	901550	<b>Ref. No.</b>	384.214
<b>description</b>	refrigeration gasket profile 9252 W 640mm L 710mm plug size		

profile 9184

<b>No.</b>	902021	<b>Ref. No.</b>	719.388.221
<b>description</b>	refrigeration gasket profile 9184 W 570mm L 725mm plug size		

profile 9185

We offer custom-made gaskets for this profile

<b>No.</b>	901543	<b>Ref. No.</b>	384.152
<b>description</b>	refrigeration gasket profile 9185 W 365mm L 415mm plug size		

<b>No.</b>	901542	<b>Ref. No.</b>	251297-4M 384.558
<b>description</b>	refrigeration gasket profile 9185 W 380mm L 540mm plug size		

<b>No.</b>	901544	<b>Ref. No.</b>	384.557 4007069
<b>description</b>	refrigeration gasket profile 9185 W 385mm L 450mm plug size		

<b>No.</b>	901545	<b>Ref. No.</b>	384.233
<b>description</b>	refrigeration gasket profile 9185 W 395mm L 580mm plug size		

<b>No.</b>	901546	<b>Ref. No.</b>	384.153 700053
<b>description</b>	refrigeration gasket profile 9185 W 410mm L 575mm plug size		

<b>No.</b>	901547	<b>Ref. No.</b>	384.592
<b>description</b>	refrigeration gasket profile 9185 W 625mm L 715mm plug size		

<b>No.</b>	902271	<b>Ref. No.</b>	N/A
<b>description</b>	refrigeration gasket profile 9185 Wmm L 2500mm		

profile 9162

universal

<b>No.</b>	900071	<b>Ref. No.</b>	N/A
<b>description</b>	refrigeration gasket profile 9162 W 380mm L 225mm external size drawer for refrigerated counter refrigeration size 1/3		

<b>No.</b>	900070	<b>Ref. No.</b>	N/A
<b>description</b>	refrigeration gasket profile 9162 W 380mm L 652mm external size door for refrigerated counter refrigeration size 1/1		

<b>No.</b>	900073	<b>Ref. No.</b>	N/A
<b>description</b>	refrigeration gasket profile 9162 W 386mm L 200mm external size drawer for refrigerated counter refrigeration size 1/3		

<b>No.</b>	900072	<b>Ref. No.</b>	N/A
<b>description</b>	refrigeration gasket profile 9162 W 580mm L 335mm external size size 1/1		



<b>No.</b>	902269	<b>Ref. No.</b>	N/A
<b>description</b>	refrigeration gasket profile 9162 Wmm L 2500mm		

<b>No.</b>	900644	<b>Ref. No.</b>	1V420004
<b>description</b>	refrigeration gasket profile 9162 W 385mm L 321mm external size		

Salvis series 1999

<b>No.</b>	900640	<b>Ref. No.</b>	1V420000
<b>description</b>	refrigeration gasket profile 9162 W 385mm L 184mm external size		

<b>No.</b>	900645	<b>Ref. No.</b>	1V420005
<b>description</b>	refrigeration gasket profile 9162 W 385mm L 359mm external size		

<b>No.</b>	900641	<b>Ref. No.</b>	1V420001
<b>description</b>	refrigeration gasket profile 9162 W 385mm L 206mm external size		

<b>No.</b>	900647	<b>Ref. No.</b>	1V420007
<b>description</b>	refrigeration gasket profile 9162 W 385mm L 451mm external size		

<b>No.</b>	900642	<b>Ref. No.</b>	1V420002
<b>description</b>	refrigeration gasket profile 9162 W 385mm L 229mm external size		

<b>No.</b>	900648	<b>Ref. No.</b>	1V420008
<b>description</b>	refrigeration gasket profile 9162 W 385mm L 651mm external size		

<b>No.</b>	900643	<b>Ref. No.</b>	1V420003
<b>description</b>	refrigeration gasket profile 9162 W 385mm L 314mm external size		

<b>No.</b>	900649	<b>Ref. No.</b>	1V420009
<b>description</b>	refrigeration gasket profile 9162 W 385mm L 781mm external size		

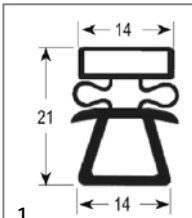

<b>No.</b>	900650	<b>Ref. No.</b>	1V420010
<b>description</b>	refrigeration gasket profile 9162 W 585mm L 184mm external size		

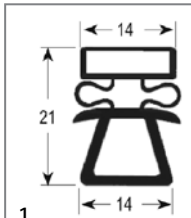

<b>No.</b>	900655	<b>Ref. No.</b>	1V420015
<b>description</b>	refrigeration gasket profile 9162 W 585mm L 359mm external size		

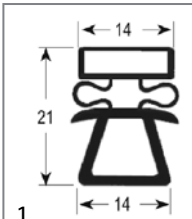

<b>No.</b>	900651	<b>Ref. No.</b>	1V420011
<b>description</b>	refrigeration gasket profile 9162 W 585mm L 206mm external size		

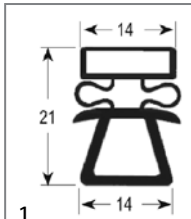

<b>No.</b>	900656	<b>Ref. No.</b>	1V420016
<b>description</b>	refrigeration gasket profile 9162 W 585mm L 406mm external size		

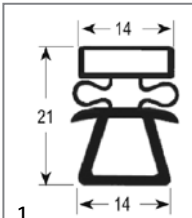

<b>No.</b>	900652	<b>Ref. No.</b>	1V420012
<b>description</b>	refrigeration gasket profile 9162 W 585mm L 229mm external size		

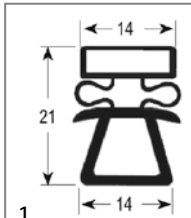

<b>No.</b>	900657	<b>Ref. No.</b>	1V420017
<b>description</b>	refrigeration gasket profile 9162 W 585mm L 451mm external size		

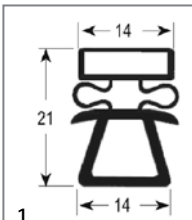

<b>No.</b>	900653	<b>Ref. No.</b>	1V420013
<b>description</b>	refrigeration gasket profile 9162 W 585mm L 314mm external size		

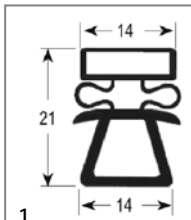

<b>No.</b>	900658	<b>Ref. No.</b>	1V420018
<b>description</b>	refrigeration gasket profile 9162 W 585mm L 651mm external size		

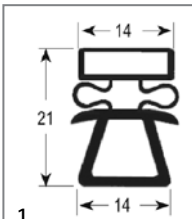

<b>No.</b>	900654	<b>Ref. No.</b>	1V420014
<b>description</b>	refrigeration gasket profile 9162 W 585mm L 314mm external size		

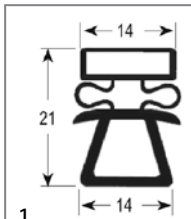

<b>No.</b>	900659	<b>Ref. No.</b>	1V420019
<b>description</b>	refrigeration gasket profile 9162 W 585mm L 781mm external size		



Salvis series 2000

<b>No.</b>	900660	<b>Ref. No.</b>	1V421560
<b>description</b>	refrigeration gasket profile 9162 W 385mm L 185mm external size		

<b>No.</b>	900665	<b>Ref. No.</b>	1V421565
<b>description</b>	refrigeration gasket profile 9162 W 385mm L 320mm external size		

<b>No.</b>	900661	<b>Ref. No.</b>	1V421561
<b>description</b>	refrigeration gasket profile 9162 W 385mm L 206mm external size		

<b>No.</b>	900666	<b>Ref. No.</b>	1V421566
<b>description</b>	refrigeration gasket profile 9162 W 385mm L 354mm external size		

<b>No.</b>	900662	<b>Ref. No.</b>	1V421562
<b>description</b>	refrigeration gasket profile 9162 W 385mm L 224mm external size		

<b>No.</b>	900667	<b>Ref. No.</b>	1V421567
<b>description</b>	refrigeration gasket profile 9162 W 385mm L 405mm external size		

<b>No.</b>	900663	<b>Ref. No.</b>	1V421563
<b>description</b>	refrigeration gasket profile 9162 W 385mm L 309mm external size		

<b>No.</b>	900668	<b>Ref. No.</b>	1V421568
<b>description</b>	refrigeration gasket profile 9162 W 385mm L 445mm external size		

<b>No.</b>	900664	<b>Ref. No.</b>	1V421564
<b>description</b>	refrigeration gasket profile 9162 W 385mm L 318mm external size		

<b>No.</b>	900669	<b>Ref. No.</b>	1V421569
<b>description</b>	refrigeration gasket profile 9162 W 385mm L 642mm external size		



<b>No.</b>	900670	<b>Ref. No.</b>	1V421570
<b>description</b>	refrigeration gasket profile 9162 W 385mm L 772mm external size		

<b>No.</b>	900675	<b>Ref. No.</b>	1V421584
<b>description</b>	refrigeration gasket profile 9162 W 585mm L 318mm external size		

<b>No.</b>	900671	<b>Ref. No.</b>	1V421580
<b>description</b>	refrigeration gasket profile 9162 W 585mm L 188mm external size		

<b>No.</b>	900676	<b>Ref. No.</b>	1V421585
<b>description</b>	refrigeration gasket profile 9162 W 585mm L 321mm external size		

<b>No.</b>	900672	<b>Ref. No.</b>	1V421581
<b>description</b>	refrigeration gasket profile 9162 W 585mm L 206mm external size		

<b>No.</b>	900677	<b>Ref. No.</b>	1V421586
<b>description</b>	refrigeration gasket profile 9162 W 585mm L 354mm external size		

<b>No.</b>	900673	<b>Ref. No.</b>	1V421582
<b>description</b>	refrigeration gasket profile 9162 W 585mm L 224mm external size		

<b>No.</b>	900678	<b>Ref. No.</b>	1V421587
<b>description</b>	refrigeration gasket profile 9162 W 585mm L 406mm external size		

<b>No.</b>	900674	<b>Ref. No.</b>	1V421583
<b>description</b>	refrigeration gasket profile 9162 W 585mm L 309mm external size		

<b>No.</b>	900679	<b>Ref. No.</b>	1V421588
<b>description</b>	refrigeration gasket profile 9162 W 585mm L 442mm external size		



<b>No.</b>	900680	<b>Ref. No.</b>	1V421589
<b>description</b>	refrigeration gasket profile 9162 W 585mm L 642mm external size		

<b>No.</b>	900681	<b>Ref. No.</b>	1V421590
<b>description</b>	refrigeration gasket profile 9162 W 585mm L 772mm external size		

screw-in gaskets

profile 9207

We offer custom-made gaskets for this profile

<b>No.</b>	901554	<b>Ref. No.</b>	719.388.204
<b>description</b>	refrigeration gasket profile 9207 W 404mm L 595mm external size magnet 3-sided		

<b>No.</b>	901555	<b>Ref. No.</b>	719.388.203
<b>description</b>	refrigeration gasket profile 9207 W 595mm L 699mm external size magnet 3-sided		

profile 9191

We offer custom-made gaskets for this profile

<b>No.</b>	901556	<b>Ref. No.</b>	719.388.202
<b>description</b>	refrigeration gasket profile 9191 W 330mm L 590mm external size		

miscellaneous

<b>No.</b>	902026	<b>Ref. No.</b>	384.331 700396
<b>description</b>	gasket		

gaskets for heated units

door seals

<b>No.</b>	900100	<b>Ref. No.</b>	1L295594
<b>description</b>	door seal profile 2070 W 460mm L 645mm external size Qty 1 6 x 1/1		

<b>No.</b>	900101	<b>Ref. No.</b>	295593
<b>description</b>	door seal profile 2070 W 645mm L 700mm external size Qty 1 10 x 1/1		

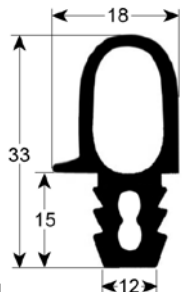

<b>No.</b>	900497	<b>Ref. No.</b>	742376
<b>description</b>	door seal profile 2449 W 520mm L 775mm Qty 1		

**miscellaneous**

profile 2218





<b>No.</b>	901557	<b>Ref. No.</b>	181275 384.216
<b>description</b>	gasket profile 2218 W 180mm L 920mm external size Qty 1 suitable for FRANKE perforated		



<b>No.</b>	993276	<b>Ref. No.</b>	270.067.05
<b>description</b>	scraper with scraper L 310mm W 127mm H 65mm for 10:1		
<b>spare parts for</b>	993276		
	<b>No.</b>	993273	<b>Ref. No.</b> —
	scraper W 45mm L 110mm for 10:1		



<b>No.</b>	993277	<b>Ref. No.</b>	400.896.0
<b>description</b>	scraper with scraper L 310mm W 130mm H 60mm for 4:1		
<b>spare parts for</b>	993277		
	<b>No.</b>	993275	<b>Ref. No.</b> —
	scraper W 45mm L 130mm for 4:1		



<b>No.</b>	993300	<b>Ref. No.</b>	719.395.492
<b>description</b>	screw		

**gastronorm**

trays and inserts



<b>No.</b>	993232	<b>Ref. No.</b>	718.383.401
<b>description</b>	crumb tray W 216mm L 648mm H 54mm for UHC yellow		



<b>No.</b>	993225	<b>Ref. No.</b>	718.385.348
<b>description</b>	tray „Opti-Loc“ W 143mm L 654mm H 56mm for UHC grey		

**kitchen accessories**

**accessories**



<b>No.</b>	993248	<b>Ref. No.</b>	719.385.163
<b>description</b>	container for Accu-Salt		

**preparation**



<b>No.</b>	993270	<b>Ref. No.</b>	719.387.936
<b>description</b>	measuring cup 1000ml stainless steel		



<b>No.</b>	993268	<b>Ref. No.</b>	718.385.085
<b>description</b>	plier L 165mm chrome-plated steel		



GN containers

SS 18/10 - standard



1

<b>No.</b>	993035	<b>Ref. No.</b>	384.465
<b>description</b>	GN container SS 18/10 size GN 1/1 D 150mm		
<b>accessories for</b>	993035		
	<b>No.</b>	993074	<b>Ref. No.</b> 718.384.003
lid SS 18/10 size GN 1/1 for GN container			



1

<b>No.</b>	993036	<b>Ref. No.</b>	718.382.333 CNS
<b>description</b>	GN container SS 18/10 size GN 1/1 D 200mm		
<b>accessories for</b>	993036		
	<b>No.</b>	993074	<b>Ref. No.</b> 718.384.003
lid SS 18/10 size GN 1/1 for GN container			



1

<b>No.</b>	993030	<b>Ref. No.</b>	718.383.365
<b>description</b>	GN container SS 18/10 size GN 1/1 D 20mm		
<b>accessories for</b>	993030		
	<b>No.</b>	993074	<b>Ref. No.</b> 718.384.003
lid SS 18/10 size GN 1/1 for GN container			



1

<b>No.</b>	993019	<b>Ref. No.</b>	384.960
<b>description</b>	GN container SS 18/10 size GN 1/1 D 55mm		
<b>accessories for</b>	993019		
	<b>No.</b>	993074	<b>Ref. No.</b> 718.384.003
lid SS 18/10 size GN 1/1 for GN container			



1

<b>No.</b>	993033	<b>Ref. No.</b>	718.382.318
<b>description</b>	GN container SS 18/10 size GN 1/1 D 65mm		
<b>accessories for</b>	993033		
	<b>No.</b>	993074	<b>Ref. No.</b> 718.384.003
lid SS 18/10 size GN 1/1 for GN container			



1

<b>No.</b>	993045	<b>Ref. No.</b>	718.382.367
<b>description</b>	GN container SS 18/10 size GN 1/2 D 100mm		
<b>accessories for</b>	993045		
	<b>No.</b>	993076	<b>Ref. No.</b> 384..090
lid SS 18/10 size GN 1/2 for GN container			



1

<b>No.</b>	993046	<b>Ref. No.</b>	718.383.117
<b>description</b>	GN container SS 18/10 size GN 1/2 D 150mm		
<b>accessories for</b>	993046		
	<b>No.</b>	993076	<b>Ref. No.</b> 384..090
lid SS 18/10 size GN 1/2 for GN container			



1

<b>No.</b>	993047	<b>Ref. No.</b>	718.382.366
<b>description</b>	GN container SS 18/10 size GN 1/2 D 200mm		



1

<b>No.</b>	993044	<b>Ref. No.</b>	S18.000.404 CNS
<b>description</b>	GN container SS 18/10 size GN 1/2 D 65mm		
<b>accessories for</b>	993044		
	<b>No.</b>	993076	<b>Ref. No.</b> 384..090
lid SS 18/10 size GN 1/2 for GN container			



1

<b>No.</b>	993049	<b>Ref. No.</b>	718.384.163 CNS
<b>description</b>	GN container SS 18/10 size GN 1/3 D 100mm		



1

<b>No.</b>	993050	<b>Ref. No.</b>	718.382.385
<b>description</b>	GN container SS 18/10 size GN 1/3 D 150mm		



1

<b>No.</b>	993051	<b>Ref. No.</b>	718.384.367
<b>description</b>	GN container SS 18/10 size GN 1/3 D 200mm		



1

<b>No.</b>	993048	<b>Ref. No.</b>	384.028
<b>description</b>	GN container SS 18/10 size GN 1/3 D 65mm		
<b>accessories for</b>	993048		
	<b>No.</b>	993077	<b>Ref. No.</b> 719.388.050
lid SS 18/10 size GN 1/3 for GN container			



1

<b>No.</b>	993053	<b>Ref. No.</b>	718.383.419
<b>description</b>	GN container SS 18/10 size GN 1/4 D 100mm		
<b>accessories for</b>	993053		
	<b>No.</b>	993078	<b>Ref. No.</b>
			—
	lid SS 18/10 size GN 1/4 for GN container		



1

<b>No.</b>	993056	<b>Ref. No.</b>	718.382.331
<b>description</b>	GN container SS 18/10 size GN 1/6 D 65mm		
<b>accessories for</b>	993056		
	<b>No.</b>	993076	<b>Ref. No.</b>
			384..090
	lid SS 18/10 size GN 1/2 for GN container		



1

<b>No.</b>	993057	<b>Ref. No.</b>	718.382.315
<b>description</b>	GN container SS 18/10 size GN 1/6 D 100mm		
<b>accessories for</b>	993057		
	<b>No.</b>	993079	<b>Ref. No.</b>
			718.382.322
	lid SS 18/10 size GN 1/6 for GN container		



1

<b>No.</b>	993061	<b>Ref. No.</b>	718.382.972
<b>description</b>	GN container SS 18/10 size GN 1/9 D 100mm		
<b>accessories for</b>	993061		
	<b>No.</b>	993080	<b>Ref. No.</b>
			P18.000.038
	lid SS 18/10 size GN 1/9 for GN container		



1

<b>No.</b>	993058	<b>Ref. No.</b>	718.382.386
<b>description</b>	GN container SS 18/10 size GN 1/6 D 150mm		
<b>accessories for</b>	993058		
	<b>No.</b>	993079	<b>Ref. No.</b>
			718.382.322
	lid SS 18/10 size GN 1/6 for GN container		



1

<b>No.</b>	993041	<b>Ref. No.</b>	717.918.316
<b>description</b>	GN container SS 18/10 size GN 2/3 D 150mm		
<b>accessories for</b>	993041		
	<b>No.</b>	993075	<b>Ref. No.</b>
			717.918.315
	lid SS 18/10 size GN 2/3 for GN container		



1

<b>No.</b>	993106	<b>Ref. No.</b>	718.382.358
<b>description</b>	GN container SS 18/10 size GN 2/3 D 200mm		
<b>accessories for</b>	993106		
	<b>No.</b>	993075	<b>Ref. No.</b> 717.918.315
	lid SS 18/10 size GN 2/3 for GN container		



1

<b>No.</b>	993110	<b>Ref. No.</b>	384.679
<b>description</b>	GN container SS 18/10 size GN 2/4 D 150mm		

SS 18/10 - perforated



1

<b>No.</b>	993073	<b>Ref. No.</b>	718.385.230
<b>description</b>	GN container SS 18/10 size GN 1/2 perforated D 100mm		
<b>accessories for</b>	993073		
	<b>No.</b>	993076	<b>Ref. No.</b> 384.090
	lid SS 18/10 size GN 1/2 for GN container		

polycarbonate



1

<b>No.</b>	993023	<b>Ref. No.</b>	S18.000.384
<b>description</b>	GN container polycarbonate size GN 1/1 D 150mm		
<b>accessories for</b>	993023		
	<b>No.</b>	993094	<b>Ref. No.</b> S18.000.389
	lid polycarbonate size GN 1/1		





1

<b>No.</b>	993024	<b>Ref. No.</b>	718.382.333
<b>description</b>	GN container polycarbonate size GN 1/1 D 200mm		
<b>accessories for</b>	993024		
	<b>No.</b>	993094	<b>Ref. No.</b> S18.000.389
	lid polycarbonate size GN 1/1		





1

<b>No.</b>	993027	<b>Ref. No.</b>	S18.000.385
<b>description</b>	GN container polycarbonate size GN 1/2 D 150mm		
<b>accessories for</b>	993027		
	<b>No.</b>	993095	<b>Ref. No.</b> S18.000.390
	lid polycarbonate size GN 1/2		





1

<b>No.</b>	993028	<b>Ref. No.</b>	718.384.164
<b>description</b>	GN container polycarbonate size GN 1/2 D 200mm		
<b>accessories for</b>	993028		
	<b>No.</b>	993095	<b>Ref. No.</b> 518.000.390
lid polycarbonate size GN 1/2			





1

<b>No.</b>	993032	<b>Ref. No.</b>	718.384.163
<b>description</b>	GN container polycarbonate size GN 1/3 D 200mm		
<b>accessories for</b>	993032		
	<b>No.</b>	993096	<b>Ref. No.</b> 718.382.393
lid polycarbonate size GN 1/3			





1

<b>No.</b>	993031	<b>Ref. No.</b>	518.000.404
<b>description</b>	GN container polycarbonate size GN 1/3 D 100mm		
<b>accessories for</b>	993031		
	<b>No.</b>	993096	<b>Ref. No.</b> 718.382.393
lid polycarbonate size GN 1/3			





1

<b>No.</b>	993029	<b>Ref. No.</b>	518.000.380
<b>description</b>	GN container polycarbonate size GN 1/3 D 65mm		
<b>accessories for</b>	993029		
	<b>No.</b>	993096	<b>Ref. No.</b> 718.382.393
lid polycarbonate size GN 1/3			



1

<b>No.</b>	993015	<b>Ref. No.</b>	518.000.386
<b>description</b>	GN container polycarbonate size GN 1/3 D 150mm		
<b>accessories for</b>	993015		
	<b>No.</b>	993096	<b>Ref. No.</b> 718.382.393
lid polycarbonate size GN 1/3			



1

<b>No.</b>	993090	<b>Ref. No.</b>	518.000.407
<b>description</b>	GN container polycarbonate size GN 1/6 D 100mm		
<b>accessories for</b>	993090		
	<b>No.</b>	993098	<b>Ref. No.</b> 718.382.558
lid polycarbonate size GN 1/6			





1

<b>No.</b>	993091	<b>Ref. No.</b>	S18.000.388
<b>description</b>	GN container polycarbonate size GN 1/6 D 150mm		
<b>accessories for</b>	993091		
	<b>No.</b>	993098	<b>Ref. No.</b> 718.382.558
	lid polycarbonate size GN 1/6		



1

<b>No.</b>	993089	<b>Ref. No.</b>	718.385.377
<b>description</b>	GN container polycarbonate size GN 1/6 D 65mm		
<b>accessories for</b>	993089		
	<b>No.</b>	993098	<b>Ref. No.</b> 718.382.558
	lid polycarbonate size GN 1/6		



1

<b>No.</b>	993093	<b>Ref. No.</b>	S18.000.408
<b>description</b>	GN container polycarbonate size GN 1/9 D 100mm		

lids

1

<b>No.</b>	993094	<b>Ref. No.</b>	S18.000.389
<b>description</b>	lid polycarbonate size GN 1/1		

1

<b>No.</b>	993095	<b>Ref. No.</b>	S18.000.390
<b>description</b>	lid polycarbonate size GN 1/2		

1

<b>No.</b>	993096	<b>Ref. No.</b>	718.382.393
<b>description</b>	lid polycarbonate size GN 1/3		

1

<b>No.</b>	993098	<b>Ref. No.</b>	718.382.558
<b>description</b>	lid polycarbonate size GN 1/6		

1

<b>No.</b>	993074	<b>Ref. No.</b>	718.384.003
<b>description</b>	lid SS 18/10 size GN 1/1 for GN container		

1

<b>No.</b>	993076	<b>Ref. No.</b>	384.090
<b>description</b>	lid SS 18/10 size GN 1/2 for GN container		



			
1			
<b>No.</b>	993077	<b>Ref. No.</b>	719.388.050
<b>description</b>	lid SS 18/10 size GN 1/3 for GN container		

			
1			
<b>No.</b>	993079	<b>Ref. No.</b>	718.382.322
<b>description</b>	lid SS 18/10 size GN 1/6 for GN container		

			
1			
<b>No.</b>	993080	<b>Ref. No.</b>	P18.000.038
<b>description</b>	lid SS 18/10 size GN 1/9 for GN container		

			
1			
<b>No.</b>	993075	<b>Ref. No.</b>	717.918.315
<b>description</b>	lid SS 18/10 size GN 2/3 for GN container		

## hoses

### pre-rinse hoses

#### stainless steel flexi hoses

			
1			
<b>No.</b>	699838	<b>Ref. No.</b>	K19.000.183
<b>description</b>	hose L 800mm		

## water filters

### EVERPURE

#### filters

#### for cold drinks

			
1			
<b>No.</b>	530101	<b>Ref. No.</b>	719389139
<b>description</b>	water filter EVERPURE type 4C capacity 11000l flow rate 114l/h operation p max 10bar water temperature max. 38°C filter power 0.5µm for filter head QL2/QL3 ø 80mm H 370mm activated carbon filtration for beverage vending machine		
<b>accessories for</b>	530101		
		<b>No.</b>	520218
		<b>Ref. No.</b>	—
	double nipple brass thread 3/8" - 3/4" Qty 1 pcs L1 12mm L2 12mm		
		<b>No.</b>	530106
		<b>Ref. No.</b>	—
	filter head EVERPURE type QL3 connection 3/8" vertical with shut-off valve ø 96mm H 90mm		
		<b>No.</b>	530115
		<b>Ref. No.</b>	—
	filter head EVERPURE type QL2 connection 3/8" horizontal without shut-off valve ø 96mm H 80mm		

## consumables

### fuses

#### thermal fuses

			
1			
<b>No.</b>	358298	<b>Ref. No.</b>	1V421473
<b>description</b>	thermal fuse switch-off temp. 128°C nominal 10A		