

# Professionall

Solutii profesionale pentru echipamente profesionale



**GAS COMPONENTS**



**ELECTRIC COMPONENTS**



**WATER TECHNOLOGY**



**MECHANICAL COMPONENTS**



**TOOLS**

Spare parts suitable for

# EURFRIGOR



## thermostats

### refrigeration thermostats

#### RANCO

##### K22 series

RANCO



1

|                    |   |                 |          |
|--------------------|---|-----------------|----------|
| <b>No.</b>         | 390524  | <b>Ref. No.</b> | RFS0B893 |
| <b>description</b> | thermostat RANCO type K22L1082 probe ømm probe Lmm capillary pipe 2000mm temperature range -22 up to -3°C |                 |          |

RANCO



1

|                    |  |                 |          |
|--------------------|--|-----------------|----------|
| <b>No.</b>         | 390296   | <b>Ref. No.</b> | RF000618 |
| <b>description</b> | thermostat RANCO type K22-L2069 probe ø 2mm probe L 10mm capillary pipe 1500mm |                 |          |

##### K50 series

RANCO



1

|                    |  |                 |          |
|--------------------|--|-----------------|----------|
| <b>No.</b>         | 390270   | <b>Ref. No.</b> | RF000610 |
| <b>description</b> | thermostat RANCO type K50L3019 probe ømm probe Lmm capillary pipe 1250mm temperature range +1 up to +7.5°C |                 |          |

RANCO



1

|                    |  |                 |          |
|--------------------|--|-----------------|----------|
| <b>No.</b>         | 390286   | <b>Ref. No.</b> | RFS0B892 |
| <b>description</b> | thermostat RANCO type K50L3383 probe ømm probe Lmm capillary pipe 1500mm temperature range +1 up to +3°C |                 |          |

## switches and momentary switches

### rocker/momentary rocker switches

#### 30x22mm

##### labelled



1

|   |   |                 |                 |   |
|---|---|-----------------|-----------------|---|
| <b>No.</b>  | 346870  | <b>Ref. No.</b> | RI000751        |   |
| <b>description</b>  | rocker switch mounting measurements 30x22mm blue 2NO 250V 16A illuminated 0-1 connection male faston 6.3mm ambient temperature max. 85°C protection IP65 with cover cap |                 |                 |   |
| <b>accessories for</b>  | 346870  |                 |                 |   |
|  | <b>No.</b>  | 301036          | <b>Ref. No.</b> | — |
|   | protective cover internal size 30x22mm for rocker switch mounting measurementsmm  |                 |                 |   |

### push/momentary push switches

#### 19x13mm



1

|   |   |                 |                 |   |
|---|---|-----------------|-----------------|---|
| <b>No.</b>  | 346871 <sup>1</sup>   | <b>Ref. No.</b> | RI00B281        |   |
| <b>description</b>  | push switch mounting measurements 19x13mm green 2NO 250V 16A illuminated connection male faston 4.8mm ambient temperature max. 105/55°C protection IP40 |                 |                 |   |
| <b>accessories for</b>  | 346871  |                 |                 |   |
|  | <b>No.</b>  | 346541          | <b>Ref. No.</b> | — |
|   | protective cover for rocker switch external size 23.4x17.4mm internal size 19x13mm H 9.5mm mounting measurementsmm                                      |                 |                 |   |

<sup>1</sup>illuminated

#### ø25mm



1

|   |   |                 |                 |   |
|---|---|-----------------|-----------------|---|
| <b>No.</b>  | 345011  | <b>Ref. No.</b> | RI00C883        |   |
| <b>description</b>  | push switch mounting ø 25mm green 2NO 250V 16A illuminated connection male faston 6.3mm ambient temperature max. 85°C protection IP65 |                 |                 |   |
| <b>accessories for</b>  | 345011  |                 |                 |   |
|  | <b>No.</b>  | 345039          | <b>Ref. No.</b> | — |
|   | protective cover round ED ø 33mm external size 23mm internal size 21mm H 12mm clear mounting ø 25mm                                   |                 |                 |   |



## microswitches

## lever actuated



1

|                    |   |                 |          |
|--------------------|---|-----------------|----------|
| <b>No.</b>         | 346872  | <b>Ref. No.</b> | RI000800 |
| <b>description</b> | microswitch with lever 250V 0.1A 1CO connection male faston 6.3mm L 50mm ambient temperature max. 85°C mounting distance 22mm type D41X actuating force: 6g lever length 36mm |                 |          |

## roller-lever actuated

## with mounting components



1

|                    |  |                 |          |
|--------------------|--|-----------------|----------|
| <b>No.</b>         | 347568   | <b>Ref. No.</b> | RI00A240 |
| <b>description</b> | microswitch with handle with a switch 250V 10A 1CO connection male faston 6.3mm L 25mm ambient temperature max. 85°C mounting distance 24mm type VR actuating force: 50g lever length 31mm |                 |          |



1

|                    |   |                 |          |
|--------------------|---|-----------------|----------|
| <b>No.</b>         | 345370  | <b>Ref. No.</b> | RH003800 |
| <b>description</b> | microswitch with handle with a switch 250V 16A 1CO connection male faston 6.3mm L 27mm ambient temperature max. 125°C mounting distance 24mm actuating force: 45g lever length 26.5mm |                 |          |

## float switches



1

|                    |  |                 |                      |
|--------------------|--|-----------------|----------------------|
| <b>No.</b>         | 345372   | <b>Ref. No.</b> | RH000830<br>RI00A241 |
| <b>description</b> | float switch 1CO ø 15mm L 104mm 250V 6A male faston 6.3mm cable lengthmm |                 |                      |



1

|                    |  |                 |          |
|--------------------|--|-----------------|----------|
| <b>No.</b>         | 345371   | <b>Ref. No.</b> | RH00A310 |
| <b>description</b> | float switch with plunger 250V 16A 1CO male faston 6.3mm L 60mm ambient temperature max. 125°C mounting distance 22mm type EF83161.5 actuating force: 20g blue/black |                 |          |

## floats



1

|                    |        |                 |          |
|--------------------|--------|-----------------|----------|
| <b>No.</b>         | 695044 | <b>Ref. No.</b> | RH000679 |
| <b>description</b> | float  |                 |          |

## timers

## programme timers



1

|  |  |                 |                 |   |
|--|--|-----------------|-----------------|---|
| <b>No.</b>   | 360524   | <b>Ref. No.</b> | RFS0B869        |   |
| <b>description</b>   | timer CDC 11904 engines 1 chambers 4 operation time 12min 230V shaft ømm shaft Lmm manuf. no. 11904F1 / BDR000.0000 motor type M48R ATS                        |                 |                 |   |
| <b>spare parts for</b>   | 360524   |                 |                 |   |
|  | <b>No.</b>   | 360118          | <b>Ref. No.</b> | — |
|  | motor CDC pinion ø 4.9mm teeth 10 230V voltage AC 50/60Hz turn direction right motor ø 47mm H 19.3mm motor type M48R ATS for timer cable length 260mm 1.9/2.5W |                 |                 |   |



1

|                    |   |                 |          |
|--------------------|---|-----------------|----------|
| <b>No.</b>         | 360609  | <b>Ref. No.</b> | RFS0C111 |
| <b>description</b> | timer CDC 11904 engines 1 chambers 4 operation time 15min 230V 60Hz shaft ømm shaft Lmm manuf. no. 11904F1BEY000.0010 |                 |          |

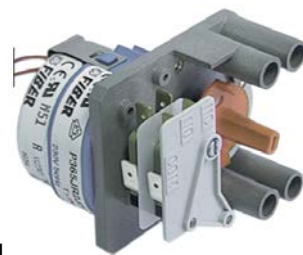

1

|   |  |                 |                 |   |
|---|--|-----------------|-----------------|---|
| <b>No.</b>  | 360051   | <b>Ref. No.</b> | RES0A822        |   |
| <b>description</b>  | timer FIBER P36 engines 1 chambers 2 operation time 15min 230V shaft ømm shaft Lmm manuf. no. P365JR2J717 motor type M51B-J0R6400                                  |                 |                 |   |
| <b>spare parts for</b>  | 360051   |                 |                 |   |
|  | <b>No.</b>   | 360673          | <b>Ref. No.</b> | — |
|   | motor kit pinion ø 6.8mm teeth 15 230V voltage AC 50/60Hz turn direction clockwise motor ø 48mm H 18.5mm motor type UDS-40NE1RNZ165 cable length 150mm with holder |                 |                 |   |



## relays

### power relays

#### with bracket mounting





1

|                    |  |                 |          |
|--------------------|--|-----------------|----------|
| <b>No.</b>         | 380312   | <b>Ref. No.</b> | RI000761 |
| <b>description</b> | power relays FINDER 230VAC 10A 3CO connection male faston 4.8mm bracket mounting dimensions 52x32.2x36.5mm manuf. no. 60.63.8.230.0000 |                 |          |



1

|   |  |                 |                          |
|---|--|-----------------|--------------------------|
| <b>No.</b>  | 380329   | <b>Ref. No.</b> | RF000555                 |
| <b>description</b>  | time relay FIBER 85.02.8.240 time range 0.05s - 100h 230-240VAC 10A mounting measurements 20.6x27.7mm 2CO connection 2.0 |                 |                          |
| <b>accessories for</b>  | 380329   |                 |                          |
|  | <b>No.</b>   | 380378          | <b>Ref. No.</b> RF000556 |
|   | relay socket 2-pole 55/85 dimensions 70.5x30x27mm 250V voltage AC 10A FINDER manuf. no. 94.72                            |                 |                          |
|  | <b>No.</b>   | 380803          | <b>Ref. No.</b> —        |
|   | relay socket 2-pole dimensions 76.2x27x86.1mm 250V voltage AC 10A FINDER manuf. no. 94.92.3                              |                 |                          |

### relay sockets

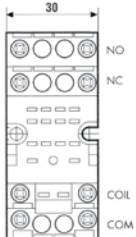



1

|   |   |                 |                   |
|---|---|-----------------|-------------------|
| <b>No.</b>  | 380378  | <b>Ref. No.</b> | RF000556          |
| <b>description</b>  | relay socket 2-pole 55/85 dimensions 70.5x30x27mm 250V voltage AC 10A FINDER manuf. no. 94.72 |                 |                   |
| <b>accessories for</b>  | 380378  |                 |                   |
|  | <b>No.</b>  | 380804          | <b>Ref. No.</b> — |
|   | support bracket   |                 |                   |

## electronics

### PCBs



1

|                    |         |                 |          |
|--------------------|---------|-----------------|----------|
| <b>No.</b>         | 401606  | <b>Ref. No.</b> | RI00A031 |
| <b>description</b> | display |                 |          |

### time relays

#### time relays



1

|                    |   |                 |          |
|--------------------|---|-----------------|----------|
| <b>No.</b>         | 380770  | <b>Ref. No.</b> | RF000555 |
| <b>description</b> | time relay connection plug-in connection round 8-pole |                 |          |

## solenoïd valves

### solenoïd valves (water)

TP



1





|   |  |                 |                   |
|---|--|-----------------|-------------------|
| <b>No.</b>  | 370019   | <b>Ref. No.</b> | RF000625          |
| <b>description</b>  | solenoid valve double angled 230VAC inlet 3/4" outlet 11.5mm DN10 TP plastic |                 |                   |
| <b>spare parts for</b>  | 370019   |                 |                   |
|  | <b>No.</b>   | 371013          | <b>Ref. No.</b> — |
|   | solenoid coil TP 230VAC 50/60Hz  |                 |                   |
| <b>accessories for</b>  | 370019   |                 |                   |
|  | <b>No.</b>   | 371220          | <b>Ref. No.</b> — |
|   | reducer TP flow rate 3l/min red tolerance ±15%                               |                 |                   |
|  | <b>No.</b>   | 371221          | <b>Ref. No.</b> — |
|   | reducer TP flow rate 5.5l/min yellow tolerance ±15%                          |                 |                   |
|  | <b>No.</b>   | 371222          | <b>Ref. No.</b> — |
|   | reducer TP flow rate 6l/min grey tolerance ±15%                              |                 |                   |

Table continues on next page



solenoid valves (refrigeration)

CASTEL

valves



1

|                    |   |                 |          |
|--------------------|---|-----------------|----------|
| <b>No.</b>         | 370567  | <b>Ref. No.</b> | RF000532 |
| <b>description</b> | solenoid valve angled type 1018/M617A6 230V p max 35bar connection 6mm soldering connection -35 up to 110°C CASTEL 50/60Hz cable length 600mm |                 |          |

valve bodies





STANDARD series













suitable for refrigerants R22, R134a, R404A, R407C, R410A, R507



1

|                    |   |                 |          |
|--------------------|---|-----------------|----------|
| <b>No.</b>         | 370151  | <b>Ref. No.</b> | RF000557 |
| <b>description</b> | solenoid valve body NC type 1028/2 S p max 45bar connection 1/4" soldering connection DN 2.2mm -35 up to +105°C L 125mm refrigeration straight CASTEL |                 |          |

|   |  |        |                 |   |
|---|--|--------|-----------------|---|
| <b>accessories for</b>  | 370151   |        |                 |   |
|  | <b>No.</b>   | 371084 | <b>Ref. No.</b> | — |
|   | solenoid coil CASTEL 230VAC 8VA 50/60Hz connection cable 1000mm type CM2             |        |                 |   |
|  | <b>No.</b>   | 371090 | <b>Ref. No.</b> | — |
|   | power socket plug type DIN 43650A screw  |        |                 |   |
|  | <b>No.</b>   | 371301 | <b>Ref. No.</b> | — |
|   | solenoid coil CASTEL 110VAC 8VA 50/60Hz seat ø 11.5mm connection DIN 43650A type HF2 |        |                 |   |
|  | <b>No.</b>   | 371314 | <b>Ref. No.</b> | — |
|   | solenoid coil CASTEL 240VAC 8VA 50/60Hz seat ø 11.5mm                                |        |                 |   |
|  | <b>No.</b>   | 371321 | <b>Ref. No.</b> | — |
|   | solenoid coil CASTEL 12/24VAC 50/60Hz seat ø 11.5mm connection DIN 43650A type HF2   |        |                 |   |

|   |  |        |                 |   |
|---|--|--------|-----------------|---|
| <b>accessories for</b>  | 370019   |        |                 |   |
|    | <b>No.</b>   | 371223 | <b>Ref. No.</b> | — |
|   | reducer TP flow rate 10l/min white tolerance ±15%        |        |                 |   |
|    | <b>No.</b>   | 371224 | <b>Ref. No.</b> | — |
|   | reducer TP flow rate 12l/min bronze tolerance ±15%       |        |                 |   |
|    | <b>No.</b>   | 371225 | <b>Ref. No.</b> | — |
|   | reducer TP flow rate 16l/min light brown tolerance ±15%  |        |                 |   |
|    | <b>No.</b>   | 371226 | <b>Ref. No.</b> | — |
|   | reducer TP flow rate 20l/min red tolerance ±15%          |        |                 |   |
|    | <b>No.</b>   | 371230 | <b>Ref. No.</b> | — |
|   | reducer TP flow rate 0.25l/min red tolerance ±25%        |        |                 |   |
|    | <b>No.</b>   | 371231 | <b>Ref. No.</b> | — |
|   | reducer TP flow rate 0.35l/min violet tolerance ±25%     |        |                 |   |
|    | <b>No.</b>   | 371232 | <b>Ref. No.</b> | — |
|   | reducer TP flow rate 0.5l/min orange tolerance ±25%      |        |                 |   |
|    | <b>No.</b>   | 371233 | <b>Ref. No.</b> | — |
|   | reducer TP flow rate 0.8l/min white tolerance ±25%       |        |                 |   |
|    | <b>No.</b>   | 371234 | <b>Ref. No.</b> | — |
|   | reducer TP flow rate 1l/min light blue tolerance ±25%    |        |                 |   |
|   | <b>No.</b>   | 371235 | <b>Ref. No.</b> | — |
|   | reducer TP flow rate 1.2l/min brown tolerance ±25%       |        |                 |   |
|  | <b>No.</b>   | 371236 | <b>Ref. No.</b> | — |
|   | reducer TP flow rate 1.5l/min light brown tolerance ±25% |        |                 |   |
|  | <b>No.</b>   | 371237 | <b>Ref. No.</b> | — |
|   | reducer TP flow rate 2.5l/min yellow tolerance ±25%      |        |                 |   |
|  | <b>No.</b>   | 371238 | <b>Ref. No.</b> | — |
|   | reducer TP flow rate 3.4l/min dark green tolerance ±25%  |        |                 |   |
|  | <b>No.</b>   | 371239 | <b>Ref. No.</b> | — |
|   | reducer TP flow rate 5l/min black tolerance ±25%         |        |                 |   |
|  | <b>No.</b>   | 371240 | <b>Ref. No.</b> | — |
|   | reducer TP flow rate 8l/min blue tolerance ±20%          |        |                 |   |

solenoid valves with reducers



1

|                    |   |                 |          |
|--------------------|---|-----------------|----------|
| <b>No.</b>         | 370401  | <b>Ref. No.</b> | RF000624 |
| <b>description</b> | solenoid valve single angled 230VAC inlet 3/4" outlet 11.5mm output 2.5l/min t.max. 90°C TP plastic flow regulating valve outlet yellow |                 |          |





CEME

valves

with pipe clamp



|                    |   |                 |          |
|--------------------|---|-----------------|----------|
| <b>No.</b>         | 370408  | <b>Ref. No.</b> | RF00B770 |
| <b>description</b> | solenoid valve straight CEME type 6807 230V pressure range 0.1-25bar DN2.5 connection 6mm soldering connection -45 up to +125°C refrigeration |                 |          |

various

valves



|                    |  |                 |                      |
|--------------------|--|-----------------|----------------------|
| <b>No.</b>         | 370406   | <b>Ref. No.</b> | RF000531<br>RF000532 |
| <b>description</b> | solenoid valve angled type 5925 p max 25bar DN1.5 connection 6mm soldering connection -45 up to +125°C CEME refrigeration 230V |                 |                      |



|                    |   |                 |          |
|--------------------|---|-----------------|----------|
| <b>No.</b>         | 370407  | <b>Ref. No.</b> | RF000532 |
| <b>description</b> | solenoid valve angled type 5925 pressure range 0.1-25bar DN2.0 connection 6mm soldering connection -45 up to +125°C CEME refrigeration 230V |                 |          |

pressure switches

for refrigeration

SAGI NO MIYA



|                    |  |                 |          |
|--------------------|--|-----------------|----------|
| <b>No.</b>         | 541120   | <b>Ref. No.</b> | RF000621 |
| <b>description</b> | pressure control HD reset automatic refrigeration type HTB-X3028 connection male faston 6.3mm switch-on pressure 17bar |                 |          |

compressors

ACC/ZEL

R404a/R507

HMBP monophase

High/Medium evaporation temperature above -20/-15 °C



|                    |   |                 |          |
|--------------------|---|-----------------|----------|
| <b>No.</b>         | 605020  | <b>Ref. No.</b> | RB00A795 |
| <b>description</b> | compressor coolant R404a/R507 type ML40TB 220-240V 50Hz HMBP fully hermetic 10kg 1/6HP cylinder capacity 4.04cm <sup>3</sup> CSIR H 175.5mmW 168W 218W 276W 342W 416W 499W 589W 688W test method ASHRAE |                 |          |



|                    |  |                 |            |
|--------------------|--|-----------------|------------|
| <b>No.</b>         | 605068   | <b>Ref. No.</b> | RB00B133/1 |
| <b>description</b> | compressor coolant R404a/R507 type ML45TB 220-240V 50Hz HMBP fully hermetic 10kg 1/5HP cylinder capacity 4.5cm <sup>3</sup> CSIR H 175.5mmW 192W 246W 309W 382W 465W 557W 659W 771W test method ASHRAE |                 |            |



|                    |  |                 |          |
|--------------------|--|-----------------|----------|
| <b>No.</b>         | 605074   | <b>Ref. No.</b> | RB00B369 |
| <b>description</b> | compressor coolant R404a/R507 type ML60TG 220-240V 50Hz HMBP fully hermetic 10kg 1/4HP cylinder capacity 5.7cm <sup>3</sup> CSIR H 191.1mmW 218W 286W 365W 457W 562W 678W 807W 947W test method ASHRAE |                 |          |



1

|                    |  |                 |          |
|--------------------|--|-----------------|----------|
| <b>No.</b>         | 605014   | <b>Ref. No.</b> | RB00A797 |
| <b>description</b> | compressor coolant R404a/R507 type ML80TB 220-240V 50Hz HMBP fully hermetic 11.4kg 3/8HP cylinder capacity 7.57cm <sup>3</sup> CSIR H 175.5mmW 261W 346W 446W 561W 691W 835W 993W 1167W test method ASHRAE ambient temperature max. 43°C |                 |          |



1

|                    |   |                 |          |
|--------------------|---|-----------------|----------|
| <b>No.</b>         | 605029  | <b>Ref. No.</b> | RB00B149 |
| <b>description</b> | compressor coolant R404a/R507 type MP12RB 220-240V 50Hz HMBP fully hermetic 13.5kg 1/2HP cylinder capacity 12cm <sup>3</sup> CSIR H 203.6mmW 561W 734W 933W 1157W 1407W 1681W 1982WW test method ASHRAE ambient temperature max. 43°C |                 |          |



1

|                    |   |                 |          |
|--------------------|---|-----------------|----------|
| <b>No.</b>         | 605028  | <b>Ref. No.</b> | RB00A798 |
| <b>description</b> | compressor coolant R404a/R507 type ML90TB 220-240V 50Hz HMBP fully hermetic 11.6kg 3/8HP cylinder capacity 8.85cm <sup>3</sup> CSIR H 175.5mmW 323W 418W 532W 666W 819W 990W 1181W 1391W test method ASHRAE ambient temperature max. 43°C |                 |          |

EMBRACO / ASPERA

R404a/R507

HMBP monophase

High/Medium evaporation temperature above -20/-15 °C



1

|                    |   |                 |          |
|--------------------|---|-----------------|----------|
| <b>No.</b>         | 605030  | <b>Ref. No.</b> | RB00B162 |
| <b>description</b> | compressor coolant R404a/R507 type NJ9226GK 220-240V 50Hz HMBP fully hermetic 20.8kg 1HP cylinder capacity 21.7cm <sup>3</sup> CSIR H 265mmW 1363W 1764W 2249W 2819W 3472W 4210W 5032W test method ASHRAE |                 |          |

CUBIGEL

R404a/R507

HMBP monophase

High/Medium evaporation temperature above -20/-15 °C



1

|                    |   |                 |                      |
|--------------------|---|-----------------|----------------------|
| <b>No.</b>         | 605013  | <b>Ref. No.</b> | RB00A796<br>RB00B369 |
| <b>description</b> | compressor coolant R404a/R507 type ML60TB 220-240V 50Hz HMBP fully hermetic 10.1kg 1/4HP power input 647W cylinder capacity 5.68cm <sup>3</sup> CSIR H 175.5mmW 244W 319W 407W 511W 628W 760W 906W 1067W test method ASHRAE |                 |                      |



L'UNITE HERMETIQUE / TECUMSEH

R404A  
HMBP monophase

High/Medium evaporation temperature above -20/-15 °C



1

|   |  |                 |                   |
|---|--|-----------------|-------------------|
| <b>No.</b>  | 605025   | <b>Ref. No.</b> | RB00B620          |
| <b>description</b>  | compressor coolant R404A type AE4430Z-FZ 220-240V 50Hz HMBP fully hermetic 10.2kg 1/4HP power input 427W cylinder capacity 5.7cm <sup>3</sup> CSIR H 186mmWW 258W 346W 441W 550W 682W 794W test method EN 12900 908W |                 |                   |
| <b>spare parts for</b>  | 605025   |                 |                   |
|  | <b>No.</b>   | 380061          | <b>Ref. No.</b> — |
|   | start relay MTRP0027-31 120/240V voltage AC 8A 1NO   |                 |                   |



1

|                    |  |                 |          |
|--------------------|--|-----------------|----------|
| <b>No.</b>         | 605023   | <b>Ref. No.</b> | RB00A798 |
| <b>description</b> | compressor coolant R404A type AE4450Z 220-240V 50Hz HMBP fully hermetic 12.5kg 3/8HP cylinder capacity 8.85cm <sup>3</sup> CSIR H 207mmWW 434W 567W 734W 927W 1270W 1367W test method EN 12900 1729W |                 |          |



1

|                    |  |                 |          |
|--------------------|--|-----------------|----------|
| <b>No.</b>         | 605021   | <b>Ref. No.</b> | RB00B133 |
| <b>description</b> | compressor coolant R404A type AEZ4425Z 220-240V 50Hz HMBP fully hermetic 9.8kg 1/5HP cylinder capacity 4.5cm <sup>3</sup> CSIR H 186mmWW 198W 263W 341W 432W 537W 629W test method EN 12900 723W |                 |          |



1

|                    |  |                 |          |
|--------------------|--|-----------------|----------|
| <b>No.</b>         | 605022   | <b>Ref. No.</b> | RB000440 |
| <b>description</b> | compressor coolant R404A type AEZ4440Z 230V 50Hz HMBP fully hermetic 21kg cylinder capacity 7.55cm <sup>3</sup> CSIR H 292mm 415W 517W 637W 772W 919W 1074W test method EN 12900 1234W |                 |          |

fans

refrigeration fans

- refrigeration motors universal
- ebm-papst
- miscellaneous



1

|   |   |                 |                      |
|---|---|-----------------|----------------------|
| <b>No.</b>  | 601405  | <b>Ref. No.</b> | RC000451<br>RD00B934 |
| <b>description</b>  | fan motor M4Q045-CA01-19 7W 230V 50Hz W 83mm                                  |                 |                      |
| <b>spare parts for</b>  | 601405  |                 |                      |
|  | <b>No.</b>  | 601413          | <b>Ref. No.</b> —    |
|   | fixing plate suitable for fanwheel ED ø 32mm shaft ø 7 mounting distance 26mm |                 |                      |



ELCO





N series - multi fit



|            |        |                 |          |
|------------|--------|-----------------|----------|
| <b>No.</b> | 601427 | <b>Ref. No.</b> | RC000452 |
|------------|--------|-----------------|----------|

**description** fan motor ELCO 10W 230V 50/60Hz bearing slide bearing L1 49mm L2 59mm L3 86.5mm W 83mm connection cable 500mm 1300/1550rpm 5 mounting options VNT10-20/028

**spare parts for** 601427

|  |            |        |                 |   |
|--|------------|--------|-----------------|---|
|   | <b>No.</b> | 560140 | <b>Ref. No.</b> | — |
| hexagonal nut thread M4 H 4.8mm SS WS 7 Qty 20 pcs DIN/ISO DIN 985 self-locking    |            |        |                 |   |
|   | <b>No.</b> | 560332 | <b>Ref. No.</b> | — |
| plain washer ID ø 4.3mm ED ø 9mm thickness 0.8mm SS Qty 1 pcs                      |            |        |                 |   |
|   | <b>No.</b> | 560340 | <b>Ref. No.</b> | — |
| hexagonal nut thread M4 H 3.2mm WS 7 SS DIN/ISO DIN 934 / ISO 4032/8673 Qty 1 pcs  |            |        |                 |   |
|  | <b>No.</b> | 601413 | <b>Ref. No.</b> | — |
| fixing plate suitable for fanwheel ED ø 32mm shaft ø 7 mounting distance 26mm      |            |        |                 |   |

N series - standard



|            |        |                 |          |
|------------|--------|-----------------|----------|
| <b>No.</b> | 601527 | <b>Ref. No.</b> | RC00A807 |
|------------|--------|-----------------|----------|

**description** fan motor 16W 230V 50/60Hz W 84mm 1300rpm VN16-38

IMPORT

multi fit fan motors



|            |        |                 |          |
|------------|--------|-----------------|----------|
| <b>No.</b> | 601022 | <b>Ref. No.</b> | RD000512 |
|------------|--------|-----------------|----------|

**description** fan motor 10W 230V 50-60Hz L1 44mm L2 54mm L3 85mm W 84mm cable length 500mm 1300rpm YZF10-20-18/26 5 mounting options bearing slide bearing



|            |        |                 |          |
|------------|--------|-----------------|----------|
| <b>No.</b> | 601023 | <b>Ref. No.</b> | RD000513 |
|------------|--------|-----------------|----------|

**description** fan motor 16W 230V 50-60Hz L1 45mm L2 61mm L3 92mm W 84mm cable length 500mm 1300rpm YZF16-25-18/26 5 mounting options bearing slide bearing



|            |        |                 |          |
|------------|--------|-----------------|----------|
| <b>No.</b> | 601020 | <b>Ref. No.</b> | RD000511 |
|------------|--------|-----------------|----------|

**description** fan motor 5W 230V 50-60Hz L1 44mm L2 48mm L3 79mm W 84mm cable length 500mm 1300rpm YZF5-13-18/26 5 mounting options bearing slide bearing



accessories

fan wheels

aluminium

1

|                    |  |                 |          |
|--------------------|--|-----------------|----------|
| <b>No.</b>         | 601069   | <b>Ref. No.</b> | RD000518 |
| <b>description</b> | fan wheel sucking $\varnothing$ 172mm turn direction left fan wheel mounting 25.4mm blade angle 25° W 32mm aluminium |                 |          |

1

|                    |  |                 |          |
|--------------------|--|-----------------|----------|
| <b>No.</b>         | 601070   | <b>Ref. No.</b> | RD000519 |
| <b>description</b> | fan wheel sucking $\varnothing$ 200mm fan wheel mounting 25.4mm blade angle 28° W 38mm aluminium |                 |          |

1

|                    |  |                 |          |
|--------------------|--|-----------------|----------|
| <b>No.</b>         | 601071   | <b>Ref. No.</b> | RD000520 |
| <b>description</b> | fan wheel sucking $\varnothing$ 230mm fan wheel mounting 25.4mm blade angle 25° W 37mm aluminium |                 |          |

1

|                    |  |                 |                      |
|--------------------|--|-----------------|----------------------|
| <b>No.</b>         | 601409   | <b>Ref. No.</b> | RD000521<br>RD00A629 |
| <b>description</b> | fan wheel sucking $\varnothing$ 254mm fan wheel mounting 25.4mm blade angle 25° W 38mm aluminium |                 |                      |

1

|                    |  |                 |          |
|--------------------|--|-----------------|----------|
| <b>No.</b>         | 601410   | <b>Ref. No.</b> | RD000499 |
| <b>description</b> | fan wheel sucking $\varnothing$ 300mm fan wheel mounting 25.4mm blade angle 28° W 45mm aluminium |                 |          |

cold air circulating fans (complete)

COPREL

AX series

1

|   |  |                 |                      |   |
|---|--|-----------------|----------------------|---|
| <b>No.</b>  | 601078   | <b>Ref. No.</b> | RD000508<br>RD000510 |   |
| <b>description</b>  | fan blowing 230V 18W 50Hz fan wheel $\varnothing$ 130mm shaft L 21mm feet depth 29mm connection left |                 |                      |   |
| <b>spare parts for</b>  | 601078   |                 |                      |   |
|  | <b>No.</b>   | 510923          | <b>Ref. No.</b>      | — |
| clamping ring for shaft $\varnothing$ 10mm ID $\varnothing$ 9.4mm H 6mm             |  |                 |                      |   |

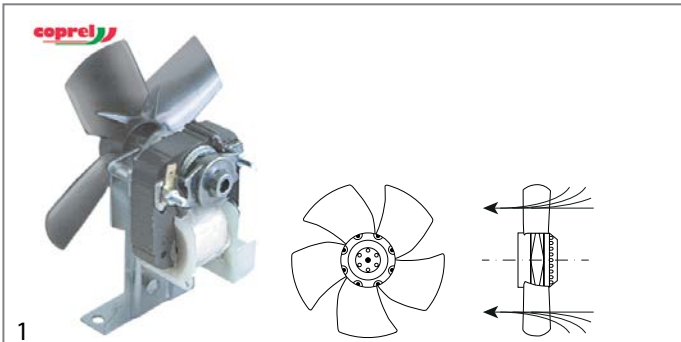

**1**

|                    |   |                 |          |
|--------------------|---|-----------------|----------|
| <b>No.</b>         | 601079  | <b>Ref. No.</b> | RD000509 |
| <b>description</b> | fan sucking 230V 18W 50Hz fan wheel ø 130mm shaft L 20mm feet depth 31mm connection right |                 |          |

miscellaneous

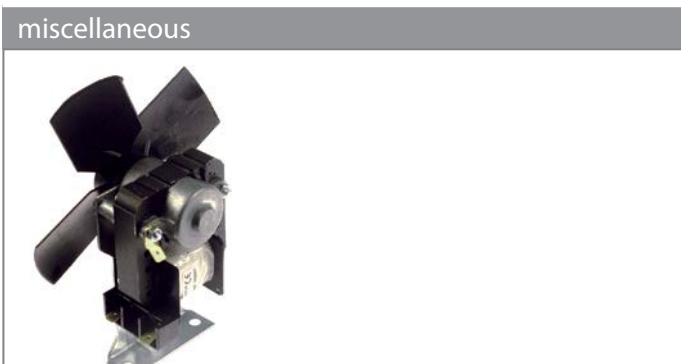

**1**

|                    |          |                 |          |
|--------------------|----------|-----------------|----------|
| <b>No.</b>         | 601411   | <b>Ref. No.</b> | RD000508 |
| <b>description</b> | fan 230V |                 |          |

**motors**

gear motors

for ice-cube maker

for paddles



**1**

|                    |   |                 |                             |
|--------------------|---|-----------------|-----------------------------|
| <b>No.</b>         | 500407  | <b>Ref. No.</b> | 926061<br>RG000636<br>RG636 |
| <b>description</b> | gear motor LIP type 123MR 8W 220/240V voltage AC 50/60Hz 50rpm turn direction counterclockwise shaft ø 4mm shaft intake ø 6.2mm groove width 2.3mm shaft L 8mm shaft ø 4mm W 74mm |                 |                             |

for sumps



**1**

|                    |  |                 |          |
|--------------------|--|-----------------|----------|
| <b>No.</b>         | 500412   | <b>Ref. No.</b> | RG000640 |
| <b>description</b> | gear motor LIP type 021B 11W 230V 50Hz 1rpm shaft ø 7mm shaft length 20mm W 74mm D 67mm H 110mm for sump |                 |          |



**1**

|                    |   |                 |                      |
|--------------------|---|-----------------|----------------------|
| <b>No.</b>         | 500688  | <b>Ref. No.</b> | RG000640<br>RG00A684 |
| <b>description</b> | gear motor LIP type 068 11W 230V voltage AC 50Hz 1rpm shaft ø 7mm shaft length 20mm W 75mm D 80mm H 110mm for sump shaft with transverse hole |                 |                      |

miscellaneous



**1**

|                    |                 |                 |          |
|--------------------|-----------------|-----------------|----------|
| <b>No.</b>         | 500788          | <b>Ref. No.</b> | RG000650 |
| <b>description</b> | gear motor 230V |                 |          |

**motors**

for ice-cube maker

complete



**1**

|                    |   |                 |          |
|--------------------|---|-----------------|----------|
| <b>No.</b>         | 500787  | <b>Ref. No.</b> | RG000647 |
| <b>description</b> | motor 180W 230V 50/60Hz 1 phase shaft ø 12.8mm 1300rpm RPM 0.18kW |                 |          |



## electric accessories

### terminals

connection terminals with screw/faston connections



1

|                    |  |                 |          |
|--------------------|--|-----------------|----------|
| <b>No.</b>         | 550411   | <b>Ref. No.</b> | RI000709 |
| <b>description</b> | power terminal block 6-pole max. 40A max 450V connection $\phi 6\text{mm}^2$ / F6.3 temp.-resist. 150°C cross section 6mm <sup>2</sup> |                 |          |

## equipment-specific units

### for ice-cube maker

#### ice chutes

##### slide grates



1

|                    |   |                 |                    |
|--------------------|---|-----------------|--------------------|
| <b>No.</b>         | 692097  | <b>Ref. No.</b> | RN00A017<br>RNA017 |
| <b>description</b> | slide grate for ice-cube maker L 160mm W 170mm H 60mm |                 |                    |

#### gearboxes

1

|                    |         |                 |          |
|--------------------|---------|-----------------|----------|
| <b>No.</b>         | 695383  | <b>Ref. No.</b> | RG000649 |
| <b>description</b> | gearbox |                 |          |



1

|                    |  |                 |          |
|--------------------|--|-----------------|----------|
| <b>No.</b>         | 695382   | <b>Ref. No.</b> | RG000646 |
| <b>description</b> | gearbox H 140mm L 160mm W 150mm shaft L 23mm drive shaft $\phi$ 11.5mm |                 |          |

#### doors

##### doors



1

|                    |                              |                 |          |
|--------------------|------------------------------|-----------------|----------|
| <b>No.</b>         | 698942                       | <b>Ref. No.</b> | RP00A667 |
| <b>description</b> | door W 378mm H 245mm plastic |                 |          |

#### pan mechanics

##### sumps



1

|                    |  |                 |          |
|--------------------|--|-----------------|----------|
| <b>No.</b>         | 695358   | <b>Ref. No.</b> | RH00A004 |
| <b>description</b> | sump for ice maker L 180mm W 140mm H 60mm EUROFRIGOR white |                 |          |



1

|                    |  |                 |                    |
|--------------------|--|-----------------|--------------------|
| <b>No.</b>         | 695359   | <b>Ref. No.</b> | RH00A005<br>RHA005 |
| <b>description</b> | sump for ice maker L 180mm W 180mm H 60mm EUROFRIGOR |                 |                    |

|   |  |                 |                    |
|---|--|-----------------|--------------------|
|  |  |                 |                    |
| 1   |  |                 |                    |
| <b>No.</b>  | 695360   | <b>Ref. No.</b> | RH00A006<br>RHA006 |
| <b>description</b>  | sump for ice maker L 180mm W 245mm H 60mm EUROFRIGOR white |                 |                    |

|   |   |                 |          |
|---|---|-----------------|----------|
|  |   |                 |          |
| 1   |   |                 |          |
| <b>No.</b>  | 695361                                    | <b>Ref. No.</b> | RM00A050 |
| <b>description</b>  | sump for ice maker L 330mm W 195mm H 60mm |                 |          |

|   |   |                 |          |
|---|---|-----------------|----------|
|  |   |                 |          |
| 1   |   |                 |          |
| <b>No.</b>  | 695362                                    | <b>Ref. No.</b> | RM00A079 |
| <b>description</b>  | sump for ice maker L 465mm W 200mm H 70mm |                 |          |

|  |   |                 |          |
|--|---|-----------------|----------|
|  |   |                 |          |
| 1  |   |                 |          |
| <b>No.</b>   | 695363                                    | <b>Ref. No.</b> | RM00A047 |
| <b>description</b>   | sump for ice maker L 690mm W 200mm H 70mm |                 |          |

spare parts and accessories

|   |   |                 |          |
|---|---|-----------------|----------|
|  |   |                 |          |
| 1   |   |                 |          |
| <b>No.</b>  | 695376  | <b>Ref. No.</b> | RQ001152 |
| <b>description</b>  | adjusting ring for spindle H 7mm ID ø 6mm ED ø 12mm thread M4 stainless steel |                 |          |

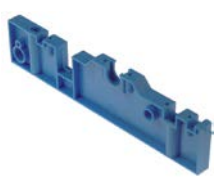
|   |                  |                 |          |
|---|------------------|-----------------|----------|
|  |                  |                 |          |
| 1   |                  |                 |          |
| <b>No.</b>  | 695364           | <b>Ref. No.</b> | RH003616 |
| <b>description</b>  | bracket for sump |                 |          |

|   |                  |                 |          |
|---|------------------|-----------------|----------|
|  |                  |                 |          |
| 1   |                  |                 |          |
| <b>No.</b>  | 695365           | <b>Ref. No.</b> | RQ003619 |
| <b>description</b>  | bush for impulse |                 |          |

|  |                       |                 |          |
|--|-----------------------|-----------------|----------|
|  |                       |                 |          |
| 1  |                       |                 |          |
| <b>No.</b>   | 695367                | <b>Ref. No.</b> | RH003618 |
| <b>description</b>   | lever for pan tilting |                 |          |

|   |  |                 |          |
|---|--|-----------------|----------|
|  |  |                 |          |
| 1   |  |                 |          |
| <b>No.</b>  | 695030                                       | <b>Ref. No.</b> | RH00A008 |
| <b>description</b>  | lever for pan tilting new edition EUROFRIGOR |                 |          |

|   |  |                 |                   |
|---|--|-----------------|-------------------|
|  |  |                 |                   |
| 1   |  |                 |                   |
| <b>No.</b>  | 695031                                       | <b>Ref. No.</b> | RH00669<br>RM1063 |
| <b>description</b>  | lever for pan tilting old edition EUROFRIGOR |                 |                   |

|  |  |                 |                   |
|--|--|-----------------|-------------------|
|  |  |                 |                   |
| 1  |  |                 |                   |
| <b>No.</b>   | 695032   | <b>Ref. No.</b> | RH000675<br>RH675 |
| <b>description</b>   | paddle short ø 135mm shaft intake ø 6mm shaft lengthmm 1 |                 |                   |

|   |                     |                 |          |
|---|---------------------|-----------------|----------|
|  |                     |                 |          |
| 1   |                     |                 |          |
| <b>No.</b>  | 695368              | <b>Ref. No.</b> | RQ003626 |
| <b>description</b>  | pin for pan tilting |                 |          |

|  |                                     |                 |          |
|--|-------------------------------------|-----------------|----------|
|  |                                     |                 |          |
| 1  |                                     |                 |          |
| <b>No.</b>   | 695369                              | <b>Ref. No.</b> | RQ003625 |
| <b>description</b>   | spindle for ice maker ø 6mm L 160mm |                 |          |

|  |                                     |                 |          |
|--|-------------------------------------|-----------------|----------|
|  |                                     |                 |          |
| 1  |                                     |                 |          |
| <b>No.</b>   | 695370                              | <b>Ref. No.</b> | RQ00A028 |
| <b>description</b>   | spindle for ice maker ø 6mm L 195mm |                 |          |

|  |                                     |                 |          |
|--|-------------------------------------|-----------------|----------|
|  |                                     |                 |          |
| 1  |                                     |                 |          |
| <b>No.</b>   | 695371                              | <b>Ref. No.</b> | RQ00A029 |
| <b>description</b>   | spindle for ice maker ø 6mm L 235mm |                 |          |







|   |                                     |                 |          |
|---|-------------------------------------|-----------------|----------|
| 1  |                                     |                 |          |
| <b>No.</b>  | 695378                              | <b>Ref. No.</b> | RQ000976 |
| <b>description</b>  | spindle for ice maker ø 6mm L 235mm |                 |          |

|   |                                     |                 |          |
|---|-------------------------------------|-----------------|----------|
| 1  |                                     |                 |          |
| <b>No.</b>  | 695372                              | <b>Ref. No.</b> | RQ00A030 |
| <b>description</b>  | spindle for ice maker ø 6mm L 300mm |                 |          |

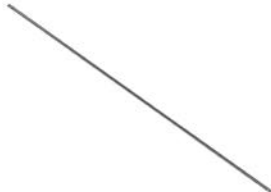
|   |                                     |                 |          |
|---|-------------------------------------|-----------------|----------|
| 1  |                                     |                 |          |
| <b>No.</b>  | 695373                              | <b>Ref. No.</b> | RQ00A062 |
| <b>description</b>  | spindle for ice maker ø 6mm L 380mm |                 |          |

|   |                                     |                 |          |
|---|-------------------------------------|-----------------|----------|
| 1  |                                     |                 |          |
| <b>No.</b>  | 695374                              | <b>Ref. No.</b> | RQ00A075 |
| <b>description</b>  | spindle for ice maker ø 6mm L 517mm |                 |          |

|   |                                     |                 |          |
|---|-------------------------------------|-----------------|----------|
| 1  |                                     |                 |          |
| <b>No.</b>  | 695375                              | <b>Ref. No.</b> | RQ00A063 |
| <b>description</b>  | spindle for ice maker ø 6mm L 742mm |                 |          |

|   |                         |                 |          |
|---|-------------------------|-----------------|----------|
| 1  |                         |                 |          |
| <b>No.</b>  | 695028                  | <b>Ref. No.</b> | RQ00A064 |
| <b>description</b>  | spindle for pan tilting |                 |          |

|   |   |                 |          |
|---|---|-----------------|----------|
| 1  |   |                 |          |
| <b>No.</b>  | 695029  | <b>Ref. No.</b> | RQ00A065 |
| <b>description</b>  | spindle for pan tilting ø 6mm length external size 31mm L 26mm EUROFRIGOR |                 |          |

|   |                               |                 |          |
|---|-------------------------------|-----------------|----------|
| 1  |                               |                 |          |
| <b>No.</b>  | 695366                        | <b>Ref. No.</b> | RH003620 |
| <b>description</b>  | wheel for pan tilting ø 100mm |                 |          |

drive technology

|   |   |                 |          |
|---|---|-----------------|----------|
| 1  |   |                 |          |
| <b>No.</b>  | 695384  | <b>Ref. No.</b> | RV003202 |
| <b>description</b>  | toothed belt disc disc ø 38mm shaft intake ø 13mm groove depth 5mm disc width 13mm groove width 10x10mm overall width 22mm splitting 5 shaft ø 23.5mm |                 |          |

|   |                                       |                 |          |
|---|---------------------------------------|-----------------|----------|
| 1  |                                       |                 |          |
| <b>No.</b>  | 695386                                | <b>Ref. No.</b> | RV003201 |
| <b>description</b>  | toothed belt disc large type ES40-100 |                 |          |

mechanics for evaporators

gear motors

motors

|  |   |                 |          |
|--|---|-----------------|----------|
| 1  |   |                 |          |
| <b>No.</b>   | 500787  | <b>Ref. No.</b> | RG000647 |
| <b>description</b>   | motor 180W 230V 50/60Hz 1 phase shaft ø 12.8mm 1300rpm RPM 0.18kW |                 |          |

hoses

formed hoses

straight

silicone hoses



|                    |   |                 |           |
|--------------------|---|-----------------|-----------|
| <b>No.</b>         | 530879  | <b>Ref. No.</b> | 913037210 |
| <b>description</b> | drain hose straight ID ø 19mm ED ø 24mm L 210mm |                 |           |

hose connectors

without thread



|                    |                |                 |                    |
|--------------------|----------------|-----------------|--------------------|
| <b>No.</b>         | 695055         | <b>Ref. No.</b> | RH003285+A716+B267 |
| <b>description</b> | hose connector |                 |                    |



|                    |                                   |                 |          |
|--------------------|-----------------------------------|-----------------|----------|
| <b>No.</b>         | 695054                            | <b>Ref. No.</b> | RH000665 |
| <b>description</b> | hose connector for ice-cube maker |                 |          |



|                    |                                   |                 |                    |
|--------------------|-----------------------------------|-----------------|--------------------|
| <b>No.</b>         | 695056                            | <b>Ref. No.</b> | RH003286+A716+B267 |
| <b>description</b> | hose connector for ice-cube maker |                 |                    |



|                    |  |                 |          |
|--------------------|--|-----------------|----------|
| <b>No.</b>         | 695057   | <b>Ref. No.</b> | RH001080 |
| <b>description</b> | hose connector hose ø 12mm L 100mm L-shape plastic |                 |          |

floats

float containers



|                    |                 |                 |          |
|--------------------|-----------------|-----------------|----------|
| <b>No.</b>         | 695070          | <b>Ref. No.</b> | RH000828 |
| <b>description</b> | float container |                 |          |



|                        |   |                 |          |
|------------------------|---|-----------------|----------|
| <b>No.</b>             | 695073  | <b>Ref. No.</b> | RH00B632 |
| <b>description</b>     | float container   |                 |          |
| <b>spare parts for</b> | 695073  |                 |          |
| <b>No.</b>             | 346872  | <b>Ref. No.</b> | RI000800 |
| <b>description</b>     | microswitch with lever 250V 0.1A 1CO connection male faston 6.3mm L 50mm ambient temperature max. 85°C mounting distance 22mm type D41X actuating force: 6g lever length 36mm |                 |          |

for ice crusher

V-belts



|                    |   |                 |          |
|--------------------|---|-----------------|----------|
| <b>No.</b>         | 695387  | <b>Ref. No.</b> | RV00A296 |
| <b>description</b> | V-belt pulley single disc ø 128mm shaft intake ø 14mm groove depth 14mm disc width 19mm groove width 4mm overall width 35mm aluminium |                 |          |

refrigeration cycle components

filter driers

miscellaneous



|                    |  |                 |          |
|--------------------|--|-----------------|----------|
| <b>No.</b>         | 750226   | <b>Ref. No.</b> | RF000546 |
| <b>description</b> | dryer size 20g ø 24mm L 117mm connection 6.2/6.3mm |                 |          |



## transmission technology and ball bearings

### ball bearings

#### deep-groove ball bearings 2RS



1

|                    |  |                 |          |
|--------------------|--|-----------------|----------|
| <b>No.</b>         | 523513   | <b>Ref. No.</b> | RV003322 |
| <b>description</b> | deep-groove ball bearing type 6205-2RS shaft $\varnothing$ 25mm ED $\varnothing$ 52mm W 15mm with sealing discs deep-groove ball bearing DIN 625-1 |                 |          |



1

|                    |   |                 |                    |
|--------------------|---|-----------------|--------------------|
| <b>No.</b>         | 523504  | <b>Ref. No.</b> | RV003647<br>RV3647 |
| <b>description</b> | deep-groove ball bearing type 626-2RS shaft $\varnothing$ 6mm ED $\varnothing$ 19mm W 6mm with sealing discs deep-groove ball bearing DIN 625-1 |                 |                    |

### drive belts

#### toothed belts



1

|                    |  |                 |                      |
|--------------------|--|-----------------|----------------------|
| <b>No.</b>         | 695388   | <b>Ref. No.</b> | RV003233<br>RV00B075 |
| <b>description</b> | toothed belt profile XL L 196mm H 2mm teeth 98 splitting rubber with textile insertion CODE 196XL W 10mm type BI 4 164 |                 |                      |

### springs

#### compression springs



1

|                    |   |                 |          |
|--------------------|---|-----------------|----------|
| <b>No.</b>         | 695034  | <b>Ref. No.</b> | RR003629 |
| <b>description</b> | compression spring $\varnothing$ 10mm L 35mm wire gauge $\varnothing$ 1.7mm |                 |          |

## hoses

### drain hoses



1

|                    |  |                 |          |
|--------------------|--|-----------------|----------|
| <b>No.</b>         | 530726   | <b>Ref. No.</b> | RH001181 |
| <b>description</b> | drain hose DN19 L 1530mm A int. $\varnothing$ 19mm A ext. $\varnothing$ 23mm B int. $\varnothing$ 22mm B ext. $\varnothing$ 28mm outer hose $\varnothing$ 24mm |                 |          |



1

|                    |   |                 |          |
|--------------------|---|-----------------|----------|
| <b>No.</b>         | 530724  | <b>Ref. No.</b> | RH001180 |
| <b>description</b> | drain hose DN19 L 180mm A int. $\varnothing$ 19mm A ext. $\varnothing$ 27mm B int. $\varnothing$ 19mm B ext. $\varnothing$ 27mm outer hose $\varnothing$ 24mm |                 |          |



1

|                    |   |                 |          |
|--------------------|---|-----------------|----------|
| <b>No.</b>         | 530727  | <b>Ref. No.</b> | RH001177 |
| <b>description</b> | drain hose DN19 L 280mm A int. $\varnothing$ 19mm A ext. $\varnothing$ 27mm B int. $\varnothing$ 19mm B ext. $\varnothing$ 27mm outer hose $\varnothing$ 24mm |                 |          |



1

|                    |  |                 |          |
|--------------------|--|-----------------|----------|
| <b>No.</b>         | 530725   | <b>Ref. No.</b> | RH001176 |
| <b>description</b> | drain hose L 210mm A int. $\varnothing$ 19mm B int. $\varnothing$ 19mm outer hose $\varnothing$ 24mm |                 |          |



1

|                    |  |                 |          |
|--------------------|--|-----------------|----------|
| <b>No.</b>         | 530728   | <b>Ref. No.</b> | RH001182 |
| <b>description</b> | drain hose L 270mm A int. $\varnothing$ 19mm A ext. $\varnothing$ 27mm B int. $\varnothing$ 19mm B ext. $\varnothing$ 27mm outer hose $\varnothing$ 24mm |                 |          |



1

|                    |   |                 |          |
|--------------------|---|-----------------|----------|
| <b>No.</b>         | 530722  | <b>Ref. No.</b> | RH001175 |
| <b>description</b> | drain hose DN19 L 180mm straight $\varnothing$ inside 19mm straight ext. $\varnothing$ 25mm elbow $\varnothing$ inside 21mm elbow ext. $\varnothing$ 27mm outer hose $\varnothing$ 24mm |                 |          |

1

## fastening material

## screws

## grub screws

## miscellaneous



1

|                    |   |                 |                    |
|--------------------|---|-----------------|--------------------|
| <b>No.</b>         | 560458  | <b>Ref. No.</b> | RR003646<br>RR3646 |
| <b>description</b> | grub screw thread M4 L 5mm intake slotted Qty 1 pcs |                 |                    |

## fasteners

## retaining rings

## DIN 6799



1

|                    |   |                 |        |
|--------------------|---|-----------------|--------|
| <b>No.</b>         | 528709  | <b>Ref. No.</b> | RR3644 |
| <b>description</b> | retaining ring E D1 ø 4mm D2 ø 9mm steel DIN 6799 thickness 0.7mm for shaft ø 5-7mm |                 |        |

## roll pins



1

|                    |                       |                 |          |
|--------------------|-----------------------|-----------------|----------|
| <b>No.</b>         | 692013                | <b>Ref. No.</b> | RR003645 |
| <b>description</b> | roll pin ø 3mm L 16mm |                 |          |