

Professionall

Solutii profesionale pentru echipamente profesionale



GAS COMPONENTS



ELECTRIC COMPONENTS



WATER TECHNOLOGY



MECHANICAL COMPONENTS



TOOLS

Spare parts suitable for

ERRE2



heating elements

immersion heating elements

3 hole flange ø57.5mm

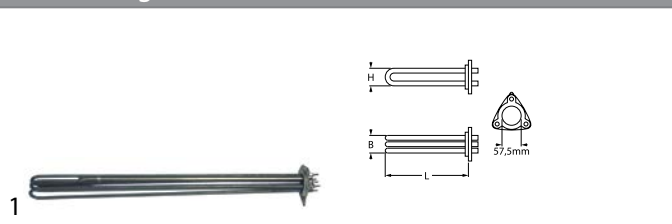

No.	416126	Ref. No.	293200360
description	heating element 10500W 230V mounting ø 57.5mm heating circuits 3 L 590mm W 30mm H 40mm number of thermostat sleeves 1 thermostat sleeves ø 7mm length thermostat sleeves 480mm thermostat sleeve upper tube ø 8.5mm hole distance 73mm hole ø 10mm connection M4 3 hole flange immersion heater		
spare parts for	416126		
	No.	510409	Ref. No. —
	O-ring EPDM thickness 5.34mm ID ø 56.52mm Qty 1 pcs		

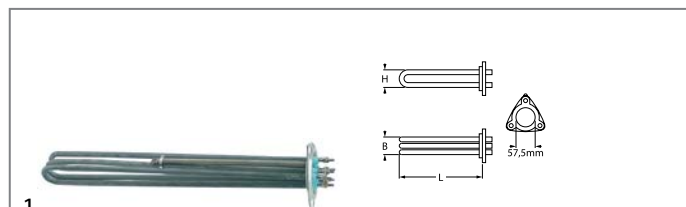

No.	416125	Ref. No.	293200760
description	heating element 7500W 230V mounting ø 57.5mm heating circuits 3 L 398mm W 36mm H 41mm number of thermostat sleeves 1 thermostat sleeves ø 7mm length thermostat sleeves 212mm thermostat sleeve not clinging tube ø 8.5mm hole distance 72mm hole ø 8mm connection M4 3 hole flange immersion heater		

heating elements for convection



No.	416119	Ref. No.	238200212 284201560
description	heating element 2000W 240V heating circuits 1 ID ø 182mm ED ø 195mm L 245mm H 34mm L1 43mm W1 30mm H1 10mm H2 24mm flange length 70mm flange width 22mm hole distance 56mm connection male faston 6.3mm connection length 56mm tube ø 6.3mm convection heating element mounting thread M5 rectangular flange with thread bolt		
accessories for	416119		
	No.	510368	Ref. No. —
	gasket L 70mm W 23.5mm hole ø 5mm hole distance 56mm FIBER thickness 2mm for heating element		

thermostats

control and safety thermostats

EGO

control thermostats

55.34_ series



No.	375192	Ref. No.	00402
description	thermostat t.max. 300°C temperature range 50-300°C 3-pole 3NO 16A probe ø 3mm probe L 219mm capillary pipe 900mm capillary pipe isolatedmm gland nut shaft ø 6x4.6mm shaft L 23mm shaft position upper rotation 270°		

lamps

screw-on/push-on fit

halogen lamp

for socket G4 / G6.35 / G9



No.	357193	Ref. No.	6242122001
description	halogen lamp socket G4 12V 20W temp.-resist. 300°C OSRAM HALOSTAR OVEN		

oven lamps

lamps

halogen lamps

for socket G4 / G6.35 / G9



No.	357193	Ref. No.	6242122001
description	halogen lamp socket G4 12V 20W temp.-resist. 300°C OSRAM HALOSTAR OVEN		

electric components



probes

producer-specific probes

core probes



No.	400263	Ref. No.	N/A
description	core temperature probe Pt100 cable PTFE probe -40 up to +250°C cable -40 up to +250°C connection 2-wire probe ø4x100mm thread cable length 2m handle ø 10mm handle length 90mm		

gas burners

hob burners

producer-specific hob burners

ERRE2

50, 60, 62, 70, 90, 92, 110 (old series)





No.	105068	Ref. No.	741312350
description	air mixing sleeve		
accessories for	105068		
	No. 104091	Ref. No.	790300799
	burner head D ø 124mm for burner cap ø 80mm suitable for 50, 90, 92, 110 series (old)		
	No. 104093	Ref. No.	270200170 770324790
	venturi C/D		
	No. 104096	Ref. No.	241202412
	burner holder with nozzle holder connection M20x1.5		
	No. 105060	Ref. No.	760305080 764305190
	burner head C for burner cap ø 60mm suitable for 60, 62 series		
	No. 105062	Ref. No.	760311640
	venturi C		
	No. 105076	Ref. No.	790300789
	burner head C for burner cap ø 60mm suitable for 70, 90, 92 series (old)		
	No. 105079	Ref. No.	770336760
	burner head D ø 100mm		
	No. 105091	Ref. No.	770339300
	burner head C for burner cap ø 60mm		
	No. 105098	Ref. No.	770336750
	burner head D for burner cap ø 80mm		
	No. 105099	Ref. No.	A00419
	burner head A for burner cap ø 110mm		
	No. 105100	Ref. No.	A00418
	burner head A for burner cap ø 110mm		

accessories for	105068		
	No. 105119	Ref. No.	A00420
	burner head B for burner cap ø 90mm		
	No. 105707	Ref. No.	—
	burner cap ø 95mm		
	No. 105708	Ref. No.	—
	burner head for burner cap ø 95mm		
	No. 105709	Ref. No.	—
	venturi		
	No. 105710	Ref. No.	—
	burner holder with nozzle holder		

accessories for	105078		
	No. 105078	Ref. No.	290200450
description	burner cap C ø 60mm		
accessories for	105078		
	No. 104093	Ref. No.	270200170 770324790
	venturi C/D		
	No. 104096	Ref. No.	241202412
	burner holder with nozzle holder connection M20x1.5		
	No. 105068	Ref. No.	741312350
	air mixing sleeve		
	No. 105076	Ref. No.	790300789
	burner head C for burner cap ø 60mm suitable for 70, 90, 92 series (old)		
	No. 105077	Ref. No.	270204230 290200460
	burner ring C for burner cap ø 60mm		
	No. 105091	Ref. No.	770339300
	burner head C for burner cap ø 60mm		

accessories for	105081		
	No. 105081	Ref. No.	290200480 A00004
description	burner cap D ø 80mm		
accessories for	105081		
	No. 104091	Ref. No.	790300799
	burner head D ø 124mm for burner cap ø 80mm suitable for 50, 90, 92, 110 series (old)		
	No. 104093	Ref. No.	270200170 770324790
	venturi C/D		
	No. 104096	Ref. No.	241202412
	burner holder with nozzle holder connection M20x1.5		
	No. 105068	Ref. No.	741312350
	air mixing sleeve		







accessories for 105081	
	No. 105080 Ref. No. 270204240
burner ring D for burner cap ø 80mm	
	No. 105098 Ref. No. 770336750
burner head D for burner cap ø 80mm	







1	
	
No. 105060 Ref. No. 760305080 764305190	
description burner head C for burner cap ø 60mm suitable for 60, 62 series	
accessories for 105060	
	No. 103060 Ref. No. 770319550
burner cap C ø 70mm	
	No. 104096 Ref. No. 241202412
burner holder with nozzle holder connection M20x1.5	
	No. 105062 Ref. No. 760311640
venturi C	
	No. 105068 Ref. No. 741312350
air mixing sleeve	

1	
	
No. 105076 Ref. No. 790300789	
description burner head C for burner cap ø 60mm suitable for 70, 90, 92 series (old)	
accessories for 105076	
	No. 104093 Ref. No. 270200170 770324790
venturi C/D	
	No. 104096 Ref. No. 241202412
burner holder with nozzle holder connection M20x1.5	
	No. 105068 Ref. No. 741312350
air mixing sleeve	
	No. 105077 Ref. No. 270204230 290200460
burner ring C for burner cap ø 60mm	
	No. 105078 Ref. No. 290200450
burner cap C ø 60mm	

1	
	
No. 104091 Ref. No. 790300799	
description burner head D ø 124mm for burner cap ø 80mm suitable for 50, 90, 92, 110 series (old)	
accessories for 104091	
	No. 104093 Ref. No. 270200170 770324790
venturi C/D	
	No. 105068 Ref. No. 741312350
air mixing sleeve	
	No. 105080 Ref. No. 270204240
burner ring D for burner cap ø 80mm	
	No. 105081 Ref. No. 290200480 A00004
burner cap D ø 80mm	





1	
	
No. 104096 Ref. No. 241202412	
description burner holder with nozzle holder connection M20x1.5	
accessories for 104096	
	No. 101250 Ref. No. —
union nut thread M20x1.5 for pipe ø 10mm	
	No. 101278 Ref. No. —
olive for pipe ø 10mm Qty 1 pcs	
	No. 104091 Ref. No. 790300799
burner head D ø 124mm for burner cap ø 80mm suitable for 50, 90, 92, 110 series (old)	
	No. 104093 Ref. No. 270200170 770324790
venturi C/D	
	No. 105060 Ref. No. 760305080 764305190
burner head C for burner cap ø 60mm suitable for 60, 62 series	
	No. 105062 Ref. No. 760311640
venturi C	
	No. 105068 Ref. No. 741312350
air mixing sleeve	
	No. 105076 Ref. No. 790300789
burner head C for burner cap ø 60mm suitable for 70, 90, 92 series (old)	
	No. 105079 Ref. No. 770336760
burner head D ø 100mm	
	No. 105091 Ref. No. 770339300
burner head C for burner cap ø 60mm	

accessories for 104096				
	No.	105098	Ref. No.	770336750
burner head D for burner cap ø 80mm				
	No.	105099	Ref. No.	A00419
burner head A for burner cap ø 110mm				
	No.	105100	Ref. No.	A00418
burner head A for burner cap ø 110mm				
	No.	105119	Ref. No.	A00420
burner head B for burner cap ø 90mm				

				
1				
No.	105077	Ref. No.	270204230 290200460	
description	burner ring C for burner cap ø 60mm			
accessories for 105077				
	No.	104093	Ref. No.	270200170 770324790
venturi C/D				
	No.	104096	Ref. No.	241202412
burner holder with nozzle holder connection M20x1.5				
	No.	105068	Ref. No.	741312350
air mixing sleeve				
	No.	105076	Ref. No.	790300789
burner head C for burner cap ø 60mm suitable for 70, 90, 92 series (old)				
	No.	105078	Ref. No.	290200450
burner cap C ø 60mm				
	No.	105091	Ref. No.	770339300
burner head C for burner cap ø 60mm				

				
1				
No.	105080	Ref. No.	270204240	
description	burner ring D for burner cap ø 80mm			
accessories for 105080				
	No.	104091	Ref. No.	790300799
burner head D ø 124mm for burner cap ø 80mm suitable for 50, 90, 92, 110 series (old)				
	No.	104093	Ref. No.	270200170 770324790
venturi C/D				
	No.	104096	Ref. No.	241202412
burner holder with nozzle holder connection M20x1.5				
	No.	105068	Ref. No.	741312350
air mixing sleeve				
	No.	105081	Ref. No.	290200480 A00004
burner cap D ø 80mm				



accessories for 105080				
	No.	105098	Ref. No.	770336750
burner head D for burner cap ø 80mm				

				
1				
No.	105062	Ref. No.	760311640	
description	venturi C			
accessories for 105062				
	No.	103060	Ref. No.	770319550
burner cap C ø 70mm				
	No.	104096	Ref. No.	241202412
burner holder with nozzle holder connection M20x1.5				
	No.	105060	Ref. No.	760305080 764305190
burner head C for burner cap ø 60mm suitable for 60, 62 series				
	No.	105068	Ref. No.	741312350
air mixing sleeve				

				
1				
No.	104093	Ref. No.	270200170 770324790	
description	venturi C/D			
accessories for 104093				
	No.	104091	Ref. No.	790300799
burner head D ø 124mm for burner cap ø 80mm suitable for 50, 90, 92, 110 series (old)				
	No.	104096	Ref. No.	241202412
burner holder with nozzle holder connection M20x1.5				
	No.	105068	Ref. No.	741312350
air mixing sleeve				
	No.	105076	Ref. No.	790300789
burner head C for burner cap ø 60mm suitable for 70, 90, 92 series (old)				
	No.	105079	Ref. No.	770336760
burner head D ø 100mm				
	No.	105091	Ref. No.	770339300
burner head C for burner cap ø 60mm				
	No.	105098	Ref. No.	770336750
burner head D for burner cap ø 80mm				
	No.	105099	Ref. No.	A00419
burner head A for burner cap ø 110mm				

Table continues overleaf





accessories for	104093			
	No.	105100	Ref. No.	A00418
	burner head A for burner cap ø 110mm			
	No.	105119	Ref. No.	A00420
	burner head B for burner cap ø 90mm			



500, 700new, 900, 920, 110 (new series)





	1			
No.	105068	Ref. No.	741312350	
description	air mixing sleeve			
accessories for	105068			
	No.	104091	Ref. No.	790300799
	burner head D ø 124mm for burner cap ø 80mm suitable for 50, 90, 92, 110 series (old)			
	No.	104093	Ref. No.	270200170 770324790
	venturi C/D			
	No.	104096	Ref. No.	241202412
	burner holder with nozzle holder connection M20x1.5			
	No.	105060	Ref. No.	760305080 764305190
	burner head C for burner cap ø 60mm suitable for 60, 62 series			
	No.	105062	Ref. No.	760311640
	venturi C			
	No.	105076	Ref. No.	790300789
	burner head C for burner cap ø 60mm suitable for 70, 90, 92 series (old)			
	No.	105079	Ref. No.	770336760
	burner head D ø 100mm			
	No.	105091	Ref. No.	770339300
	burner head C for burner cap ø 60mm			
	No.	105098	Ref. No.	770336750
	burner head D for burner cap ø 80mm			
	No.	105099	Ref. No.	A00419
	burner head A for burner cap ø 110mm			
	No.	105100	Ref. No.	A00418
	burner head A for burner cap ø 110mm			
	No.	105119	Ref. No.	A00420
	burner head B for burner cap ø 90mm			
	No.	105707	Ref. No.	—
	burner cap ø 95mm			
	No.	105708	Ref. No.	—
	burner head for burner cap ø 95mm			
	No.	105709	Ref. No.	—
	venturi			

accessories for	105068			
	No.	105710	Ref. No.	—
	burner holder with nozzle holder			

	1			
No.	105088	Ref. No.	270203540	
description	burner cap A ø 110mm with central hole			
accessories for	105088			
	No.	104093	Ref. No.	270200170 770324790
	venturi C/D			
	No.	104096	Ref. No.	241202412
	burner holder with nozzle holder connection M20x1.5			
	No.	105068	Ref. No.	741312350
	air mixing sleeve			
	No.	105099	Ref. No.	A00419
	burner head A for burner cap ø 110mm			
	No.	105100	Ref. No.	A00418
	burner head A for burner cap ø 110mm			

	1			
No.	105084	Ref. No.	270203550	
description	burner cap B ø 90mm with central hole			
accessories for	105084			
	No.	104093	Ref. No.	270200170 770324790
	venturi C/D			
	No.	104096	Ref. No.	241202412
	burner holder with nozzle holder connection M20x1.5			
	No.	105068	Ref. No.	741312350
	air mixing sleeve			
	No.	105119	Ref. No.	A00420
	burner head B for burner cap ø 90mm			

	1			
No.	105078	Ref. No.	290200450	
description	burner cap C ø 60mm			
accessories for	105078			
	No.	104093	Ref. No.	270200170 770324790
	venturi C/D			
	No.	104096	Ref. No.	241202412
	burner holder with nozzle holder connection M20x1.5			

accessories for 105078				
	No.	105068	Ref. No.	741312350
air mixing sleeve				
	No.	105076	Ref. No.	790300789
burner head C for burner cap ø 60mm suitable for 70, 90, 92 series (old)				
	No.	105077	Ref. No.	270204230 290200460
burner ring C for burner cap ø 60mm				
	No.	105091	Ref. No.	770339300
burner head C for burner cap ø 60mm				

				
1				
No.	105081	Ref. No.	290200480 A00004	
description	burner cap D ø 80mm			
accessories for 105081				
	No.	104091	Ref. No.	790300799
burner head D ø 124mm for burner cap ø 80mm suitable for 50, 90, 92, 110 series (old)				
	No.	104093	Ref. No.	270200170 770324790
venturi C/D				
	No.	104096	Ref. No.	241202412
burner holder with nozzle holder connection M20x1.5				
	No.	105068	Ref. No.	741312350
air mixing sleeve				
	No.	105080	Ref. No.	270204240
burner ring D for burner cap ø 80mm				
	No.	105098	Ref. No.	770336750
burner head D for burner cap ø 80mm				

				
1				
No.	105099	Ref. No.	A00419	
description	burner head A for burner cap ø 110mm			
accessories for 105099				
	No.	104093	Ref. No.	270200170 770324790
venturi C/D				
	No.	104096	Ref. No.	241202412
burner holder with nozzle holder connection M20x1.5				
	No.	105068	Ref. No.	741312350
air mixing sleeve				
	No.	105088	Ref. No.	270203540
burner cap A ø 110mm with central hole				

				
1				
No.	105100	Ref. No.	A00418	
description	burner head A for burner cap ø 110mm			
accessories for 105100				
	No.	104093	Ref. No.	270200170 770324790
venturi C/D				
	No.	104096	Ref. No.	241202412
burner holder with nozzle holder connection M20x1.5				
	No.	105068	Ref. No.	741312350
air mixing sleeve				
	No.	105088	Ref. No.	270203540
burner cap A ø 110mm with central hole				

				
1				
No.	105119	Ref. No.	A00420	
description	burner head B for burner cap ø 90mm			
accessories for 105119				
	No.	104093	Ref. No.	270200170 770324790
venturi C/D				
	No.	104096	Ref. No.	241202412
burner holder with nozzle holder connection M20x1.5				
	No.	105068	Ref. No.	741312350
air mixing sleeve				
	No.	105084	Ref. No.	270203550
burner cap B ø 90mm with central hole				













				
1				
No.	105091	Ref. No.	770339300	
description	burner head C for burner cap ø 60mm			
accessories for 105091				
	No.	104093	Ref. No.	270200170 770324790
venturi C/D				
	No.	104096	Ref. No.	241202412
burner holder with nozzle holder connection M20x1.5				

Table continues overleaf









accessories for 105091				
	No.	105068	Ref. No.	741312350
air mixing sleeve				
	No.	105077	Ref. No.	270204230 290200460
burner ring C for burner cap ø 60mm				
	No.	105078	Ref. No.	290200450
burner cap C ø 60mm				











				
1				
No.	105098	Ref. No.	770336750	
description burner head D for burner cap ø 80mm				
accessories for 105098				
	No.	104093	Ref. No.	270200170 770324790
venturi C/D				
	No.	104096	Ref. No.	241202412
burner holder with nozzle holder connection M20x1.5				
	No.	105068	Ref. No.	741312350
air mixing sleeve				
	No.	105080	Ref. No.	270204240
burner ring D for burner cap ø 80mm				
	No.	105081	Ref. No.	290200480 A00004
burner cap D ø 80mm				

				
1				
No.	104096	Ref. No.	241202412	
description burner holder with nozzle holder connection M20x1.5				
accessories for 104096				
	No.	101250	Ref. No.	—
union nut thread M20x1.5 for pipe ø 10mm				
	No.	101278	Ref. No.	—
olive for pipe ø 10mm Qty 1 pcs				
	No.	104091	Ref. No.	790300799
burner head D ø 124mm for burner cap ø 80mm suitable for 50, 90, 92, 110 series (old)				
	No.	104093	Ref. No.	270200170 770324790
venturi C/D				
	No.	105060	Ref. No.	760305080 764305190
burner head C for burner cap ø 60mm suitable for 60, 62 series				

accessories for 104096				
	No.	105062	Ref. No.	760311640
venturi C				
	No.	105068	Ref. No.	741312350
air mixing sleeve				
	No.	105076	Ref. No.	790300789
burner head C for burner cap ø 60mm suitable for 70, 90, 92 series (old)				
	No.	105079	Ref. No.	770336760
burner head D ø 100mm				
	No.	105091	Ref. No.	770339300
burner head C for burner cap ø 60mm				
	No.	105098	Ref. No.	770336750
burner head D for burner cap ø 80mm				
	No.	105099	Ref. No.	A00419
burner head A for burner cap ø 110mm				
	No.	105100	Ref. No.	A00418
burner head A for burner cap ø 110mm				
	No.	105119	Ref. No.	A00420
burner head B for burner cap ø 90mm				

				
1				
No.	105077	Ref. No.	270204230 290200460	
description burner ring C for burner cap ø 60mm				
accessories for 105077				
	No.	104093	Ref. No.	270200170 770324790
venturi C/D				
	No.	104096	Ref. No.	241202412
burner holder with nozzle holder connection M20x1.5				
	No.	105068	Ref. No.	741312350
air mixing sleeve				
	No.	105076	Ref. No.	790300789
burner head C for burner cap ø 60mm suitable for 70, 90, 92 series (old)				
	No.	105078	Ref. No.	290200450
burner cap C ø 60mm				
	No.	105091	Ref. No.	770339300
burner head C for burner cap ø 60mm				

			
No.	105080	Ref. No.	270204240
description	burner ring D for burner cap ø 80mm		
accessories for	105080		
	No.	104091	Ref. No. 790300799
burner head D ø 124mm for burner cap ø 80mm suitable for 50, 90, 92, 110 series (old)			
	No.	104093	Ref. No. 270200170 770324790
venturi C/D			
	No.	104096	Ref. No. 241202412
burner holder with nozzle holder connection M20x1.5			
	No.	105068	Ref. No. 741312350
air mixing sleeve			
	No.	105081	Ref. No. 290200480 A00004
burner cap D ø 80mm			
	No.	105098	Ref. No. 770336750
burner head D for burner cap ø 80mm			

			
No.	104093	Ref. No.	270200170 770324790
description	venturi C/D		
accessories for	104093		
	No.	104091	Ref. No. 790300799
burner head D ø 124mm for burner cap ø 80mm suitable for 50, 90, 92, 110 series (old)			
	No.	104096	Ref. No. 241202412
burner holder with nozzle holder connection M20x1.5			
	No.	105068	Ref. No. 741312350
air mixing sleeve			
	No.	105076	Ref. No. 790300789
burner head C for burner cap ø 60mm suitable for 70, 90, 92 series (old)			
	No.	105079	Ref. No. 770336760
burner head D ø 100mm			
	No.	105091	Ref. No. 770339300
burner head C for burner cap ø 60mm			
	No.	105098	Ref. No. 770336750
burner head D for burner cap ø 80mm			
	No.	105099	Ref. No. A00419
burner head A for burner cap ø 110mm			
	No.	105100	Ref. No. A00418
burner head A for burner cap ø 110mm			

accessories for	104093		
	No.	105119	Ref. No. A00420
burner head B for burner cap ø 90mm			























700/900 (old series)			
			
No.	105068	Ref. No.	741312350
description	air mixing sleeve		
accessories for	105068		
	No.	104091	Ref. No. 790300799
burner head D ø 124mm for burner cap ø 80mm suitable for 50, 90, 92, 110 series (old)			
	No.	104093	Ref. No. 270200170 770324790
venturi C/D			
	No.	104096	Ref. No. 241202412
burner holder with nozzle holder connection M20x1.5			
	No.	105060	Ref. No. 760305080 764305190
burner head C for burner cap ø 60mm suitable for 60, 62 series			
	No.	105062	Ref. No. 760311640
venturi C			
	No.	105076	Ref. No. 790300789
burner head C for burner cap ø 60mm suitable for 70, 90, 92 series (old)			
	No.	105079	Ref. No. 770336760
burner head D ø 100mm			
	No.	105091	Ref. No. 770339300
burner head C for burner cap ø 60mm			
	No.	105098	Ref. No. 770336750
burner head D for burner cap ø 80mm			
	No.	105099	Ref. No. A00419
burner head A for burner cap ø 110mm			
	No.	105100	Ref. No. A00418
burner head A for burner cap ø 110mm			
	No.	105119	Ref. No. A00420
burner head B for burner cap ø 90mm			
	No.	105707	Ref. No. —
burner cap ø 95mm			
	No.	105708	Ref. No. —
burner head for burner cap ø 95mm			
	No.	105709	Ref. No. —
venturi			

Table continues overleaf



accessories for	105068		
	No.	105710	Ref. No.
			—
	burner holder with nozzle holder		





1			
	No.	103060	Ref. No.
			770319550
description	burner cap C ø 70mm		
accessories for	103060		
	No.	104096	Ref. No.
			241202412
	burner holder with nozzle holder connection M20x1.5		
	No.	105060	Ref. No.
			760305080 764305190
	burner head C for burner cap ø 60mm suitable for 60, 62 series		
	No.	105062	Ref. No.
			760311640
	venturi C		
	No.	105068	Ref. No.
			741312350
	air mixing sleeve		

1			
	No.	103061	Ref. No.
			770319560
description	burner cap D ø 100mm		
accessories for	103061		
	No.	104091	Ref. No.
			790300799
	burner head D ø 124mm for burner cap ø 80mm suitable for 50, 90, 92, 110 series (old)		
	No.	104093	Ref. No.
			270200170 770324790
	venturi C/D		
	No.	104096	Ref. No.
			241202412
	burner holder with nozzle holder connection M20x1.5		
	No.	105068	Ref. No.
			741312350
	air mixing sleeve		
	No.	105079	Ref. No.
			770336760
	burner head D ø 100mm		

1			
	No.	103062	Ref. No.
			241200430
description	burner cap E ø 135mm		

1			
	No.	104091	Ref. No.
			790300799
description	burner head D ø 124mm for burner cap ø 80mm suitable for 50, 90, 92, 110 series (old)		
accessories for	104091		
	No.	104093	Ref. No.
			270200170 770324790
	venturi C/D		
	No.	105068	Ref. No.
			741312350
	air mixing sleeve		
	No.	105080	Ref. No.
			270204240
	burner ring D for burner cap ø 80mm		
	No.	105081	Ref. No.
			290200480 A00004
	burner cap D ø 80mm		

1			
	No.	104096	Ref. No.
			241202412
description	burner holder with nozzle holder connection M20x1.5		
accessories for	104096		
	No.	101250	Ref. No.
			—
	union nut thread M20x1.5 for pipe ø 10mm		
	No.	101278	Ref. No.
			—
	olive for pipe ø 10mm Qty 1 pcs		
	No.	104091	Ref. No.
			790300799
	burner head D ø 124mm for burner cap ø 80mm suitable for 50, 90, 92, 110 series (old)		
	No.	104093	Ref. No.
			270200170 770324790
	venturi C/D		
	No.	105060	Ref. No.
			760305080 764305190
	burner head C for burner cap ø 60mm suitable for 60, 62 series		
	No.	105062	Ref. No.
			760311640
	venturi C		
	No.	105068	Ref. No.
			741312350
	air mixing sleeve		
	No.	105076	Ref. No.
			790300789
	burner head C for burner cap ø 60mm suitable for 70, 90, 92 series (old)		
	No.	105079	Ref. No.
			770336760
	burner head D ø 100mm		
	No.	105091	Ref. No.
			770339300
	burner head C for burner cap ø 60mm		





accessories for 104096			
	No.	105098	Ref. No. 770336750
burner head D for burner cap ø 80mm			
	No.	105099	Ref. No. A00419
burner head A for burner cap ø 110mm			
	No.	105100	Ref. No. A00418
burner head A for burner cap ø 110mm			
	No.	105119	Ref. No. A00420
burner head B for burner cap ø 90mm			





	1		
No.	104093	Ref. No.	270200170 770324790
description	venturi C/D		
accessories for 104093			
	No.	104091	Ref. No. 790300799
burner head D ø 124mm for burner cap ø 80mm suitable for 50, 90, 92, 110 series (old)			
	No.	104096	Ref. No. 241202412
burner holder with nozzle holder connection M20x1.5			
	No.	105068	Ref. No. 741312350
air mixing sleeve			
	No.	105076	Ref. No. 790300789
burner head C for burner cap ø 60mm suitable for 70, 90, 92 series (old)			
	No.	105079	Ref. No. 770336760
burner head D ø 100mm			
	No.	105091	Ref. No. 770339300
burner head C for burner cap ø 60mm			
	No.	105098	Ref. No. 770336750
burner head D for burner cap ø 80mm			
	No.	105099	Ref. No. A00419
burner head A for burner cap ø 110mm			
	No.	105100	Ref. No. A00418
burner head A for burner cap ø 110mm			
	No.	105119	Ref. No. A00420
burner head B for burner cap ø 90mm			



solid tops series 60, 62			
	1		
No.	105068	Ref. No.	741312350
description	air mixing sleeve		
accessories for 105068			
	No.	104091	Ref. No. 790300799
burner head D ø 124mm for burner cap ø 80mm suitable for 50, 90, 92, 110 series (old)			
	No.	104093	Ref. No. 270200170 770324790
venturi C/D			
	No.	104096	Ref. No. 241202412
burner holder with nozzle holder connection M20x1.5			
	No.	105060	Ref. No. 760305080 764305190
burner head C for burner cap ø 60mm suitable for 60, 62 series			
	No.	105062	Ref. No. 760311640
venturi C			
	No.	105076	Ref. No. 790300789
burner head C for burner cap ø 60mm suitable for 70, 90, 92 series (old)			
	No.	105079	Ref. No. 770336760
burner head D ø 100mm			
	No.	105091	Ref. No. 770339300
burner head C for burner cap ø 60mm			
	No.	105098	Ref. No. 770336750
burner head D for burner cap ø 80mm			
	No.	105099	Ref. No. A00419
burner head A for burner cap ø 110mm			
	No.	105100	Ref. No. A00418
burner head A for burner cap ø 110mm			
	No.	105119	Ref. No. A00420
burner head B for burner cap ø 90mm			
	No.	105707	Ref. No. —
burner cap ø 95mm			
	No.	105708	Ref. No. —
burner head for burner cap ø 95mm			
	No.	105709	Ref. No. —
venturi			
	No.	105710	Ref. No. —
burner holder with nozzle holder			



				
1				
No.	105078	Ref. No.	290200450	
description	burner cap C ø 60mm			
accessories for	105078			
	No.	104093	Ref. No.	270200170 770324790
venturi C/D				
	No.	104096	Ref. No.	241202412
burner holder with nozzle holder connection M20x1.5				
	No.	105068	Ref. No.	741312350
air mixing sleeve				
	No.	105076	Ref. No.	790300789
burner head C for burner cap ø 60mm suitable for 70, 90, 92 series (old)				
	No.	105077	Ref. No.	270204230 290200460
burner ring C for burner cap ø 60mm				
	No.	105091	Ref. No.	770339300
burner head C for burner cap ø 60mm				

				
1				
No.	103060	Ref. No.	770319550	
description	burner cap C ø 70mm			
accessories for	103060			
	No.	104096	Ref. No.	241202412
burner holder with nozzle holder connection M20x1.5				
	No.	105060	Ref. No.	760305080 764305190
burner head C for burner cap ø 60mm suitable for 60, 62 series				
	No.	105062	Ref. No.	760311640
venturi C				
	No.	105068	Ref. No.	741312350
air mixing sleeve				

				
1				
No.	103061	Ref. No.	770319560	
description	burner cap D ø 100mm			
accessories for	103061			
	No.	104091	Ref. No.	790300799
burner head D ø 124mm for burner cap ø 80mm suitable for 50, 90, 92, 110 series (old)				
	No.	104093	Ref. No.	270200170 770324790
venturi C/D				
	No.	104096	Ref. No.	241202412
burner holder with nozzle holder connection M20x1.5				



accessories for	103061			
	No.	105068	Ref. No.	741312350
air mixing sleeve				
	No.	105079	Ref. No.	770336760
burner head D ø 100mm				





				
1				
No.	105060	Ref. No.	760305080 764305190	
description	burner head C for burner cap ø 60mm suitable for 60, 62 series			
accessories for	105060			
	No.	103060	Ref. No.	770319550
burner cap C ø 70mm				
	No.	104096	Ref. No.	241202412
burner holder with nozzle holder connection M20x1.5				
	No.	105062	Ref. No.	760311640
venturi C				
	No.	105068	Ref. No.	741312350
air mixing sleeve				





				
1				
No.	105143	Ref. No.	760305630	
description	burner head C for burner cap ø 70mm			

				
1				
No.	105146	Ref. No.	760302390	
description	burner head D for burner cap ø 100mm			
accessories for	105146			
	No.	103061	Ref. No.	770319560
burner cap D ø 100mm				
	No.	104093	Ref. No.	270200170 770324790
venturi C/D				
	No.	104096	Ref. No.	241202412
burner holder with nozzle holder connection M20x1.5				
	No.	105068	Ref. No.	741312350
air mixing sleeve				

			
1			
No.	104096	Ref. No.	241202412
description	burner holder with nozzle holder connection M20x1.5		
accessories for	104096		
	No.	101250	Ref. No. —
union nut thread M20x1.5 for pipe ø 10mm			
	No.	101278	Ref. No. —
olive for pipe ø 10mm Qty 1 pcs			
	No.	104091	Ref. No. 790300799
burner head D ø 124mm for burner cap ø 80mm suitable for 50, 90, 92, 110 series (old)			
	No.	104093	Ref. No. 270200170 770324790
venturi C/D			
	No.	105060	Ref. No. 760305080 764305190
burner head C for burner cap ø 60mm suitable for 60, 62 series			
	No.	105062	Ref. No. 760311640
venturi C			
	No.	105068	Ref. No. 741312350
air mixing sleeve			
	No.	105076	Ref. No. 790300789
burner head C for burner cap ø 60mm suitable for 70, 90, 92 series (old)			
	No.	105079	Ref. No. 770336760
burner head D ø 100mm			
	No.	105091	Ref. No. 770339300
burner head C for burner cap ø 60mm			
	No.	105098	Ref. No. 770336750
burner head D for burner cap ø 80mm			
	No.	105099	Ref. No. A00419
burner head A for burner cap ø 110mm			
	No.	105100	Ref. No. A00418
burner head A for burner cap ø 110mm			
	No.	105119	Ref. No. A00420
burner head B for burner cap ø 90mm			

			
1			
No.	105077	Ref. No.	270204230 290200460
description	burner ring C for burner cap ø 60mm		
accessories for	105077		
	No.	104093	Ref. No. 270200170 770324790
venturi C/D			

accessories for	105077		
	No.	104096	Ref. No. 241202412
burner holder with nozzle holder connection M20x1.5			
	No.	105068	Ref. No. 741312350
air mixing sleeve			
	No.	105076	Ref. No. 790300789
burner head C for burner cap ø 60mm suitable for 70, 90, 92 series (old)			
	No.	105078	Ref. No. 290200450
burner cap C ø 60mm			
	No.	105091	Ref. No. 770339300
burner head C for burner cap ø 60mm			

			
1			
No.	105062	Ref. No.	760311640
description	venturi C		
accessories for	105062		
	No.	103060	Ref. No. 770319550
burner cap C ø 70mm			
	No.	104096	Ref. No. 241202412
burner holder with nozzle holder connection M20x1.5			
	No.	105060	Ref. No. 760305080 764305190
burner head C for burner cap ø 60mm suitable for 60, 62 series			
	No.	105068	Ref. No. 741312350
air mixing sleeve			

solid tops series 70, 90, 92, 110 (old), 700, 900, 920, 110 (new)

















			
1			
No.	105068	Ref. No.	741312350
description	air mixing sleeve		
accessories for	105068		
	No.	104091	Ref. No. 790300799
burner head D ø 124mm for burner cap ø 80mm suitable for 50, 90, 92, 110 series (old)			
	No.	104093	Ref. No. 270200170 770324790
venturi C/D			
	No.	104096	Ref. No. 241202412
burner holder with nozzle holder connection M20x1.5			
	No.	105060	Ref. No. 760305080 764305190
burner head C for burner cap ø 60mm suitable for 60, 62 series			

Table continues overleaf



accessories for 105068	
	No. 105062 Ref. No. 760311640
venturi C	
	No. 105076 Ref. No. 790300789
burner head C for burner cap ø 60mm suitable for 70, 90, 92 series (old)	
	No. 105079 Ref. No. 770336760
burner head D ø 100mm	
	No. 105091 Ref. No. 770339300
burner head C for burner cap ø 60mm	
	No. 105098 Ref. No. 770336750
burner head D for burner cap ø 80mm	
	No. 105099 Ref. No. A00419
burner head A for burner cap ø 110mm	
	No. 105100 Ref. No. A00418
burner head A for burner cap ø 110mm	
	No. 105119 Ref. No. A00420
burner head B for burner cap ø 90mm	
	No. 105707 Ref. No. —
burner cap ø 95mm	
	No. 105708 Ref. No. —
burner head for burner cap ø 95mm	
	No. 105709 Ref. No. —
venturi	
	No. 105710 Ref. No. —
burner holder with nozzle holder	

	
1	
No. 105078	Ref. No. 290200450
description burner cap C ø 60mm	
accessories for 105078	
	No. 104093 Ref. No. 270200170 770324790
venturi C/D	
	No. 104096 Ref. No. 241202412
burner holder with nozzle holder connection M20x1.5	
	No. 105068 Ref. No. 741312350
air mixing sleeve	
	No. 105076 Ref. No. 790300789
burner head C for burner cap ø 60mm suitable for 70, 90, 92 series (old)	
	No. 105077 Ref. No. 270204230 290200460
burner ring C for burner cap ø 60mm	
	No. 105091 Ref. No. 770339300
burner head C for burner cap ø 60mm	

	
1	
No. 103061	Ref. No. 770319560
description burner cap D ø 100mm	
accessories for 103061	
	No. 104091 Ref. No. 790300799
burner head D ø 124mm for burner cap ø 80mm suitable for 50, 90, 92, 110 series (old)	
	No. 104093 Ref. No. 270200170 770324790
venturi C/D	
	No. 104096 Ref. No. 241202412
burner holder with nozzle holder connection M20x1.5	
	No. 105068 Ref. No. 741312350
air mixing sleeve	
	No. 105079 Ref. No. 770336760
burner head D ø 100mm	

	
1	
No. 105076	Ref. No. 790300789
description burner head C for burner cap ø 60mm suitable for 70, 90, 92 series (old)	
accessories for 105076	
	No. 104093 Ref. No. 270200170 770324790
venturi C/D	
	No. 104096 Ref. No. 241202412
burner holder with nozzle holder connection M20x1.5	
	No. 105068 Ref. No. 741312350
air mixing sleeve	
	No. 105077 Ref. No. 270204230 290200460
burner ring C for burner cap ø 60mm	
	No. 105078 Ref. No. 290200450
burner cap C ø 60mm	

















	
1	
No. 105079	Ref. No. 770336760
description burner head D ø 100mm	
accessories for 105079	
	No. 103061 Ref. No. 770319560
burner cap D ø 100mm	

Table continues overleaf

accessories for 105079				
	No.	104093	Ref. No.	270200170 770324790
venturi C/D				
	No.	104096	Ref. No.	241202412
burner holder with nozzle holder connection M20x1.5				
	No.	105068	Ref. No.	741312350
air mixing sleeve				

				
1				
No.	105144	Ref. No.	290202870	
description	burner head for burner cap ø 100mm			

				
1				
No.	104096	Ref. No.	241202412	
description	burner holder with nozzle holder connection M20x1.5			
accessories for 104096				
	No.	101250	Ref. No.	—
union nut thread M20x1.5 for pipe ø 10mm				
	No.	101278	Ref. No.	—
olive for pipe ø 10mm Qty 1 pcs				
	No.	104091	Ref. No.	790300799
burner head D ø 124mm for burner cap ø 80mm suitable for 50, 90, 92, 110 series (old)				
	No.	104093	Ref. No.	270200170 770324790
venturi C/D				
	No.	105060	Ref. No.	760305080 764305190
burner head C for burner cap ø 60mm suitable for 60, 62 series				
	No.	105062	Ref. No.	760311640
venturi C				
	No.	105068	Ref. No.	741312350
air mixing sleeve				
	No.	105076	Ref. No.	790300789
burner head C for burner cap ø 60mm suitable for 70, 90, 92 series (old)				
	No.	105079	Ref. No.	770336760
burner head D ø 100mm				
	No.	105091	Ref. No.	770339300
burner head C for burner cap ø 60mm				
	No.	105098	Ref. No.	770336750
burner head D for burner cap ø 80mm				

accessories for 104096				
	No.	105099	Ref. No.	A00419
burner head A for burner cap ø 110mm				
	No.	105100	Ref. No.	A00418
burner head A for burner cap ø 110mm				
	No.	105119	Ref. No.	A00420
burner head B for burner cap ø 90mm				

				
1				
No.	105077	Ref. No.	270204230 290200460	
description	burner ring C for burner cap ø 60mm			
accessories for 105077				
	No.	104093	Ref. No.	270200170 770324790
venturi C/D				
	No.	104096	Ref. No.	241202412
burner holder with nozzle holder connection M20x1.5				
	No.	105068	Ref. No.	741312350
air mixing sleeve				
	No.	105076	Ref. No.	790300789
burner head C for burner cap ø 60mm suitable for 70, 90, 92 series (old)				
	No.	105078	Ref. No.	290200450
burner cap C ø 60mm				
	No.	105091	Ref. No.	770339300
burner head C for burner cap ø 60mm				

				
1				
No.	105147	Ref. No.	A00024	
description	nozzle holder L 61mm M10x1 gas inlet 1/2" gas outlet M14x1			

				
1				
No.	105364	Ref. No.	A00176	
description	round burner ø 190mm			



			
No.	104093	Ref. No.	270200170 770324790
description	venturi C/D		
accessories for	104093		
			
No.	104091	Ref. No.	790300799
description	burner head D ø 124mm for burner cap ø 80mm suitable for 50, 90, 92, 110 series (old)		
			
No.	104096	Ref. No.	241202412
description	burner holder with nozzle holder connection M20x1.5		
			
No.	105068	Ref. No.	741312350
description	air mixing sleeve		
			
No.	105076	Ref. No.	790300789
description	burner head C for burner cap ø 60mm suitable for 70, 90, 92 series (old)		
			
No.	105079	Ref. No.	770336760
description	burner head D ø 100mm		
			
No.	105091	Ref. No.	770339300
description	burner head C for burner cap ø 60mm		
			
No.	105098	Ref. No.	770336750
description	burner head D for burner cap ø 80mm		
			
No.	105099	Ref. No.	A00419
description	burner head A for burner cap ø 110mm		
			
No.	105100	Ref. No.	A00418
description	burner head A for burner cap ø 110mm		
			
No.	105119	Ref. No.	A00420
description	burner head B for burner cap ø 90mm		

accessories

nozzle holders



No.	105147	Ref. No.	A00024
description	nozzle holder L 61mm M10x1 gas inlet 1/2" gas outlet M14x1		

gaskets

gaskets for heated units

door seals

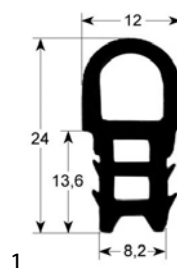

No.	900171	Ref. No.	284204130
description	door seal profile 2050 external size Qty supplied by meter		