

Professionall

Solutii profesionale pentru echipamente profesionale



GAS COMPONENTS



ELECTRIC COMPONENTS



WATER TECHNOLOGY



MECHANICAL COMPONENTS



TOOLS

Spare parts suitable for

DEAN



heating elements

heating elements for fryers

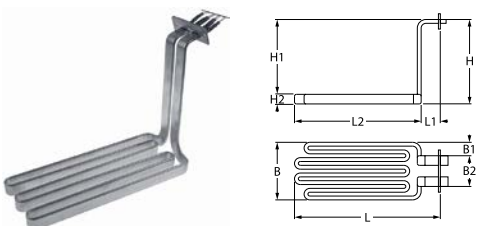

No.	417623	Ref. No.	8262155
description	heating element 8500W 240V L 400mm W 145mm H 300mm flange connection plug heating circuits 3 fryer heaters L1 352mm L2 30mm H1 255mm H2 25mm hole distance 85mm hole ø 6mm flange length 101mm flange width 35mm cable length 1000mm		

thermostats

control and safety thermostats

INVENSYS / ROBERTSHAW

control thermostats



No.	390636	Ref. No.	1175 1204 2557 807-3515
description	thermostat t.max. 204°C temperature range 93-204°C 1-pole 1NO 0.67A probe ø 9.5mm probe L 123mm capillary pipe 915mm capillary pipe isolatedmm gland nut 1/4" NPT shaft ø 6x4.6mm shaft L 21mm shaft position lower rotation 315° probe material nickel-plated probe thread 1/4" US		





gas valves and ignition boxes

gas control valves

ROBERTSHAW

millivolt controlled valves



No.	580031	Ref. No.	1896
description	gas valve supply Operator millivolt gas inlet 3/4" NPT gas outlet 3/4" NPT thermocouple connection pilot connection 1/4" CCT type 7000BMVR pressure controller natural gas 3.5" W.C. suitable for ROBERTSHAW		
spare parts for	580031		
	No.	101422	Ref. No. —
operator natural gas supply Operator millivolt			
	No.	106109	Ref. No. —
locking screw thread 7/16"-24 UNS for pipe ø 1/4" L 16mm brass Qty 1 pcs WS 7/16" (11.113mm) hole ø 6.4mm			
	No.	106121	Ref. No. —
pressure controller natural gas 3.5" W.C.			
	No.	580033	Ref. No. —
knob suitable for ROBERTSHAW			

ignition parts

thermocouples

thermocouple sets universal



No.	102281	Ref. No.	1149
description	thermocouple set ROBERTSHAW 5-piece L 24" - 610mm		



thermopiles

No.	580035	Ref. No.	1897
description	thermopile L 36" - 915mm probe \varnothing 9mm probe L 38mm 250-750mV screw connection 7/16" connection 3/8" NEF		

No.	103243	Ref. No.	807-3485 810-2033
description	thermopile with PG9 adapter WHITE RODGERS L 36" - 915mm probe \varnothing 9mm probe L 40mm 250-750mV screw connection 7/16" connection spate terminals		

No.	970183	Ref. No.	1362 2608 803-0307 S2139
description	fryer basket L1 308mm W1 160mm H1 135mm		

No.	970184	Ref. No.	1727
description	fryer basket L1 330mm W1 315mm H1 135mm		

baskets

fryer baskets

US producers

No.	970134	Ref. No.	1953
description	fryer basket L1 280mm W1 140mm H1 105mm		