

Professionall

Solutii profesionale pentru echipamente profesionale



GAS COMPONENTS



ELECTRIC COMPONENTS



WATER TECHNOLOGY



MECHANICAL COMPONENTS



TOOLS

Spare parts suitable for

CHARVET



heating elements

heating elements for ovens

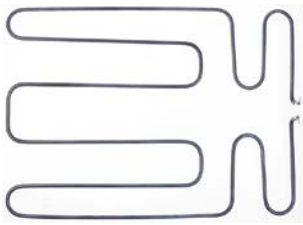

No.	420237	Ref. No.	02062A
description	heating element 2500W 230V L 600mm W 435mm H 29mm lug length 18mm lug width 7mm hole distance 50mm tube ø 8.5mm connection M4 heating circuits 1 dry heating element bracket mounting for oven		

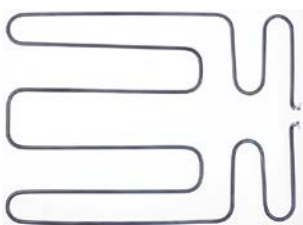

No.	420236	Ref. No.	02063A
description	heating element 2500W 400V L 600mm W 435mm H 29mm lug length 18mm lug width 7mm hole distance 50mm tube ø 8.5mm connection M4 heating circuits 1 dry heating element bracket mounting for oven		

heating elements for bain maries



No.	420002	Ref. No.	03746A
description	heating element 2000W 230V heating circuits 1 L 383mm L1 20mm W 235mm connection M4 connection distance 225mm tube ø 8.5mm dry heating element bain marie L2 363mm H 15mm		

heating elements for griddles



No.	420001	Ref. No.	03483A
description	heating element 1000W 230V heating circuits 1 L 405mm W 60mm Hmm tube ø 10mm 2 hole fixing connection M4 thread M14x1.25 mounting distance 45mm connection length 30mm dry heating element		

heating elements for tilting bratt pan









No.	420555	Ref. No.	04448A
description	heating element 3000W 230V L 570mm W 90mm H 25mm connection screw connection heating circuits 1 tube ø 8mm		

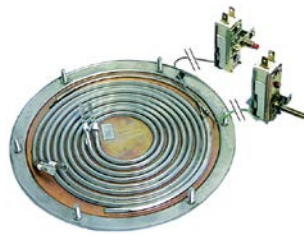

No.	420233	Ref. No.	07668A
description	heating element 3300W 230V L 565mm W 84mm H 118mm connection M4 dry heating element heating circuits 1 tube ø 8.5mm		

bottom heaters



No.	415661	Ref. No.	07369A	
description	bottom heater 3000W 230V heating circuits 2 ø 196mm safety thermostat 250°C thermostat 128°C M5 mounting distance 180mm			
spare parts for	415661			
	No.	102067	Ref. No.	—
	nut thread M8x1 H 3mm brass Qty 1 pcs type SEF 1			
	No.	375137	Ref. No.	—
	safety thermostat switch-off temp. 250°C 1-pole 16A probe ø 3.03mm probe L 160mm capillary pipe 880mm capillary pipe isolated 800mm gland nut probe SS with curved probe			
	No.	375300	Ref. No.	—
	thermostat t.max. 128°C temperature range 35-128°C 1-pole 1NO 16A probe ø 3.1mm probe L 174mm capillary pipe 880mm capillary pipe isolated 800mm gland nut shaft L 23mm shaft position lower rotation 270°			
accessories for	415661			
	No.	520323	Ref. No.	—
	gasket ID ø 160mm ED ø 200mm hole distance 90/180mm hole ø 7mm silicone for bottom heaters			
	No.	520324	Ref. No.	—
	counterflange ID ø 160mm ED ø 200mm hole distance 90/180mm hole ø 7mm SS for bottom heaters			
	No.	551083	Ref. No.	—
	cap for safety thermostat thread M8x1			

heating rods





No.	418459	Ref. No.	02030A
description	heating element 1000W 240V connection M5 L 630mm W 38mm H 8mm hole distance 650mm hole ø 8mm		



			
1			
No.	420554	Ref. No.	504998
description	heating element 1250W 240V L 680mm W 40mm H 10mm cable length 470mm		

immersion heating elements

			
1			
No.	420231	Ref. No.	03345A
description	heating element 3000W 230V heating circuits 1 L 665mm W 90mm tube ø 8.5mm connection M6 2 hole fixing for kettle thread M14x1.5		

			
1			
No.	420232	Ref. No.	03346A
description	heating element 3500W 230V heating circuits 1 L 665mm W 110mm Hmm tube ø 8mm connection M6 2 hole fixing thread M14x1.5		

hot plates

square & rectangular

with cast edge

with screw connection

			
1			
No.	490078	Ref. No.	06048A
description	hot plate dimensions 300x300mm 3000W 400V with cast edge connection 4 screw clamps square		

tiltable

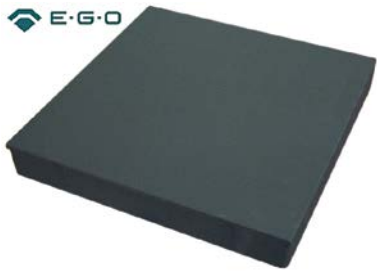
			
1			
No.	490090	Ref. No.	2078A
description	hot plate dimensions 300x300mm 4000W 400V with cast edge tilt boiling plate connection 4 screw clamps H 43mm square		

energy regulators

EGO

1-circuit

			
1			
No.	380015	Ref. No.	09099A
description	energy regulator 230V 13A single-circuit turn direction right shaft ø 6x4.6mm shaft L 23mm mounting thread M4 power release 6-100% no. 50.57021.010		



			
1			
No.	380013	Ref. No.	09088A
description	energy regulator 400V 7A single-circuit turn direction right shaft ø 6x4.6mm mounting thread M4 no. 50.57031.010		

DIAMOND

			
1			
No.	380037	Ref. No.	02004A
description	energy regulator 240V 13.5A turn direction right shaft ø 6x4.6mm shaft L 13mm mounting thread 3/8"-24UNF equiv. no. 35ERE101230V		

			
1			
No.	380038	Ref. No.	2003A
description	energy regulator 24V 13.5A turn direction right shaft ø 6x4.6mm mounting thread 3/8"-24UNF equiv. no. 35ERE105024V voltage AC		



			
1			
No.	380039	Ref. No.	02005A 02006A
description	energy regulator 400V 13.5A turn direction right shaft ø 6x4.6mm mounting thread 3/8"-24UNF equiv. no. 35ERE104400V		
accessories for	380039		
	No.	361181	Ref. No. —
	nut thread 1/8" H 4.5mm nickel-plated brass WS 14 Qty 1 pcs		

thermostats

control and safety thermostats

EGO

control thermostats

55.34_series

			
1			
No.	375143	Ref. No.	1995A
description	thermostat t.max. 110°C temperature range 32-110°C 3-pole 3NO 16A probe ø 6mm probe L 138mm capillary pipe 1480mm capillary pipe isolated 1100mm gland nut M9x1 shaft ø 6x4.6mm shaft L 23mm shaft position upper rotation 270°		

			
1			
No.	375020	Ref. No.	1995A
description	thermostat t.max. 110°C temperature range 32-110°C 3-pole capillary pipe isolatedmm gland nut		

			
1			
No.	375038	Ref. No.	01990A
description	thermostat t.max. 300°C temperature range 50-300°C 3-pole 3NO 16A probe ø 6mm probe L 79mm capillary pipe 1740mm capillary pipe isolated 800mm gland nut shaft ø 6x4.6mm shaft L 23mm shaft position upper rotation 270°		
accessories for	375038		
	No.	110123	Ref. No. —
	knob thermostat t.max. 300°C ø 50mm shaft ø 6x4.6mm shaft flat upper black temperature range 50-300°C rotation 270°		

			
1			
No.	375026	Ref. No.	01999a
description	thermostat t.max. 350°C temperature range 100-350°C 3-pole 3NO 16A probe ø 6mm probe L 77mm capillary pipe 2430mm capillary pipe isolated 1100mm gland nut shaft ø 6x4.6mm shaft L 23mm shaft position upper rotation 270°		

safety thermostats

55.32_series

			
1			
No.	390813	Ref. No.	40100080
description	safety thermostat switch-off temp. 245°C 3-pole 20A probe ø 6mm probe L 78mm capillary pipe 1500mm capillary pipe isolated 1050mm gland nut M9x1 probe		



55.33_series



1

No.	375796	Ref. No.	02823A
description	safety thermostat switch-off temp. 220°C 3-pole 3NC 20A probe ø 6mm probe L 107mm capillary pipe 870mm capillary pipe isolated 800mm gland nut probe		



1

No.	390675	Ref. No.	05996A
description	safety thermostat switch-off temp. 230°C 3-pole 20A probe ø 6mm probe L 88mm capillary pipe 2200mm capillary pipe isolatedmm gland nut probe		

switches and momentary switches

microswitches

lever actuated



1

No.	345742	Ref. No.	07676A
description	microswitch with lever 250V 16A 1CO connection male faston 6.3mm L 55mm ambient temperature max. 120°C mounting distance 22mm actuating force: 75g lever length 46mm		



1

No.	345363	Ref. No.	07676A
description	microswitch with lever 250V 16A 1CO connection male faston 6.3mm L 56mm ambient temperature max. 125°C		



1

No.	345074	Ref. No.	08233A
description	microswitch with lever 250V 16A 1CO connection male faston 6.3mm ambient temperature max. 85°C mounting distance 25mm type C99ZP3 actuating force: 25g lever length 154mm		

roller-lever actuated

microswitches

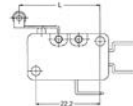

1

No.	345041	Ref. No.	504985
description	microswitch with handle with a switch 250V 16A 1CO connection male faston 6.3mm ambient temperature max. 85°C black lever length 20.5mm		

heavy duty version



1

No.	347718	Ref. No.	07675A
description	microswitch with handle with a switch 250V 16A 1CO connection screw L 36mm L1 39mm ambient temperature max. 85°C mounting distance 26mm type MS-42 actuating force: 50g lever length 51mm		

float switches

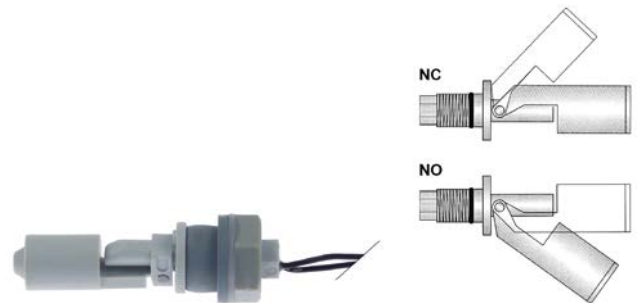

1

No.	347654	Ref. No.	07504A
description	float switch thread M16x2 1NO or 1NC ø 17mm L 70mm mounting ø 16mmVA cable cable length 500mm		





cam switches

on/off



1

No.	300020	Ref. No.	ELE0085
description	cam switch 4 operating positions 2NO sequence 0-1-0-1 16A shaft ø 6x4.6mm shaft L 23mm connection screw ceramic		
accessories for	300020		
	No.	110135	Ref. No. —
	rosette knob up to ø 52mm		
	No.	110231	Ref. No. —
	knob switch 0-1-0-1 t.max.°C ø 50mm shaft ø 6x4.6mm shaft flat upper black		



1

No.	300021	Ref. No.	ELE0083
description	cam switch 4 operating positions 4NO sequence 0-1-0-1 16A shaft ø 6x4.6mm shaft L 23mm connection screw ceramic		

4-position



1

No.	300103	Ref. No.	02093A
description	cam switch 4 operating positions 1NO/2CO sequence 0-1-2-3 2A shaft ø 6x4.6mm shaft L 23mm connection screw ceramic		

control equipment

MAFELEC

switches (complete)



1

No.	347743	Ref. No.	03967A
description	push button mounting measurements ø22mm 1NO 20A red complete		

rotary switches









1

No.	347744	Ref. No.	02104A
description	rotary selector mounting measurements ø22mm 2NO black sequence 0-1 complete		

lamps



1

No.	359607	Ref. No.	2835A
description	neon light bulb socket Ba9s 380V 2W clear ø 10mm L 28mm		
accessories for	359607		
	No.	359060	Ref. No. —
	lamp socket mounting measurements ø16.2mm socket E10 connection screw		
	No.	359063	Ref. No. —
	lamp socket mounting measurements ø19.2mm socket E14 connection screw		
	No.	359064	Ref. No. —
	lamp socket mounting measurements ø22.3mm socket E14 connection screw 250/380V ambient temperature at 1W 100°C ambient temperature at 2W 85°C		
	No.	359685	Ref. No. —
	lamp socket mounting measurements ø16.2mm socket E10		
	No.	359832	Ref. No. —
	lamp socket mounting measurements ø16.2mm socket Ba9s connection male faston 6.3mm		
	No.	359853	Ref. No. —
	lamp socket mounting measurements ø18.2mm socket Ba9s connection male faston 6.3mm		
	No.	359988	Ref. No. —
	lamp socket mounting measurements ø30.5mm 250V connection F6.3 temp.-resist. 55°C E14		



lamps

indicator lights



indicator lights 3-piece (housing, lens and bulb)

lamps

neon light bulbs









1

No.	359585	Ref. No.	02141A
description	neon light bulb socket E10 230V green ø 10mm L 28mm		
accessories for	359585		
	No.	359060	Ref. No. —
	lamp socket mounting measurements ø16.2mm socket E10 connection screw		
	No.	359685	Ref. No. —
	lamp socket mounting measurements ø16.2mm socket E10		









1

No.	359607	Ref. No.	2835A
description	neon light bulb socket Ba9s 380V 2W clear ø 10mm L 28mm		
accessories for	359607		
	No.	359060	Ref. No. —
	lamp socket mounting measurements ø16.2mm socket E10 connection screw		
	No.	359063	Ref. No. —
	lamp socket mounting measurements ø19.2mm socket E14 connection screw		
	No.	359064	Ref. No. —
	lamp socket mounting measurements ø22.3mm socket E14 connection screw 250/380V ambient temperature at 1W 100°C ambient temperature at 2W 85°C		
	No.	359685	Ref. No. —
	lamp socket mounting measurements ø16.2mm socket E10		
	No.	359832	Ref. No. —
	lamp socket mounting measurements ø16.2mm socket Ba9s connection male faston 6.3mm		
	No.	359853	Ref. No. —
	lamp socket mounting measurements ø18.2mm socket Ba9s connection male faston 6.3mm		
	No.	359988	Ref. No. —
	lamp socket mounting measurements ø30.5mm 250V connection F6.3 temp.-resist. 55°C E14		



1

No.	359601	Ref. No.	02142A
description	neon light bulb socket E10 380V clear ø 10mm L 28mm glas		
accessories for	359601		
	No.	359060	Ref. No. —
	lamp socket mounting measurements ø16.2mm socket E10 connection screw		
	No.	359063	Ref. No. —
	lamp socket mounting measurements ø19.2mm socket E14 connection screw		
	No.	359064	Ref. No. —
	lamp socket mounting measurements ø22.3mm socket E14 connection screw 250/380V ambient temperature at 1W 100°C ambient temperature at 2W 85°C		
	No.	359685	Ref. No. —
	lamp socket mounting measurements ø16.2mm socket E10		
	No.	359832	Ref. No. —
	lamp socket mounting measurements ø16.2mm socket Ba9s connection male faston 6.3mm		
	No.	359853	Ref. No. —
	lamp socket mounting measurements ø18.2mm socket Ba9s connection male faston 6.3mm		
	No.	359988	Ref. No. —
	lamp socket mounting measurements ø30.5mm 250V connection F6.3 temp.-resist. 55°C E14		

indicator lights (complete)

ø12mm

with screw socket



1

No.	359048	Ref. No.	07664A
description	indicator light ø 12mm 230V yellow connection male faston 6.3mm		



1

No.	359895	Ref. No.	07139A
description	indicator light ø 12mm 400V yellow connection cable 200mm		





1









No.	359894	Ref. No.	07136A
description	indicator light ø 12mm 400V red connection cable 200mm		











screw-on/push-on fit

neon light bulbs

			
1			
No.	359585	Ref. No.	02141A
description	neon light bulb socket E10 230V green ø 10mm L 28mm		
accessories for	359585		
	No.	359060	Ref. No.
	lamp socket mounting measurements ø16.2mm socket E10 connection screw		
	No.	359685	Ref. No.
	lamp socket mounting measurements ø16.2mm socket E10		

			
1			
No.	359607	Ref. No.	2835A
description	neon light bulb socket Ba9s 380V 2W clear ø 10mm L 28mm		
accessories for	359607		
	No.	359060	Ref. No.
	lamp socket mounting measurements ø16.2mm socket E10 connection screw		
	No.	359063	Ref. No.
	lamp socket mounting measurements ø19.2mm socket E14 connection screw		
	No.	359064	Ref. No.
	lamp socket mounting measurements ø22.3mm socket E14 connection screw 250/380V ambient temperature at 1W 100°C ambient temperature at 2W 85°C		
	No.	359685	Ref. No.
	lamp socket mounting measurements ø16.2mm socket E10		
	No.	359832	Ref. No.
	lamp socket mounting measurements ø16.2mm socket Ba9s connection male faston 6.3mm		
	No.	359853	Ref. No.
	lamp socket mounting measurements ø18.2mm socket Ba9s connection male faston 6.3mm		
	No.	359988	Ref. No.
	lamp socket mounting measurements ø30.5mm 250V connection F6.3 temp.-resist. 55°C E14		

			
1			
No.	359601	Ref. No.	02142A
description	neon light bulb socket E10 380V clear ø 10mm L 28mm glas		
accessories for	359601		
	No.	359060	Ref. No.
	lamp socket mounting measurements ø16.2mm socket E10 connection screw		
	No.	359063	Ref. No.
	lamp socket mounting measurements ø19.2mm socket E14 connection screw		

accessories for	359601		
	No.	359064	Ref. No.
	lamp socket mounting measurements ø22.3mm socket E14 connection screw 250/380V ambient temperature at 1W 100°C ambient temperature at 2W 85°C		
	No.	359685	Ref. No.
	lamp socket mounting measurements ø16.2mm socket E10		
	No.	359832	Ref. No.
	lamp socket mounting measurements ø16.2mm socket Ba9s connection male faston 6.3mm		
	No.	359853	Ref. No.
	lamp socket mounting measurements ø18.2mm socket Ba9s connection male faston 6.3mm		
	No.	359988	Ref. No.
	lamp socket mounting measurements ø30.5mm 250V connection F6.3 temp.-resist. 55°C E14		

timers

audible timers

			
1			
No.	350014	Ref. No.	02167A
description	audible timer operation time 15min ø 56mm shaft ø 6x4.6mm shaft L 24mm mounting distance 28mm		

			
1			
No.	350189	Ref. No.	02167A
description	audible timer operation time 15min ø 61mm shaft ø 6x4.6mm shaft L 24mm mounting distance 28.5mm		



contactors

ABB

power contactors



No.	381011	Ref. No.	07679A
description	power contactor resistive load 16A 230VAC (AC3/400V) 9A/4kW main contacts 2NO/2NC auxiliary contacts connection screw connection type B6-22-00		



No.	380117	Ref. No.	07667A
description	power contactor resistive load 25A 230VAC (AC3/400V) 9A/4kW main contacts 4NO auxiliary contacts connection screw connection type A9-40-00		

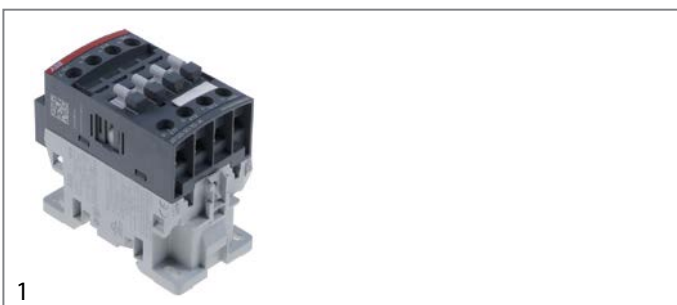

No.	381122	Ref. No.	00080A
description	power contactor resistive load 25A 250-500V AC/DC (AC3/400V) 9A/4kW main contacts 3NO auxiliary contacts 1NO connection screw connection type AF09-30-10-14		

relays

power relays

with bracket mounting

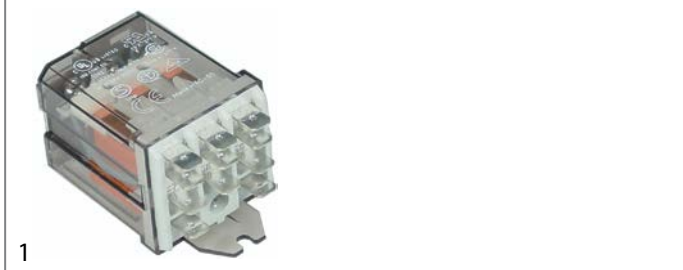

No.	380403	Ref. No.	07660A
description	power relays FINDER 230VAC 16A 3CO connection F6.3 bracket mounting manuf. no. 62.83.8.230.0500		

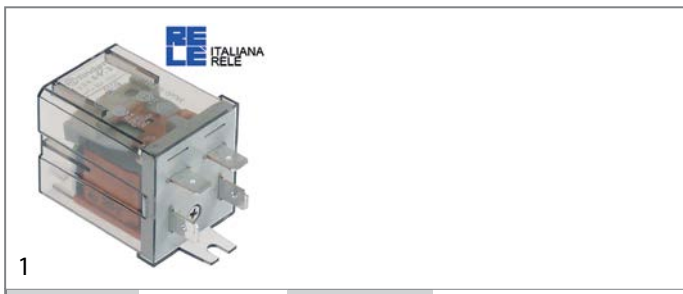

No.	380185	Ref. No.	07661A
description	power relays Italiana Relè 230VAC 30A 1NO connection F6.3 bracket mounting dimensions 36.5x32.2x51.8mm manuf. no. A10-230AC-FA		

level relays

miscellaneous



No.	380961	Ref. No.	02681A
description	level controller 1-pole 230V voltage AC type CNRVA1 FLT		

probes

producer-specific probes

probes















No.	379824	Ref. No.	07666A
description	temperature probe thermocouple K (NiCr-Ni) cable Vetrotex probe -50 up to 1150°C cable -50 up to +350°C connection 2-wire thread probe ø4x65mm cable length 2.35m		









solenoid valves

solenoid valves (water)

ELBI			
straight			
			
No.	373017	Ref. No.	07662A
description	solenoid valve single straight 230VAC inlet 3/4" outlet 11.5mm DN10 ELBI		
spare parts for	373017		
	No.	370467	Ref. No. —
solenoid valve filter suitable for ELBI			

TP			
			
No.	370017	Ref. No.	07662A
description	solenoid valve single straight 230VAC inlet 3/4" outlet 11.5mm DN10 TP p max 10bar		
spare parts for	370017		
	No.	371013	Ref. No. —
solenoid coil TP 230VAC 50/60Hz			
accessories for	370017		
	No.	371220	Ref. No. —
reducer TP flow rate 3l/min red tolerance ±15%			
	No.	371221	Ref. No. —
reducer TP flow rate 5.5l/min yellow tolerance ±15%			
	No.	371222	Ref. No. —
reducer TP flow rate 6l/min grey tolerance ±15%			
	No.	371223	Ref. No. —
reducer TP flow rate 10l/min white tolerance ±15%			
	No.	371224	Ref. No. —
reducer TP flow rate 12l/min bronze tolerance ±15%			
	No.	371225	Ref. No. —
reducer TP flow rate 16l/min light brown tolerance ±15%			
	No.	371226	Ref. No. —
reducer TP flow rate 20l/min red tolerance ±15%			
	No.	371230	Ref. No. —
reducer TP flow rate 0.25l/min red tolerance ±25%			

accessories for	370017		
	No.	371231	Ref. No. —
reducer TP flow rate 0.35l/min violet tolerance ±25%			
	No.	371232	Ref. No. —
reducer TP flow rate 0.5l/min orange tolerance ±25%			
	No.	371233	Ref. No. —
reducer TP flow rate 0.8l/min white tolerance ±25%			
	No.	371234	Ref. No. —
reducer TP flow rate 1l/min light blue tolerance ±25%			
	No.	371235	Ref. No. —
reducer TP flow rate 1.2l/min brown tolerance ±25%			
	No.	371236	Ref. No. —
reducer TP flow rate 1.5l/min light brown tolerance ±25%			
	No.	371237	Ref. No. —
reducer TP flow rate 2.5l/min yellow tolerance ±25%			
	No.	371238	Ref. No. —
reducer TP flow rate 3.4l/min dark green tolerance ±25%			
	No.	371239	Ref. No. —
reducer TP flow rate 5l/min black tolerance ±25%			
	No.	371240	Ref. No. —
reducer TP flow rate 8l/min blue tolerance ±20%			



metal

SIRAI

solenoid valves steam (water)

2-way

L153-D series

			
No.	370326	Ref. No.	—
description	solenoid valve 2-ways 230VAC connection 1" L 105mm DN 22mm slide-on receptacle DIN -10 up to 140°C SIRAI type series L153-D coil type Z914A membranes EPDM (steam/water) p max 8bar p min 0.1bar		
spare parts for	370326		
	No.	371161	Ref. No. —
solenoid coil 230VAC 27VA SIRAI coil type Z923A seat ø 16mm 50Hz			



solenoid valves (refrigeration)

CASTEL

spare parts and accessories



1

No.	371090	Ref. No.	—
description	power socket plug type DIN 43650A screw		

pressure switches

for gas equipment



1

No.	541051	Ref. No.	07835A
description	pressure control ø 45mm pressure range adjustable 10-50mbar pressure connection vertical gas technology connection 1/4" pressure connection ø 1/4"mm		

for steam control



1

No.	541769	Ref. No.	07399A
description	pressure control ø 45mm kettle pressure range up to 1.0bar connection 1/4" 250V 8A p max 1bar pressure connection 1/4"		



1

No.	541074	Ref. No.	08030A
description	pressure control ø 45mm triggering pressure 0.5bar reset pressure 0.35bar pressure connection vertical steam control pressure range 0.35/0.51bar connection 1/8" pressure connection 1/8"		

electric accessories

cables

copper wire

up to 280°C



1

No.	550588	Ref. No.	02356A
description	copper wire 6mm ² permanent temperature -60 up to +280°C conductor nickel-plated copper wire insulation glass fibre braiding/silicone rubber Qty 10m brown t.max. 350°C rated 300/500V test voltage 2000V		

nickel wire

up to 350°C



1

No.	550089	Ref. No.	02353A 02361A
description	nickel wire 4mm ² brown Qty 10m permanent temperature -60 up to +350°C t.max. 400°C rated 300/500V test voltage 2000V conductor nickel wire insulation glass fibre braiding/silicone rubber		



1

No.	550590	Ref. No.	02356A 02364A
description	nickel wire 6mm ² brown Qty 10m permanent temperature -60 up to +350°C t.max. 400°C rated 300/500V test voltage 2000V conductor nickel wire insulation glass fibre braiding/silicone rubber		

accessories

protection hoses



1

No.	550035	Ref. No.	02385A
description	protective metal tube PG21 ID ø 23mm ED ø 27mm zinc-coated steel Qty 10m		

accessories for



No.	550308	Ref. No.	—
description	screw connection for protection hose PG21 ID ø 21.7mm ED ømm nickel-plated brass Qty 5 pieces		













cable glands			
threaded cable glands			
screw connections			
			
1			
No.	550571	Ref. No.	02404A
description	cable gland thread PG16 cable ø 12.0-14.0mm mounting ø 21.5mm nickel-plated brass Qty 1 pcs		

fastening nuts			
			
1			
No.	550577	Ref. No.	02407A
description	nut thread PG16 H 3mm WS 26 nickel-plated brass Qty 1 pcs mounting ømm cable ømm		

gas taps



PEL

20S series			
			
1			
No.	101491	Ref. No.	08369A
description	gas tap PEL type 20S gas inlet M16x1.5 (tube ø 10mm) bypass nozzle ø 0.35mm gas outlet M16x1.5 (tube ø 10/8mm) thermocouple connection M9x1 pilot connection shaft ø 8x6.5mm shaft L 22/15mm shaft flat lower		
spare parts for	101491		
			
No.	100408	Ref. No.	—
bypass nozzle type PEL20/21 bore ø 0.35mm thread M5x0.5			
			
No.	101060	Ref. No.	00366A
magnet unit standard L 39mm D1 ø 15.4mm D2 ø 11mm suitable for PEL20-21/JUNKERS/EGA			
			
No.	101205	Ref. No.	—
gas tap front part shaft ø 8x6.5mm shaft L 22/15mm shaft flat upper/lower suitable for PEL20			
			
No.	101231	Ref. No.	—
thermocouple nut T1: M9x1 T2: M18x1			
accessories for	101491		
			
No.	101287	Ref. No.	—
olive for pipe ø 6mm Qty 1 pcs			
			
No.	101300	Ref. No.	—
union nut thread M16x1.5 tube ø 10mm			
			
No.	101450	Ref. No.	—
olive for pipe ø 8mm L 12.7mm Qty 1 pcs ED ø 10mm			

accessories for	101491		
			
No.	101451	Ref. No.	—
union nut thread M16x1.5 tube ø 8mm			
			
No.	110081	Ref. No.	—
knob ø 70mm shaft ø 8x6.5mm shaft flat universal			
			
No.	110083	Ref. No.	—
knob dial plate gas tap without ignition flame silver			

21S series			
			
1			
No.	101095	Ref. No.	08366A
description	gas tap PEL type 21S gas inlet M16x1.5 (tube ø 10mm) bypass nozzle ø 0.35mm gas outlet M16x1.5 (tube ø 10/8mm) thermocouple connection M8x1 pilot connection M10x1 shaft ø 8x6.5mm shaft L 22/15mm shaft flat lower		
spare parts for	101095		
			
No.	100408	Ref. No.	—
bypass nozzle type PEL20/21 bore ø 0.35mm thread M5x0.5			
			
No.	101060	Ref. No.	00366A
magnet unit standard L 39mm D1 ø 15.4mm D2 ø 11mm suitable for PEL20-21/JUNKERS/EGA			
			
No.	101206	Ref. No.	—
gas tap front part shaft ø 8x6.5mm shaft L 22/15mm shaft flat upper/lower suitable for PEL21			
			
No.	101230	Ref. No.	—
thermocouple nut T1: M8x1 T2: M18x1 aluminium			
accessories for	101095		
			
No.	100908	Ref. No.	—
union screw thread M10x1 for pipe ø 4mm Qty 1 pcs			
			
No.	100909	Ref. No.	07011A
union screw thread M10x1 for pipe ø 6mm Qty 1 pcs			
			
No.	101246	Ref. No.	—
olive for pipe ø 4mm Qty 1 pcs			
			
No.	101278	Ref. No.	—
olive for pipe ø 10mm Qty 1 pcs			
			
No.	101286	Ref. No.	05377A
olive ID ø 6mm Qty 1 pcs			
			
No.	101300	Ref. No.	—
union nut thread M16x1.5 tube ø 10mm			
			
No.	101450	Ref. No.	—
olive for pipe ø 8mm L 12.7mm Qty 1 pcs ED ø 10mm			



Table continues overleaf

accessories for 101095				
	No.	101451	Ref. No.	—
union nut thread M16x1.5 tube ø 8mm				
	No.	110081	Ref. No.	—
knob ø 70mm shaft ø 8x6.5mm shaft flat universal				
	No.	112206	Ref. No.	—
knob dial plate silver gas tap PEL21/22/23 t.max.°C ED ø 63mm ID ø 45.5mm				

22N/O series





No.	101443	Ref. No.	00310A	
description	gas tap PEL type 22N/O gas inlet M20x1.5 (tube ø 12mm) bypass nozzle ø 0.35mm gas outlet M20x1.5 (tube ø 12/10mm) thermocouple connection pilot connection M10x1 shaft ø 10x8mm shaft L 25/17mm shaft flat lower			
spare parts for 101443				
	No.	100259	Ref. No.	—
bypass nozzle type PEL22 bore ø 0.35mm thread M6x0.5				
	No.	101201	Ref. No.	—
gas tap front part shaft ø 10x8mm shaft L 25/17mm shaft flat upper/lower suitable for PEL22				
	No.	101240	Ref. No.	—
gas connection thread M20x1.5 tube ø 12/10mm for PEL gas taps with gasket and screws horizontal				
	No.	101460	Ref. No.	—
O-ring ø 12.37mm D1 ø 2.62mm suitable for PEL22				
	No.	101461	Ref. No.	—
screw kit suitable for PEL22 Qty 4 pcs				
accessories for 101443				
	No.	100908	Ref. No.	—
union screw thread M10x1 for pipe ø 4mm Qty 1 pcs				
	No.	100909	Ref. No.	07011A
union screw thread M10x1 for pipe ø 6mm Qty 1 pcs				
	No.	101246	Ref. No.	—
olive for pipe ø 4mm Qty 1 pcs				
	No.	101248	Ref. No.	07475A
olive for pipe ø 12mm Qty 1 pcs suitable for PEL				
	No.	101249	Ref. No.	01600A
olive for pipe ø 10mm Qty 1 pcs				
	No.	101250	Ref. No.	07463A
union nut thread M20x1.5 for pipe ø 10mm				

accessories for 101443				
	No.	101251	Ref. No.	07462A
union nut thread M20x1.5 for pipe ø 12mm				
	No.	101286	Ref. No.	05377A
olive ID ø 6mm Qty 1 pcs				

22S/O series



No.	101086	Ref. No.	06635A	
description	gas tap PEL type 22S/O gas inlet M20x1.5 (tube ø 12mm) bypass nozzle ø 0.35mm gas outlet M20x1.5 (tube ø 12/10mm) thermocouple connection M9x1 pilot connection M10x1 shaft ø 10x8mm shaft L 25/17mm shaft flat lower			
spare parts for 101086				
	No.	100259	Ref. No.	—
bypass nozzle type PEL22 bore ø 0.35mm thread M6x0.5				
	No.	101058	Ref. No.	00325A
magnet unit L 39mm D1 ø 15.4mm D2 ø 13.5mm suitable for PEL22/EGA24197 standard				
	No.	101201	Ref. No.	—
gas tap front part shaft ø 10x8mm shaft L 25/17mm shaft flat upper/lower suitable for PEL22				
	No.	101231	Ref. No.	—
thermocouple nut T1: M9x1 T2: M18x1				
	No.	101240	Ref. No.	—
gas connection thread M20x1.5 tube ø 12/10mm for PEL gas taps with gasket and screws horizontal				
	No.	101460	Ref. No.	—
O-ring ø 12.37mm D1 ø 2.62mm suitable for PEL22				
	No.	101461	Ref. No.	—
screw kit suitable for PEL22 Qty 4 pcs				
accessories for 101086				
	No.	100908	Ref. No.	—
union screw thread M10x1 for pipe ø 4mm Qty 1 pcs				
	No.	100909	Ref. No.	07011A
union screw thread M10x1 for pipe ø 6mm Qty 1 pcs				
	No.	101241	Ref. No.	—
gas connection thread M20x1.5 tube ø 12/10mm for PEL gas taps vertical				
	No.	101246	Ref. No.	—
olive for pipe ø 4mm Qty 1 pcs				
	No.	101248	Ref. No.	07475A
olive for pipe ø 12mm Qty 1 pcs suitable for PEL				
	No.	101249	Ref. No.	01600A
olive for pipe ø 10mm Qty 1 pcs				



accessories for		101086		
No.		101250	Ref. No.	07463A
	union nut thread M20x1.5 for pipe ø 10mm			
No.		101251	Ref. No.	07462A
	union nut thread M20x1.5 for pipe ø 12mm			
No.		101286	Ref. No.	05377A
	olive ID ø 6mm Qty 1 pcs			
No.		110080	Ref. No.	—
	knob ø 70mm shaft ø 10x8mm shaft flat universal			
No.		112206	Ref. No.	—
	knob dial plate silver gas tap PEL21/22/23 t.max.°C ED ø 63mm ID ø 45.5mm			

accessories for		101949		
No.		101250	Ref. No.	07463A
	union nut thread M20x1.5 for pipe ø 10mm			
No.		101251	Ref. No.	07462A
	union nut thread M20x1.5 for pipe ø 12mm			
No.		101286	Ref. No.	05377A
	olive ID ø 6mm Qty 1 pcs			
No.		110080	Ref. No.	—
	knob ø 70mm shaft ø 10x8mm shaft flat universal			
No.		112206	Ref. No.	—
	knob dial plate silver gas tap PEL21/22/23 t.max.°C ED ø 63mm ID ø 45.5mm			

1				
No.	101949	Ref. No.	00311A	
description	gas tap PEL type 22S/O gas inlet M20x1.5 (tube ø 12mm) bypass nozzle ø 0mm gas outlet M20x1.5 (tube ø 12/10mm) thermocouple connection M9x1 pilot connection M10x1 shaft ø 10x8mm shaft L 25/17mm shaft flat lower			
spare parts for	101949			
	No.	101058	Ref. No.	00325A
	magnet unit L 39mm D1 ø 15.4mm D2 ø 13.5mm suitable for PEL22/ EGA24197 standard			
	No.	101231	Ref. No.	—
	thermocouple nut T1: M9x1 T2: M18x1			
	No.	101235	Ref. No.	—
	gas connection thread M20x1.5 tube ø 12/10mm for PEL gas taps horizontal			
	No.	101460	Ref. No.	—
	O-ring ø 12.37mm D1 ø 2.62mm suitable for PEL22			
	No.	101461	Ref. No.	—
	screw kit suitable for PEL22 Qty 4 pcs			
accessories for		101949		
	No.	100908	Ref. No.	—
	union screw thread M10x1 for pipe ø 4mm Qty 1 pcs			
	No.	100909	Ref. No.	07011A
	union screw thread M10x1 for pipe ø 6mm Qty 1 pcs			
	No.	101246	Ref. No.	—
	olive for pipe ø 4mm Qty 1 pcs			
	No.	101248	Ref. No.	07475A
	olive for pipe ø 12mm Qty 1 pcs suitable for PEL			
	No.	101249	Ref. No.	01600A
	olive for pipe ø 10mm Qty 1 pcs			

23S/O series				
1				
No.	101091	Ref. No.	00312A	
description	gas tap PEL type 23S/O gas inlet M28x1.5 (tube ø 20mm) bypass nozzle ø 0.35mm gas outlet M24x1.5 (tube ø 16mm) thermocouple connection M9x1 pilot connection M10x1 shaft ø 10x8mm shaft L 35/19mm shaft flat upper			
spare parts for	101091			
	No.	100455	Ref. No.	—
	bypass nozzle type PEL23/24 bore ø 0.35mm thread M8x0.5			
	No.	101045	Ref. No.	00394A
	magnet unit T1: M9x1 T2: M22x1 L 46mm ø 18mm suitable for PEL23S M9x1			
	No.	101244	Ref. No.	—
	gas connection thread M24x1.5 tube ø 12/16mm horizontal for PEL gas taps			
	No.	101336	Ref. No.	—
	gas tap front part shaft ø 10x8mm shaft L 35/17mm shaft flat upper/lower suitable for PEL23S			
	No.	101463	Ref. No.	—
	screw suitable for PEL23S Qty 4 pcs			
	No.	528455	Ref. No.	—
	O-ring Viton thickness 2.62mm ID ø 18.72mm Qty 1 pcs			
accessories for		101091		
	No.	100908	Ref. No.	—
	union screw thread M10x1 for pipe ø 4mm Qty 1 pcs			
	No.	100909	Ref. No.	07011A
	union screw thread M10x1 for pipe ø 6mm Qty 1 pcs			
	No.	101246	Ref. No.	—
	olive for pipe ø 4mm Qty 1 pcs			

Table continues overleaf





accessories for		101091		
No.	Ref. No.			
	101252	Ref. No.		—
union nut thread M24x1.5 for pipe ø 12mm				
	101253	Ref. No.		—
union nut thread M24x1.5 PEL for pipe ø 16mm				
	101254	Ref. No.		—
union nut thread M28x1.5 tube ø 20mm				
	101255	Ref. No.		—
olive for pipe ø 12mm Qty 1 pcs				
	101256	Ref. No.		—
olive for pipe ø 16mm Qty 1 pcs				
	101257	Ref. No.		—
olive for pipe ø 20mm Qty 1 pcs				
	101286	Ref. No.		05377A
olive ID ø 6mm Qty 1 pcs				
	110080	Ref. No.		—
knob ø 70mm shaft ø 10x8mm shaft flat universal				
	112206	Ref. No.		—
knob dial plate silver gas tap PEL21/22/23 t.max.°C ED ø 63mm ID ø 45.5mm				

PEL 355



1

No.	Ref. No.			
	107227	Ref. No.		08425A
description gas tap PEL type 355 gas inlet M20x1.5 (tube ø 12mm) bypass nozzle ø 0mm gas outlet M20x1.5 (tube ø 12/10mm) thermocouple connection M9x1 pilot connection M10x1 shaft ø 10x8mm shaft L 27/17mm shaft flat left				
spare parts for 107227				
	106819	Ref. No.		—
solenoid valve body				
	371090	Ref. No.		—
power socket plug type DIN 43650A screw				
	371157	Ref. No.		—
solenoid coil t.max. 125°C 230V seat ø 13mm 17VA				

STN3R



1

No.	Ref. No.			
	106185	Ref. No.		00273A
description gas tap STN3R gas inlet pipe flange ø20mm bypass nozzle ø 0mm gas outlet 3/8" (tube ø 12mm) thermocouple connection M9x1 pilot connection M10x1 shaft ø 7x7mm shaft L 22/6mm shaft flat horizontal				
spare parts for 106185				
	101964	Ref. No.		—
clamping bracket				



1

No.	Ref. No.			
	103108	Ref. No.		00549A 05071A
description gas tap STN3R type 300 gas inlet 1/2" IT bypass nozzle ø 0mm gas outlet 1/2" IT thermocouple connection M9x1 pilot connection M10x1 shaft ø 10x8mm shaft L 36/19mm shaft flat lower with accessories incl. adapt. M28x1.5 (tube ø20mm)				



gas thermostats

SIT

710 Minisit series



1

No.	Ref. No.			
	106931	Ref. No.		00308A
description gas thermostat SIT type MINISIT 710 t.max. 310°C 70-310°C gas inlet 1/2" gas outlet 3/8" thermocouple connection M9x1 pilot connection M10x1 probe ø 4mm probe L 72mm capillary pipe 1300mm pressure controller no pressure regulator bar gland nut 0710647 ignition gas 6mm probe material stainless steel				
accessories for 106931				
	101137	Ref. No.		—
cover cap without piezoelectric igniter				
	110068	Ref. No.		—
knob suitable for Minisit ø 37mm				



No.	101131	Ref. No.	00306A
description	gas thermostat without cap, button and angle SIT type MINISIT 710 t.max. 190°C 50-190°C gas inlet 1/2" gas outlet 3/8" thermocouple connection M9x1 pilot connection M10x1 probe ø 5mm probe L 98mm capillary pipe 1200mm probe type type A2 pressure controller no pressure regulator bar gland nut		
spare parts for	101131		
	No.	101053	Ref. No. —
	magnet unit T1: M9x1 T2: M24x1 L 45mm ø 17mm suitable for Minisit		
	No.	102103	Ref. No. —
	probe 60-200°C probe ø 5mm probe L 98mm capillary pipe 1050mm t.max. 200°C fryer probe type type A2 suitable for MINISIT 710		
accessories for	101131		
	No.	100809	Ref. No. —
	O-ring EPDM thickness 2mm ID ø 21mm Qty 1 pcs		
	No.	100820	Ref. No. —
	gland duct ET M14x1.5 IT M10x0.75 probe ø max. 6.5mm WS 22		
	No.	100904	Ref. No. —
	locking screw M10x1 for pipe ø 4mm Qty 1 pcs		
	No.	100905	Ref. No. —
	locking screw M10x1 for pipe ø 6mm Qty 1 pcs		
	No.	101054	Ref. No. —
	magnet unit T1: M10x1 T2: M24x1 L 45mm ø 17mm suitable for Minisit		
	No.	101136	Ref. No. —
	piezoelectric igniter suitable for Minisit with cover cap ømm connection F6.3x0.8		
	No.	101137	Ref. No. —
	cover cap without piezoelectric igniter		
	No.	101267	Ref. No. —
	reducer IT 3/8" ET 1/2" L 21mm		
	No.	101268	Ref. No. —
	gas connection thread 3/8" angled with O-ring MINISIT 710		
	No.	101269	Ref. No. 00442A
	gas connection thread 1/2" angled with O-ring MINISIT 710		
	No.	101270	Ref. No. —
	screw connection IT 3/8" ET 3/8" L 28mm		
	No.	101272	Ref. No. —
	screw connection IT 1/2" ET 3/8" L 57mm		
	No.	101273	Ref. No. —
	olive for pipe ø 12mm L 9.5mm brass Qty 1 pcs suitable for universal		

















accessories for	101131		
	No.	101274	Ref. No. —
	olive for pipe ø 16mm Qty 1 pcs		
	No.	101275	Ref. No. —
	union screw thread 1/2" for pipe ø 16mm Qty 1 pcs		
	No.	101276	Ref. No. —
	union screw thread 3/8" tube ø 12mm Qty 1 pcs		
	No.	110068	Ref. No. —
	knob suitable for Minisit ø 37mm		

No.	107237	Ref. No.	00306A
description	gas thermostat without cap, button and angle SIT type MINISIT 710 t.max. 210°C 70-210°C gas inlet 1/2" gas outlet 3/8" thermocouple connection M9x1 pilot connection M10x1 probe ø 4mm probe L 122mm capillary pipe 1300mm probe type pressure controller no pressure regulator bar gland nut		
accessories for	107237		
	No.	101137	Ref. No. —
	cover cap without piezoelectric igniter		
	No.	101267	Ref. No. —
	reducer IT 3/8" ET 1/2" L 21mm		
	No.	101268	Ref. No. —
	gas connection thread 3/8" angled with O-ring MINISIT 710		
	No.	110068	Ref. No. —
	knob suitable for Minisit ø 37mm		

PEL



24STS series

No.	107228	Ref. No.	00473A
description	gas thermostat PEL type 24STS 110-310°C gas inlet flange bypass nozzle ø 1.1mm gas outlet flange thermocouple connection M9x1 pilot connection M10x1 capillary pipe 1200mm probe ø 6mm probe L 100mm shaft ø 10x8mm shaft L 27/17mm shaft flat upper		



			
No.	101159	Ref. No.	473A
description	gas thermostat PEL type 24STS 120-320°C gas inlet flange bypass nozzle ø 0.35mm gas outlet flange thermocouple connection M9x1 pilot connection M10x1 capillary pipe 1200mm probe ø 6mm probe L 100mm shaft ø 10x8mm shaft L 27/17mm shaft flat upper		
spare parts for	101159		
	No.	100455	Ref. No. —
bypass nozzle type PEL23/24 bore ø 0.35mm thread M8x0.5			
	No.	101058	Ref. No. 00325A
magnet unit L 39mm D1 ø 15.4mm D2 ø 13.5mm suitable for PEL22/ EGA24197 standard			
	No.	106200	Ref. No. —
nut thread M9x1 suitable for PEL 24/25S			
accessories for	101159		
	No.	101235	Ref. No. —
gas connection thread M20x1.5 tube ø 12/10mm for PEL gas taps horizontal			
	No.	101236	Ref. No. —
gas connection thread M20x1.5 tube ø 12/10mm for PEL gas taps vertical			
	No.	101240	Ref. No. —
gas connection thread M20x1.5 tube ø 12/10mm for PEL gas taps with gasket and screws horizontal			
	No.	101241	Ref. No. —
gas connection thread M20x1.5 tube ø 12/10mm for PEL gas taps vertical			
	No.	101248	Ref. No. 07475A
olive for pipe ø 12mm Qty 1 pcs suitable for PEL			
	No.	101249	Ref. No. 01600A
olive for pipe ø 10mm Qty 1 pcs			
	No.	101250	Ref. No. 07463A
union nut thread M20x1.5 for pipe ø 10mm			
	No.	101251	Ref. No. 07462A
union nut thread M20x1.5 for pipe ø 12mm			
	No.	101356	Ref. No. —
gas tap PEL type 21S gas inlet M16x1.5 (tube ø 10mm) bypass nozzle ø 0.35mm gas outlet M16x1.5 (tube ø 10/8mm) thermocouple connection M10x1 pilot connection M10x1 shaft ø 8x6.5mm shaft L 22/15mm shaft flat lower			
	No.	101460	Ref. No. —
O-ring ø 12.37mm D1 ø 2.62mm suitable for PEL22			
	No.	101461	Ref. No. —
screw kit suitable for PEL22 Qty 4 pcs			
	No.	106165	Ref. No. —
gasket ø 27mm			
	No.	110079	Ref. No. —
knob dial plate gas thermostat 1-8 silver			

accessories for	101159		
	No.	110080	Ref. No. —
knob ø 70mm shaft ø 10x8mm shaft flat universal			



ROBERTSHAW



			
No.	580062	Ref. No.	00295A
description	gas thermostat type BJW 93-287°C 200-550°F gas inlet flange (tube ø 5/16") bypass nozzle ømm gas outlet 3/8" NPT thermocouple connection pilot connection 5/16" UNEF capillary pipe 48" - 1220mm probe ø 3/16" - 4.7mm probe L 11 1/4" - 285mm ROBERTSHAW pipe input ø 7/16" pipe output ø 7/16"		
accessories for	580062		
	No.	106659	Ref. No. —
gas connection suitable for thermostat			
	No.	112547	Ref. No. —
knob gas thermostat t.max. 500°F 200-500°F ø 49mm shaft ømm shaft flat ROBERTSHAW black			

STN3R

			
No.	106207	Ref. No.	00303A 104851
description	gas thermostat t.max. 110°C gas inlet 1/2" gas outlet 1/2" probe ø 6.5mm probe L 200mm capillary pipe 1200mm STN3R		
spare parts for	106207		
	No.	106211	Ref. No. —
knob suitable for STN3R			
	No.	106212	Ref. No. —
knob suitable for STN3R			

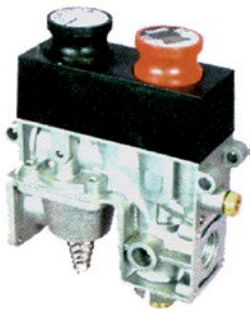

			
1			
No.	106208	Ref. No.	00300A
description	gas thermostat t.max. 200°C gas inlet 1/2" gas outlet 1/2" probe ø 6mm probe L 120mm capillary pipe 1200mm STN3R		
spare parts for	106208		
	No.	106211	Ref. No. —
	knob suitable for STN3R		
	No.	106212	Ref. No. —
	knob suitable for STN3R		



			
1			
No.	106209	Ref. No.	00304A
description	gas thermostat t.max. 300°C gas inlet 1/2" gas outlet 1/2" probe ø 6.5mm probe L 80mm capillary pipe 1200mm STN3R		
spare parts for	106209		
	No.	106211	Ref. No. —
	knob suitable for STN3R		
	No.	106212	Ref. No. —
	knob suitable for STN3R		

















ignition parts

pilot burners

SIT

100 series

			
1			
No.	106906	Ref. No.	00177A 07550A 7550P
description	pilot burner SIT type 100 series 3 flames nozzle ø 0.2mm gas connection 6mm		
spare parts for	106906		
	No.	100245	Ref. No. 01157A 07357A
	pilot burner nozzle LPG code 20 bore ø 0.2mm gas connection M8x0.75		

spare parts for	106906		
	No.	100855	Ref. No. —
	pilot burner bracket triple		
	No.	100885	Ref. No. —
	air mixing sleeve for pilot burner Qty 1 pcs		
	No.	100916	Ref. No. —
	compression spring for pilot burner Qty 1 pcs		
	No.	100917	Ref. No. —
	gasket for pilot burner Qty 1 pcs aluminium		
	No.	100918	Ref. No. —
	screw for pilot burner		
	No.	107162	Ref. No. —
	pilot burner cap SIT 3 flames Hmm Lmm Qty 1 pcs		
	No.	107701	Ref. No. —
	pilot burner bottom part SIT 100 series nozzle ø 0.2mm		
accessories for	106906		
	No.	100245	Ref. No. 01157A 07357A
	pilot burner nozzle LPG code 20 bore ø 0.2mm Qty 1 pcs thread M8x0.75		
	No.	100246	Ref. No. —
	pilot burner nozzle natural gas bore ø 0.35mm Qty 1 pcs thread M8x0.75		
	No.	100904	Ref. No. —
	locking screw M10x1 for pipe ø 4mm Qty 1 pcs		
	No.	100905	Ref. No. —
	locking screw M10x1 for pipe ø 6mm Qty 1 pcs		
	No.	102110	Ref. No. —
	pilot tube copper pipe ø 4mm thickness 1mm L 3000mm		
	No.	102111	Ref. No. —
	pilot tube copper pipe ø 6mm thickness 1mm L 3000mm		
	No.	107171	Ref. No. 7357A
	pilot burner nozzle SIT natural/liquid gas bore ø 0.25mm Qty 1 pcs		
	No.	107700	Ref. No. —
	pilot burner bottom part SIT 100 series nozzle ø 0.25mm		
	No.	107702	Ref. No. —
	pilot burner bottom part SIT 100 series nozzle ø 0.35mm		



No.	107225	Ref. No.	07551A
description	pilot burner SIT type 100 series 3 flames nozzle ϕ 0.4mm gas connection 6mm		

accessories

pilot burner nozzles



No.	100245	Ref. No.	01157A 07357A
description	pilot burner nozzle LPG code 20 bore ϕ 0.2mm Qty 1 pcs thread M8x0.75		



No.	102972	Ref. No.	06430A
description	pilot burner nozzle natural gas code 40 bore ϕ 0.4mm Qty 1 pcs		

ignition electrodes

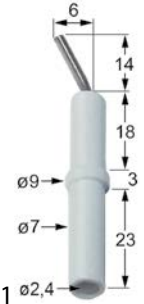

No.	100707	Ref. No.	05315A
description	ignition electrode D1 ϕ 7mm D2 ϕ 9mm connection ϕ 2.4mm L1 14mm L2 6mm BL1 18mm BL2 3mm BL3 23mm to clip Qty 1 pcs		

electrodes

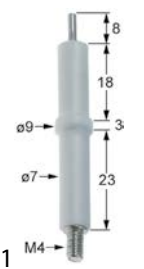

No.	102871	Ref. No.	07010A
description	ignition electrode D1 ϕ 7mm D2 ϕ 9mm connection M4 L1 8mm BL1 18mm BL2 3mm BL3 23mm to clip		

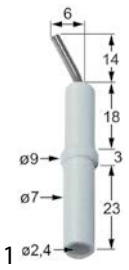

No.	100707	Ref. No.	05315A
description	ignition electrode D1 ϕ 7mm D2 ϕ 9mm connection ϕ 2.4mm L1 14mm L2 6mm BL1 18mm BL2 3mm BL3 23mm to clip Qty 1 pcs		

ignition cables

pre-assembled cables



No.	102163	Ref. No.	03013A
description	ignition cable cable length 1500mm connection F2.8mm / ϕ 2.4mm		

ignition units

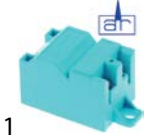

No.	101012	Ref. No.	02161A
description	ignition unit outputs 2 230VAC dimensions 48x32x32mm mounting distance 56mm inlet F2.8x0.8 outlet F2.8x0.8 type ZIG2 50-60Hz		



No.	101002	Ref. No.	02161A
description	ignition unit outputs 2 230VAC dimensions 88x23x34mm mounting distance 73mm inlet F6.3x0.8 outlet F2.8x0.8 0.6VA 50/60Hz		

thermocouples

thermocouple sets universal

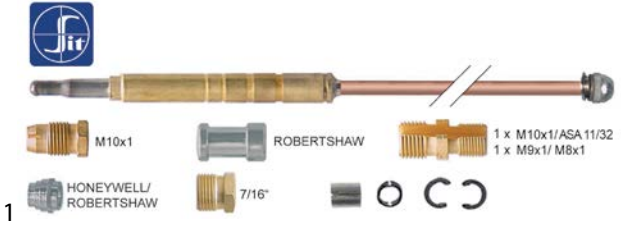

No.	107647	Ref. No.	00291A
description	thermocouple set SIT 11-piece L 900mm		





No.	102286	Ref. No.	5945A
description	thermocouple set 8-piece L 900mm flexible		

plug-in thermocouples

plug-in thermocouples standard

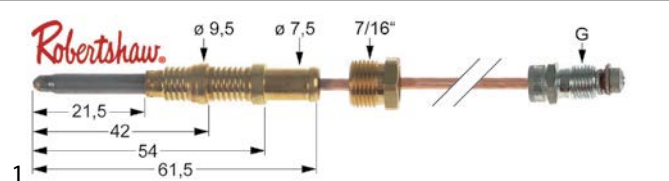
ROBERTSHAW



No.	102277	Ref. No.	286A
description	thermocouple ROBERTSHAW ASA 11/32 L 36" - 915mm 7/16"		

with barrel socket ø6(6.5)mm

thermocouples SIT

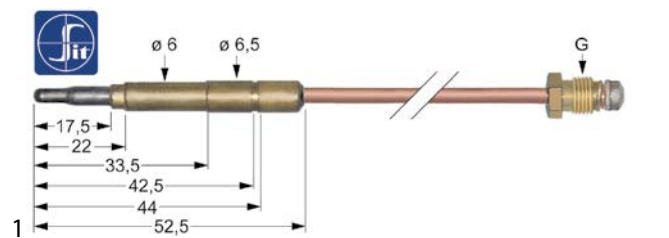

No.	107614	Ref. No.	00290A 00296A
description	thermocouple SIT M9x1 L 1500mm plug connection ø6.0(6.5)mm		

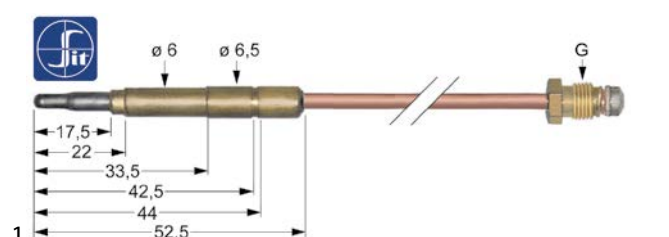

No.	107611	Ref. No.	00291A
description	thermocouple SIT M9x1 L 850mm plug connection ø6.0(6.5)mm		

accessories

interrupters



No.	101265	Ref. No.	05690A
description	interrupter thread M9x1		

gas burners

bar burners

bar burners



No.	109114	Ref. No.	30400010 505209
description	bar burner 1-row L 550mm Wmm ø 39mm Hmm flange connection tilting bratt pan		

gas nozzles

main nozzles

gas nozzles 3/8"



No.	107500	Ref. No.	00191A
description	gas injector thread 3/8" WS 17 bore ø 0.5mm		



No.	106526	Ref. No.	00263A
description	gas injector thread 3/8" WS 17 bore ø 0.6mm		

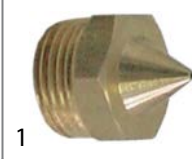

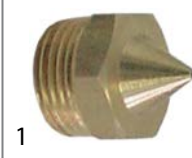

No.	106527	Ref. No.	00192A
description	gas injector thread 3/8" WS 17 bore ø 0.7mm		





No.	106528	Ref. No.	00264A
description	gas injector thread 3/8" WS 17 bore ø 0.8mm		

			
1			
No.	106532	Ref. No.	00194A
description	gas injector thread 3/8" WS 17 bore ø 1.1mm		

			
1			
No.	106540	Ref. No.	00202A
description	gas injector thread 3/8" WS 17 bore ø 1.8mm		

			
1			
No.	106534	Ref. No.	00195A
description	gas injector thread 3/8" WS 17 bore ø 1.2mm		

			
1			
No.	106541	Ref. No.	00203A
description	gas injector thread 3/8" WS 17 bore ø 1.9mm		

			
1			
No.	106535	Ref. No.	00197A 07280A
description	gas injector thread 3/8" WS 17 bore ø 1.3mm		

			
1			
No.	106531	Ref. No.	00193A
description	gas injector thread 3/8" WS 17 bore ø 1mm		

			
1			
No.	106536	Ref. No.	00198A
description	gas injector thread 3/8" WS 17 bore ø 1.4mm		

			
1			
No.	106543	Ref. No.	00205A G00205A
description	gas injector thread 3/8" WS 17 bore ø 2.1mm		

			
1			
No.	106537	Ref. No.	00199A
description	gas injector thread 3/8" WS 17 bore ø 1.5mm		

			
1			
No.	106544	Ref. No.	00206A
description	gas injector thread 3/8" WS 17 bore ø 2.2mm		

			
1			
No.	106538	Ref. No.	00200A
description	gas injector thread 3/8" WS 17 bore ø 1.6mm		

			
1			
No.	106545	Ref. No.	00207A
description	gas injector thread 3/8" WS 17 bore ø 2.3mm		

			
1			
No.	106539	Ref. No.	00201A
description	gas injector thread 3/8" WS 17 bore ø 1.7mm		

			
1			
No.	106546	Ref. No.	00208A
description	gas injector thread 3/8" WS 17 bore ø 2.4mm		





			
1			
No.	106547	Ref. No.	00209A
description	gas injector thread 3/8" WS 17 bore ø 2.5mm		

			
1			
No.	106555	Ref. No.	00216A
description	gas injector thread 3/8" WS 17 bore ø 3.2mm		

			
1			
No.	106548	Ref. No.	00210A
description	gas injector thread 3/8" WS 17 bore ø 2.6mm		

			
1			
No.	106556	Ref. No.	00217A
description	gas injector thread 3/8" WS 17 bore ø 3.3mm		

			
1			
No.	106549	Ref. No.	00211A
description	gas injector thread 3/8" WS 17 bore ø 2.7mm		

			
1			
No.	106557	Ref. No.	00218A
description	gas injector thread 3/8" WS 17 bore ø 3.5mm		

			
1			
No.	106551	Ref. No.	00212A
description	gas injector thread 3/8" WS 17 bore ø 2.8mm		

			
1			
No.	106558	Ref. No.	00219A 00220A
description	gas injector thread 3/8" WS 17 bore ø 3.6mm		

			
1			
No.	106552	Ref. No.	00213A
description	gas injector thread 3/8" WS 17 bore ø 2.9mm		

			
1			
No.	106559	Ref. No.	00221A
description	gas injector thread 3/8" WS 17 bore ø 3.8mm		

			
1			
No.	106542	Ref. No.	00204A
description	gas injector thread 3/8" WS 17 bore ø 2mm		

			
1			
No.	106553	Ref. No.	00214A
description	gas injector thread 3/8" WS 17 bore ø 3mm		

			
1			
No.	106554	Ref. No.	00215A
description	gas injector thread 3/8" WS 17 bore ø 3.1mm		

			
1			
No.	107208	Ref. No.	00224A
description	gas injector thread 3/8" WS 17 bore ø 4mm		



pilot burner nozzles

pilot burner nozzle AB



1

No.	102740	Ref. No.	01157A
description	pilot burner nozzle LPG code 20 bore \varnothing 0.2mm Qty 1 pcs		

pilot burner nozzles AEM



1

No.	106429	Ref. No.	08285A
description	pilot burner nozzle natural gas bore \varnothing 0.35mm thread M5x0.75 WS 6		

pilot burner nozzles SIT

100 series



1

No.	100245	Ref. No.	01157A 07357A
description	pilot burner nozzle LPG code 20 bore \varnothing 0.2mm Qty 1 pcs thread M8x0.75		



1

No.	102972	Ref. No.	06430A
description	pilot burner nozzle natural gas code 40 bore \varnothing 0.4mm Qty 1 pcs		



1

No.	107171	Ref. No.	7357A
description	pilot burner nozzle SIT natural/liquid gas bore \varnothing 0.25mm Qty 1 pcs		

pilot burner nozzles (other)

SOLYMAC/CAPIC



1

No.	106429	Ref. No.	08285A
description	pilot burner nozzle natural gas bore \varnothing 0.35mm thread M5x0.75 WS 6		

auxiliary gas parts

screw connections

olives



1

No.	101249	Ref. No.	01600A
description	olive for pipe \varnothing 10mm Qty 1 pcs		

accessories for	101249		
No.	101250	Ref. No.	07463A

union nut thread M20x1.5 for pipe \varnothing 10mm

1

No.	101248	Ref. No.	07475A
description	olive for pipe \varnothing 12mm Qty 1 pcs suitable for PEL		

accessories for	101248		
No.	101251	Ref. No.	07462A

union nut thread M20x1.5 for pipe \varnothing 12mm

1

No.	101286	Ref. No.	05377A
description	olive ID \varnothing 6mm Qty 1 pcs		

accessories for	101286		
No.	100909	Ref. No.	07011A

union screw thread M10x1 for pipe \varnothing 6mm Qty 1 pcsunion nut thread M12x1 for pipe \varnothing 6mm

union nuts





1





No.	101250	Ref. No.	07463A
description	union nut thread M20x1.5 for pipe \varnothing 10mm		

accessories for	101250		
No.	101249	Ref. No.	01600A

olive for pipe \varnothing 10mm Qty 1 pcs



			
1			
No.	101251	Ref. No.	07462A
description	union nut thread M20x1.5 for pipe ø 12mm		
accessories for	101251		
	No.	101248	Ref. No. 07475A
	olive for pipe ø 12mm Qty 1 pcs suitable for PEL		

union screws			
			
1			
No.	100909	Ref. No.	07011A
description	union screw thread M10x1 for pipe ø 6mm Qty 1 pcs		
accessories for	100909		
	No.	100898	Ref. No. —
	olive for pipe ø 6mm Qty 1 pcs for pilot burner		
	No.	101286	Ref. No. 05377A
	olive ID ø 6mm Qty 1 pcs		
	No.	101287	Ref. No. —
	olive for pipe ø 6mm Qty 1 pcs		
	No.	101288	Ref. No. —
	olive for pipe ø 6mm L 6mm aluminium Qty 1 pcs ED ø 8.5mm		

pressure switches			
			
1			
No.	541051	Ref. No.	07835A
description	pressure control ø 45mm pressure range adjustable 10-50mbar pressure connection vertical gas technology connection 1/4" pressure connection ø 1/4"mm		

equipment-specific units for coffee grinders

			
1			
No.	345742	Ref. No.	07676A
description	microswitch with lever 250V 16A 1CO connection male faston 6.3mm L 55mm ambient temperature max. 120°C mounting distance 22mm actuating force: 75g lever length 46mm		

for tilting bratt pans

spare parts and accessories			
			
1			
No.	692703	Ref. No.	04256A
description	bush thickness 5mm ID ø 20mm H 20mm ext. ø 30 Qty 1 pcs		

for boiling pans

level glasses			
accessories			
			
1			
No.	541856	Ref. No.	03001A
description	water level tube ø 15mm L 160mm thickness 2.5mm glas		

knobs

universal knobs



No.	110232	Ref. No.	08561A
description	knob switch 4-position t.max.°C°C ø 50mm shaft ø 6x4.6mm shaft flat upper black		

producer-specific knobs

CHARVET



No.	111477	Ref. No.	02021A
description	bezel energy regulator 0-100 t.max.°C°C ø 88mm shaft ømm shaft flat		



No.	111476	Ref. No.	02016A
description	knob zero mark t.max.°C°C ø 46mm shaft ø 6x4.6mm shaft flat upper black		

accessories

fascias



No.	111477	Ref. No.	02021A
description	bezel energy regulator 0-100 t.max.°C°C ø 88mm shaft ømm shaft flat		



locks

edgemount latches

handle latches

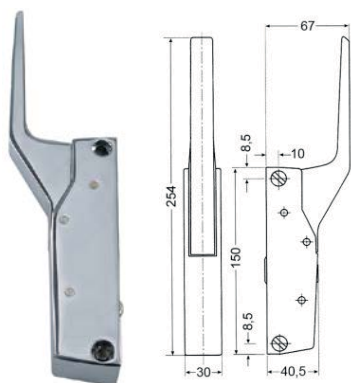
CAFF/FERMOD



No.	700060	Ref. No.	04205A	
description	handle latch L 150mm mounting distance 133mm non lockable heated units G 791			
accessories for	700060			
	No.	700061	Ref. No.	—
	description	door catch L 58mm W 20mm H 35mm mounting distance 42mm chrome-plated brass for headed units		
	No.	700062	Ref. No.	—
	description	handle protection heated units		

miscellaneous



No.	511612	Ref. No.	FERM001
description	closing plate Qty 2 pcs		



fittings for catering equipment



drain taps

brass

drain taps



1

No.	548001	Ref. No.	03917A
description	drain tap 1 1/2" IT O-ring seal kettle connection with union nut A 80mm B1 68mm B2 132mm		
spare parts for	548001		
	No.	505092	Ref. No. —
	O-ring EPDM thickness 5.34mm ID ø 43.82mm Qty 1 pcs		
	No.	540213	Ref. No. —
	handle ID ø 5mm L 117mm		



1

No.	541673	Ref. No.	3917A
description	drain tap 1 1/2" IT with union nut conical seal		
spare parts for	541673		
	No.	540213	Ref. No. —
	handle ID ø 5mm L 117mm		
	No.	540956	Ref. No. —
	gasket for drain tap hose ext. ø 46mm ID ø 38mm H 2mm		
accessories for	541673		
	No.	510404	Ref. No. —
	flat gasket fibre ED ø 44mm ID ø 34mm thickness 2mm Qty 1 pcs		
	No.	890116	Ref. No. —
	fitting grease FERMIT GLISSA tube 60g -20 up to +140°C approval complies with KTW recommendation		
	No.	890118	Ref. No. —
	fitting grease FERMIT GLISSA can 1000g -20 up to +140°C approval complies with KTW recommendation		
	No.	890119	Ref. No. —
	fitting grease FERMIT GLISSA tube 30g -20 up to +140°C approval complies with KTW recommendation		



1

No.	541872	Ref. No.	07358A
description	drain tap ball valve A 68mm B1 33mm B2 85mm thread 1" IT		

gaskets

gaskets for heated units

window seals

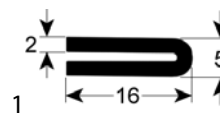

No.	901567	Ref. No.	02286A
description	window gasket profile 1879 L 2350mm suitable for CHARVET Qty 1		

door seals

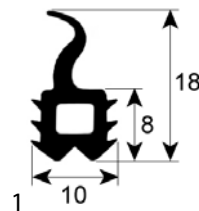

No.	901424	Ref. No.	Join021
description	door seal profile 2711 L 2600mm Qty 1		

O-rings

EPDM

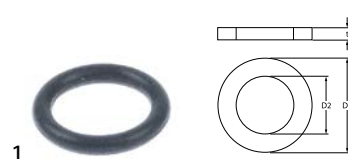

1

No.	501413	Ref. No.	04087A
description	O-ring EPDM thickness 3mm ID ø 14mm Qty 1 pcs		

silicone

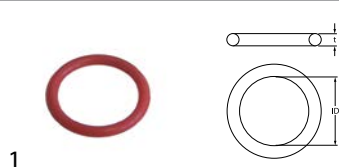

No.	532519	Ref. No.	504952
description	O-ring silicone thickness 5.34mm ID ø 53.34mm Qty 1 pcs		

manometers



No.	541579	Ref. No.	0798A
description	manometer ø 52mm pressure range 0 up to 1bar connection marking 0.5 thread 1/4"		



No.	541062	Ref. No.	07986A
description	manometer ø 63mm pressure range 0 up to 1bar connection marking adjustable kettle thread 1/4"		
spare parts for	541062		
	No.	541130	Ref. No. —
	glass panel ø 58mm thickness 2mm		

dosing pumps

membrane dosing pumps

self-priming

LANG

accessories



No.	101286	Ref. No.	05377A
description	olive ID ø 6mm Qty 1 pcs		

accessories for	101286		
	No.	100909	Ref. No. 07011A
	union screw thread M10x1 for pipe ø 6mm Qty 1 pcs		

	No.	101464	Ref. No. —
	union nut thread M12x1 for pipe ø 6mm		

fastening material

nuts

hexagonal nuts

hexagonal nuts with PG thread



No.	550577	Ref. No.	02407A
description	nut thread PG16 H 3mm WS 26 nickel-plated brass Qty 1 pcs mounting ømm cable ømm		