

Professionall

Solutii profesionale pentru echipamente profesionale



GAS COMPONENTS



ELECTRIC COMPONENTS



WATER TECHNOLOGY



MECHANICAL COMPONENTS



TOOLS

Spare parts suitable for

CEADO



heating elements

quartz heating elements

1 			
GEV No.	420274	Ref. No.	50111
description	quartz heating element 500W 110V L 370mm ø 10mm connection male faston 6.3mm		

switches and momentary switches



rocker/momentary rocker switches

19x13mm			
1 			
GEV No.	347978	Ref. No.	50108 M98
description	rocker switch mounting measurements 19x13mm black 2NO 240V 6A connection male faston 4.8mm ambient temperature max. 125°C protection IP40		
For models:	E37, E37-Elettronico		

30x11mm			
1 			
GEV No.	347350	Ref. No.	50113
description	rocker switch mounting measurements 30x11mm black 1CO 250V 16A I O connection male faston 6.3mm ambient temperature max. 90°C protection IP40		

push/momentary push switches

19x13mm			
1 			
GEV No.	347283	Ref. No.	50171
description	momentary push switch mounting measurements 19x13mm black 1NO 250V 10A connection male faston 2.8mm ambient temperature max. 120°C protection IP40		
For models:	E10ADX-Grigio, E6A-Destro-Grigio, E6TDX-Grigio, E7A-Destro-Grigio, E7T-Destro-Grigio, E8ADX-Grigio, E8TDX-Grigio, E9ADX-Grigio		

ø16mm			
1 			
GEV No.	301310	Ref. No.	50141+50137+50148 90125
description	push switch mounting ø 16mm chrome 1NO 250V 16A connection male faston 6.3mm protection IP40 ambient temperature max. 150°C		
spare parts for	301310		
	GEV No.	347676	Ref. No. 50141
switch 1NO 250V 16A connection male faston 6.3mm			

1 			
GEV No.	301309	Ref. No.	90124
description	push switch mounting ø 16mm chrome 2NO 250V 16A connection male faston 6.3mm protection IP40 ambient temperature max. 150°C		

ø25mm			
1 			
GEV No.	345160 ¹	Ref. No.	50132
description	push switch mounting ø 25mm red 2NO 250V 16A illuminated connection male faston 6.3mm ambient temperature max. 85°C protection IP40		

¹illuminated

miscellaneous			
1 			
GEV No.	347977	Ref. No.	50175
description	momentary push switch mounting ø 12mm black 1NC 250V 16A connection male faston 6.3mm ambient temperature max. 85°C protection IP40		

1 			
GEV No.	347979	Ref. No.	50174 E2054
description	momentary push switch mounting ø 12mm black 1NO 250V 16A connection male faston 6.3mm ambient temperature max. 85°C protection IP40		

1 			
GEV No.	347980	Ref. No.	50151
description	momentary push switch mounting ø 12mm black 1NO 250V 16A connection male faston 6.3mm ambient temperature max. 85°C protection IP40		



toggle switches

M12x0.75



1

GEV No.	346516	Ref. No.	50134
description	toggle switch thread M12x0.75 1NO 250V 15A ON-OFF male faston 6.3mm		



1

GEV No.	346521	Ref. No.	50133
description	toggle switch thread M12x0.75 2CO 250V 15A ON-OFF-MOM male faston with neutral position		

accessories



1

GEV No.	347679	Ref. No.	50143
description	protection cap for toggle switch thread M12x0.75		

microswitches

lever actuated



1

GEV No.	347285	Ref. No.	50327
description	microswitch with cable 250V 16A 1NO connection with cable ambient temperature max. 85°C lever length 36mm		
For models:	E10ADX-Grigio, E6A-Destro-Grigio, E7A-Destro-Grigio, E8ADX-Grigio, E9ADX-Grigio		



1

GEV No.	580078	Ref. No.	50123 83261045
description	microswitch with lever 250V 16A 1CO connection male faston 4.8mm L 68mm ambient temperature max. 125°C mounting distance 22.2mm type 83261 actuating force: 30g		
For models:	E37, E37-Elettronico		



1

GEV No.	347677	Ref. No.	50105
description	microswitch with lever 250V 16A 1CO connection male faston 6.3mm L 33mm ambient temperature max. 85°C mounting distance 22mm type 83263 actuating force: 35g lever length 25mm		

pin-plunger actuated

non-standard



1

GEV No.	347284	Ref. No.	50324
description	microswitch with plunger 250V 5A 1NO connection soldering connection ambient temperature max. 85°C with cable cable length 370mm		
For models:	E10ADX-Grigio, E6A-Destro-Grigio, E7A-Destro-Grigio, E8ADX-Grigio, E9ADX-Grigio		

non-standard



1

GEV No.	347606	Ref. No.	90505
description	microswitch 250V 1NO with cable cable length 350mm		
For models:	E10ADX-Grigio, E6A-Destro-Grigio, E7A-Destro-Grigio, E8ADX-Grigio, E9ADX-Grigio		

system switches (ROLD)



1

GEV No.	347308	Ref. No.	50137
description	element holder mounting ø 16mm arched black ø 15.9mm ED ø 20mm H 23.5mm		





1

GEV No.	347282	Ref. No.	50138
description	push button ø 11.9mm chrome-plated 0-1 shaft L 4mm shaft 3.7x3.7mm		
For models:	E10ADX-Grigio, E10SDX-Grigio, E6A-Destro-Grigio, E6S-Destro-Grigio, E6TDX-Grigio, E7A-Destro-Grigio, E7S-Destro-Grigio, E7T-Destro-Grigio, E8ADX-Grigio, E8SDX-Grigio, E8TDX-Grigio, E9ADX-Grigio, E9SDX-Grigio		



			
1			
GEV No.	347680	Ref. No.	50148
description	push button ø 11.9mm chrome-plated 1-2 shaft L 4mm shaft 3.7x3.7mm		

			
1			
GEV No.	345722	Ref. No.	50178
description	switch 1NO 250V 16A connection male faston 6.3mm		
For models:	E6TDX-Grigio, E7T-Destro-Grigio, E8TDX-Grigio		

			
1			
GEV No.	347676	Ref. No.	50141
description	switch 1NO 250V 16A connection male faston 6.3mm		

			
1			
GEV No.	345720	Ref. No.	50170
description	switch 2NO 250V 16A connection male faston 6.3mm		
For models:	E10ADX-Grigio, E10SDX-Grigio, E6A-Destro-Grigio, E6S-Destro-Grigio, E7A-Destro-Grigio, E7S-Destro-Grigio, E8ADX-Grigio, E8SDX-Grigio, E9ADX-Grigio, E9SDX-Grigio		

			
1			
GEV No.	347678	Ref. No.	50140
description	switch 2NO 250V 16A connection male faston 6.3mm black latching triggering pressure 1500mbar ambient temperature max. 150°C series CM		

timers

mechanical timers

			
1			
GEV No.	350039	Ref. No.	50112 M215M2C41
description	timer M2 2-pole operation time 15min impulse spring 2NO at 250V 16A shaft ø 3.6mm shaft squaremm shaft L 16.5mm mounting distance 29mm mounting thread M4 connection male faston 6.3mm ambient temperature max. 125°C 250V		

relays

power relays

with bracket mounting

			
1			
GEV No.	380702	Ref. No.	50153
description	power relays FINDER 230VAC 16A 3NO connection male faston 6.3mm flange dimensions 36x38x68mm manuf. no. 62.83.8.230.0300 230V		

			
1			
GEV No.	381226	Ref. No.	4346.618.230.0040 + 4304605 50155
description	relay FINDER 230VAC 16A 1CO connection male faston 4.8mm flange manuf. no. 46.61.8.230.0040		

electronics

PCBs

			
1			
GEV No.	403441	Ref. No.	50130
description	PCB espresso machine V90 L 65mm W 46mm suitable for CEADO 50Hz voltage input 230V vottage output 230V 230V H 22mm type 1220001 voltage AC Qty 1 pcs		

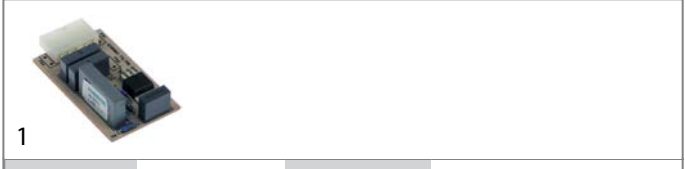

1	GEV No. 403085	Ref. No.	50162
description	PCB for blenders L 65mm W 35.5mm		



1	GEV No. 402430	Ref. No.	50177
description	PCB for coffee grinder 230V 12V		
For models:	E10ADX-Grigio, E6A-Destro-Grigio, E6TDX-Grigio, E7A-Destro-Grigio, E7T-Destro-Grigio, E8ADX-Grigio, E8TDX-Grigio, E9ADX-Grigio		

motors

gear motors

for ice crusher



1	GEV No. 499203	Ref. No.	30107 30107+75501+75508
description	gear motor for ice crusher CIARAMELLA type 624017 220/240V voltage AC 50/60Hz shaft ø 8mm shaft length 33mm mounting distance 34mm with fan wheel		

motors

for bar blender



1	GEV No. 501455	Ref. No.	30103
description	motor for bar blender 220V 450W 50Hz 800rpm thread M6L shaft ø 8mm mounting distance 36mm H 60mm L 165mm W 80mm mounting thread M4 Dragone CEADO		



1	GEV No. 501456	Ref. No.	30108
description	motor for bar blender 230V 1500W 50Hz 28000rpm 1 phase thread M6L shaft ø 8mm mounting distance 55mm H 100mm L 160mm W 90mm CEADO		



1	GEV No. 499202	Ref. No.	90115
description	motor for mixer 230V 50Hz 1 phase shaft ø 10mm shaft length 125mm H 117mm L 70mm W 62mm		

fans

axial fans

import



1	GEV No. 601604 ¹	Ref. No.	12032ASTAD 50193
description	axial fan L 119mm W 119mm H 38mm 230VAC 50/60Hz 17/15W bearing slide bearing manuf. no. AA1282HS-AT connection cable 300mm fan wheel ø 110mm temp.-resist. 70°C input current 0.1A airflow 130m ³ /h 2600rpm		
For models:	E10ADX-Grigio, E10SDX-Grigio, E8ADX-Grigio, E8SDX-Grigio, E8TDX-Grigio, E9ADX-Grigio, E9SDX-Grigio		

¹with slide bearings



pumps

booster pumps II

accessories



1

GEV No.	365015	Ref. No.	50104
description	operating capacitor capacity 10µF 400V tolerance 5%Hz ambient temperature max. -25 to +85°C ø 35.5mm L 59mm M8 plastic connection male faston 6.3mm protection		
For models:	E6A-Destro-Grigio, E6S-Destro-Grigio, E7A-Destro-Grigio, E7S-Destro-Grigio, E7T-Destro-Grigio		

condensators & interference suppression filters

operating capacitors

plastic



1

GEV No.	365015	Ref. No.	50104
description	operating capacitor capacity 10µF 400V tolerance 5%Hz ambient temperature max. -25 to +85°C ø 35.5mm L 59mm M8 plastic connection male faston 6.3mm protection		
For models:	E6A-Destro-Grigio, E6S-Destro-Grigio, E7A-Destro-Grigio, E7S-Destro-Grigio, E7T-Destro-Grigio		



1

GEV No.	365021	Ref. No.	50173
description	operating capacitor capacity 16µF 425V tolerance 5% 50/60Hz ambient temperature max. -25 to +85°C ø 35mm L 73mm single M8 plastic connection male faston 6.3mm 416.10.99 protection		
For models:	E10ADX-Grigio, E10SDX-Grigio, E8ADX-Grigio, E8SDX-Grigio, E8TDX-Grigio, E9ADX-Grigio, E9SDX-Grigio		

equipment-specific units

for bar blender

blenders

jar components

jars

complete



1

GEV No.	696347	Ref. No.	90105
description	blender jar plastic 1500ml with blade		



1

GEV No.	696437	Ref. No.	90106
description	blender jar plastic 1500ml with mixer disc		

gaskets



1

GEV No.	651007	Ref. No.	75503
----------------	--------	-----------------	-------

description	gasket ED \varnothing 75mm ID \varnothing 55mm thickness 3mm Qty 1 pcs		
--------------------	--	--	--

holders



1

GEV No.	651052	Ref. No.	70101
----------------	--------	-----------------	-------

description	bracket for jar \varnothing 87mm nominal- \varnothing 60mm plastic		
--------------------	--	--	--

blades

blades with adaptor (complete)



1

GEV No.	651054	Ref. No.	90134
----------------	--------	-----------------	-------

description	slicing unit complete bar blender \varnothing 70mm SS		
--------------------	---	--	--



1

GEV No.	696501	Ref. No.	90101
----------------	--------	-----------------	-------

description	slicing unit complete for blenders \varnothing 73mm		
--------------------	---	--	--

mixer discs (complete)



1

GEV No.	696542	Ref. No.	90102
----------------	--------	-----------------	-------

description	mixer disc complete \varnothing 73mm hole \varnothing 6mm		
--------------------	---	--	--

actuators

group 1



1

GEV No.	651041	Ref. No.	45107
----------------	--------	-----------------	-------

description	mixer coupling \varnothing 22mm H 13mm IT M6L teeth 4 stainless steel		
--------------------	---	--	--

group 2



1

GEV No.	651042	Ref. No.	70103
----------------	--------	-----------------	-------

description	mixer coupling \varnothing 32.5mm H 12mm teeth 4 rubber		
--------------------	---	--	--

mixers

miscellaneous



1

GEV No.	698344	Ref. No.	70124
----------------	--------	-----------------	-------

description	bumper for mixer L 63mm W 30mm plastic ID \varnothing 25mm		
--------------------	--	--	--



1

GEV No.	698342	Ref. No.	40110
----------------	--------	-----------------	-------

description	distance washers for mixer L 20mm ID \varnothing 8mm ED \varnothing 10mm		
--------------------	--	--	--



1

GEV No.	698343	Ref. No.	75107
----------------	--------	-----------------	-------

description	threaded shaft for mixer L 45mm nylon ED \varnothing 7.5mm		
--------------------	--	--	--



for juicers/centrifuges

centrifuge baskets

grating discs

 <p>1</p>			
GEV No.	696499	Ref. No.	20188
description	grating disc for juicer ø 120mm seat ø 14x12mm		

plungers

 <p>1</p>			
GEV No.	650292	Ref. No.	40213
description	plunger ø 76mm L 177mm total length 200mm		

for ice crusher

motors

 <p>1</p>			
GEV No.	499203	Ref. No.	30107 30107+75501+75508
description	gear motor for ice crusher CIARAMELLA type 624017 220/240V voltage AC 50/60Hz shaft ø 8mm shaft length 33mm mounting distance 34mm with fan wheel		

for coffee grinders

grinding burrs

grinding burrs straight

standard

 <p>1</p>			
GEV No.	525524	Ref. No.	40185 90302
description	grinding burrs pair turn direction right D1 ø 64mm ID ø 38mm H 9mm tooth spacing 3mm hole ø 5.5mm bore ø 9mm mounting ø 49 straight suitable for CEADO E6		
For models:	E6A-Destro-Grigio, E6S-Destro-Grigio, E6TDX-Grigio		

 <p>1</p>			
GEV No.	525525	Ref. No.	40168
description	grinding burrs pair turn direction right D1 ø 64mm ID ø 38mm H 9mm tooth spacing 3mm hole ø 5.5mm bore ø 9mm mounting ø 49 straight suitable for CEADO E7		
For models:	E37, E37-Electronico, E7A-Destro-Grigio, E7S-Destro-Grigio, E7T-Destro-Grigio		

 <p>1</p>			
GEV No.	525526	Ref. No.	40180
description	grinding burrs pair turn direction right D1 ø 82.5mm ID ø 49.2mm H 9.5mm tooth spacing 3mm hole ø 6mm bore ø 10.2mm mounting ø 65.5 suitable for CEADO E8		
For models:	E10ADX-Grigio, E10SDX-Grigio, E8ADX-Grigio, E8SDX-Grigio, E8TDX-Grigio, E9ADX-Grigio, E9SDX-Grigio		

screws

 <p>1</p>			
GEV No.	526921	Ref. No.	45315
description	cylinder head bolt thread M4 thread L 10mm head ø 7mm zinc-coated steel Qty 1 pcs intake slotted head thickness 2.5mm		

1 

GEV No.	526922	Ref. No.	45316
description	flat-headed bolt thread M5 thread L 10mm steel Qty 1 pcs intake slotted head ø 8mm head thickness 3mm		

dosing containers

dosing container lids



1

GEV No.	525517	Ref. No.	70146
description	lid for coffee beans container ø 200mm		
For models:	E10ADX-Grigio, E10SDX-Grigio, E37, E37-Elettronico, E6A-Destro-Grigio, E6S-Destro-Grigio, E6TDX-Grigio, E7A-Destro-Grigio, E7S-Destro-Grigio, E7T-Destro-Grigio, E8ADX-Grigio, E8SDX-Grigio, E8TDX-Grigio, E9ADX-Grigio, E9SDX-Grigio		



1

GEV No.	525519	Ref. No.	70141
description	lid for dosing container ø 120mm		
For models:	E10ADX-Grigio, E10SDX-Grigio, E6A-Destro-Grigio, E6S-Destro-Grigio, E6TDX-Grigio, E7A-Destro-Grigio, E7S-Destro-Grigio, E7T-Destro-Grigio, E8ADX-Grigio, E8SDX-Grigio, E8TDX-Grigio, E9ADX-Grigio, E9SDX-Grigio		

springs

group 1



1

GEV No.	525523	Ref. No.	45507
description	torsion spring ø 28mm wire gauge ø 2mm		
For models:	E10ADX-Grigio, E10SDX-Grigio, E6A-Destro-Grigio, E6S-Destro-Grigio, E6TDX-Grigio, E7A-Destro-Grigio, E7S-Destro-Grigio, E7T-Destro-Grigio, E8ADX-Grigio, E8SDX-Grigio, E8TDX-Grigio, E9ADX-Grigio, E9SDX-Grigio		

glass cylinders



1

GEV No.	525518	Ref. No.	70142
description	cylinder for dosing unit ø 118mm H 60mm plexiglas		
For models:	E10ADX-Grigio, E10SDX-Grigio, E6A-Destro-Grigio, E6S-Destro-Grigio, E6TDX-Grigio, E7A-Destro-Grigio, E7S-Destro-Grigio, E7T-Destro-Grigio, E8ADX-Grigio, E8SDX-Grigio, E8TDX-Grigio, E9ADX-Grigio, E9SDX-Grigio		
accessories for	525518		
	GEV No.	525519	Ref. No.
			70141
	 lid for dosing container ø 120mm		

coffee presses

coffee presses



1

GEV No.	525520	Ref. No.	10361
description	coffee press ø 53mm H 16mm aluminium		
For models:	E10ADX-Grigio, E10SDX-Grigio, E6A-Destro-Grigio, E6S-Destro-Grigio, E6TDX-Grigio, E7A-Destro-Grigio, E7S-Destro-Grigio, E7T-Destro-Grigio, E8ADX-Grigio, E8SDX-Grigio, E8TDX-Grigio, E9ADX-Grigio, E9SDX-Grigio		



1

GEV No.	525521	Ref. No.	10362
description	coffee press ø 57mm H 16mm aluminium		
For models:	E10ADX-Grigio, E10SDX-Grigio, E6A-Destro-Grigio, E6S-Destro-Grigio, E6TDX-Grigio, E7A-Destro-Grigio, E7S-Destro-Grigio, E7T-Destro-Grigio, E8ADX-Grigio, E8SDX-Grigio, E8TDX-Grigio, E9ADX-Grigio, E9SDX-Grigio		





coffee beans containers

coffee beans containers



1

GEV No.	525516	Ref. No.	70147
description	coffee beans container ø 200mm H 267mm seat ø 57mm		
For models:	E10ADX-Grigio, E10SDX-Grigio, E37, E37-Elettronico, E6A-Destro-Grigio, E6S-Destro-Grigio, E6TDX-Grigio, E7A-Destro-Grigio, E7S-Destro-Grigio, E7T-Destro-Grigio, E8ADX-Grigio, E8SDX-Grigio, E8TDX-Grigio, E9ADX-Grigio, E9SDX-Grigio		
accessories for	525516		
	GEV No.	525517	Ref. No. 70146
	lid for coffee beans container ø 200mm		
	GEV No.	525522	Ref. No. 70145
	catch for coffee beans container L 122mm W 50mm thickness 6mm plastic		

locks



1

GEV No.	525522	Ref. No.	70145
description	catch for coffee beans container L 122mm W 50mm thickness 6mm plastic		
For models:	E10ADX-Grigio, E10SDX-Grigio, E37, E37-Elettronico, E6A-Destro-Grigio, E6S-Destro-Grigio, E6TDX-Grigio, E7A-Destro-Grigio, E7S-Destro-Grigio, E7T-Destro-Grigio, E8ADX-Grigio, E8SDX-Grigio, E8TDX-Grigio, E9ADX-Grigio, E9SDX-Grigio		

gaskets

sealing washers

silicone gaskets



1

GEV No.	651007	Ref. No.	75503
description	gasket ED ø 75mm ID ø 55mm thickness 3mm Qty 1 pcs		

shaft gaskets

v-rings



1

GEV No.	698360	Ref. No.	75508
description	V-ring for shaft ø 14mm ID ø 12.5mm ED ø 18.5mm thickness 5.5mm		

shaft gaskets



1

GEV No.	698359	Ref. No.	75501
description	shaft sealing ID ø 15mm ED ø 24mm thickness 7mm		

springs

torsion springs



1

GEV No.	525523	Ref. No.	45507
description	torsion spring ø 28mm wire gauge ø 2mm		
For models:	E10ADX-Grigio, E10SDX-Grigio, E6A-Destro-Grigio, E6S-Destro-Grigio, E6TDX-Grigio, E7A-Destro-Grigio, E7S-Destro-Grigio, E7T-Destro-Grigio, E8ADX-Grigio, E8SDX-Grigio, E8TDX-Grigio, E9ADX-Grigio, E9SDX-Grigio		

fastening material

screws

flat-headed bolts



1

GEV No.	526922	Ref. No.	45316
description	flat-headed bolt thread M5 thread L 10mm steel Qty 1 pcs intake slotted head ø 8mm head thickness 3mm		



cylinder head bolts

miscellaneous



1

GEV No.	526921	Ref. No.	45315
description	cylinder head bolt thread M4 thread L 10mm head ø 7mm zinc-coated steel Qty 1 pcs intake slotted head thickness 2.5mm		