

# Professionall

Solutii profesionale pentru echipamente profesionale



**GAS COMPONENTS**



**ELECTRIC COMPONENTS**



**WATER TECHNOLOGY**



**MECHANICAL COMPONENTS**



**TOOLS**

Spare parts suitable for

# BRICE ITALIA



## thermostats

### refrigeration thermostats

#### RANCO

##### K22 series

RANCO



<b>No.</b>	390524	<b>Ref. No.</b>	926081 RF50B893
<b>description</b>	thermostat RANCO type K22L1082 probe $\varnothing$ mm probe Lmm capillary pipe 2000mm temperature range -22 up to -3°C		

RANCO



<b>No.</b>	390296	<b>Ref. No.</b>	926077 RF000618
<b>description</b>	thermostat RANCO type K22-L2069 probe $\varnothing$ 2mm probe L 10mm capillary pipe 1500mm		

##### K50 series

RANCO



<b>No.</b>	390270	<b>Ref. No.</b>	RF000610
<b>description</b>	thermostat RANCO type K50L3019 probe $\varnothing$ mm probe Lmm capillary pipe 1250mm temperature range +1 up to +7.5°C		

RANCO



<b>No.</b>	390286	<b>Ref. No.</b>	926080 RF50B892
<b>description</b>	thermostat RANCO type K50L3383 probe $\varnothing$ mm probe Lmm capillary pipe 1500mm temperature range +1 up to +3°C		

### miscellaneous producers



<b>No.</b>	390956	<b>Ref. No.</b>	926136
<b>description</b>	thermostat temperature range°C probe $\varnothing$ 2mm probe L 10mm capillary pipe 1500mm type		

## switches and momentary switches

### rocker/momentary rocker switches

#### 30x22mm

##### labelled



<b>No.</b>	346870	<b>Ref. No.</b>	RI000751
<b>description</b>	rocker switch mounting measurements 30x22mm blue 2NO 250V 16A illuminated 0-1 connection male faston 6.3mm ambient temperature max. 85°C protection IP65 with cover cap		

<b>accessories for</b>	346870			
	<b>No.</b>	301036	<b>Ref. No.</b>	—
	protective cover internal size 30x22mm for rocker switch mounting measurementsmm			



<b>No.</b>	300125	<b>Ref. No.</b>	926041
<b>description</b>	rocker switch mounting measurements 30x22mm green 2NO 230V 16A 0-1 connection male faston 6.3mm ambient temperature max. 125/55°C protection IP65 with cover cap		

<b>accessories for</b>	300125			
	<b>No.</b>	301036	<b>Ref. No.</b>	—
	protective cover internal size 30x22mm for rocker switch mounting measurementsmm			

### push/momentary push switches

#### 19x13mm



<b>No.</b>	346871 <sup>1</sup>	<b>Ref. No.</b>	RI00B281
<b>description</b>	push switch mounting measurements 19x13mm green 2NO 250V 16A illuminated connection male faston 4.8mm ambient temperature max. 105/55°C protection IP40		

<b>accessories for</b>	346871			
	<b>No.</b>	346541	<b>Ref. No.</b>	—
	protective cover for rocker switch external size 23.4x17.4mm internal size 19x13mm H 9.5mm mounting measurementsmm			



ø25mm



1

<b>No.</b>	345011	<b>Ref. No.</b>	926113 RI00C883
<b>description</b>	push switch mounting ø 25mm green 2NO 250V 16A illuminated connection male faston 6.3mm ambient temperature max. 85°C protection IP65		
<b>accessories for</b>	345011		
	<b>No.</b>	345039	<b>Ref. No.</b> —
	protective cover round ED ø 33mm external size 23mm internal size 21mm H 12mm clear mounting ø 25mm		

## microswitches

## lever actuated



1

<b>No.</b>	346872	<b>Ref. No.</b>	RI000800
<b>description</b>	microswitch with lever 250V 0.1A 1CO connection male faston 6.3mm L 50mm ambient temperature max. 85°C mounting distance 22mm type D41X actuating force: 6g lever length 36mm		



1

<b>No.</b>	347997	<b>Ref. No.</b>	926054
<b>description</b>	microswitch with lever 250V 3A 1NO connection male faston 6.3mm L 77mm ambient temperature max. 125°C mounting distance 24mm type VRSRB1AA1 actuating force: 160g		

## roller-lever actuated

## with mounting components



1

<b>No.</b>	347568	<b>Ref. No.</b>	926055 AS928054 RI00A240
<b>description</b>	microswitch with handle with a switch 250V 10A 1CO connection male faston 6.3mm L 25mm ambient temperature max. 85°C mounting distance 24mm type VR actuating force: 50g lever length 31mm		



1

<b>No.</b>	345370	<b>Ref. No.</b>	RH003800
<b>description</b>	microswitch with handle with a switch 250V 16A 1CO connection male faston 6.3mm L 27mm ambient temperature max. 125°C mounting distance 24mm actuating force: 45g lever length 26.5mm		

## float switches



1

<b>No.</b>	345372	<b>Ref. No.</b>	RH000830 RI00A241
<b>description</b>	float switch 1CO ø 15mm L 104mm 250V 6A male faston 6.3mm cable lengthmm		



1

<b>No.</b>	345371	<b>Ref. No.</b>	RH00A310
<b>description</b>	float switch with plunger 250V 16A 1CO male faston 6.3mm L 60mm ambient temperature max. 125°C mounting distance 22mm type EF83161.5 actuating force: 20g blue/black		

## floats



1

<b>No.</b>	695044	<b>Ref. No.</b>	RH000679
<b>description</b>	float		



timers

programme timers

1



<b>No.</b>	360524	<b>Ref. No.</b>	926070 RF50B869	
<b>description</b>	timer CDC 11904 engines 1 chambers 4 operation time 12min 230V shaft ømm shaft Lmm manuf. no. 11904F1 / BDR000.0000 motor type M48R ATS			
<b>spare parts for</b>	360524			
	<b>No.</b>	360118	<b>Ref. No.</b>	—
	 motor CDC pinion ø 4.9mm teeth 10 230V voltage AC 50/60Hz turn direction right motor ø 47mm H 19.3mm motor type M48R ATS for timer cable length 260mm 1.9/2.5W			

1



<b>No.</b>	360550	<b>Ref. No.</b>	926071	
<b>description</b>	timer CDC 11904 engines 1 chambers 4 operation time 15min 230V 50/60Hz shaft ømm shaft Lmm manuf. no. 11904F1 / BER000.0000			
<b>spare parts for</b>	360550			
	<b>No.</b>	360118	<b>Ref. No.</b>	—
	 motor CDC pinion ø 4.9mm teeth 10 230V voltage AC 50/60Hz turn direction right motor ø 47mm H 19.3mm motor type M48R ATS for timer cable length 260mm 1.9/2.5W			

1



<b>No.</b>	360609	<b>Ref. No.</b>	926203 RF50C111
<b>description</b>	timer CDC 11904 engines 1 chambers 4 operation time 15min 230V 60Hz shaft ømm shaft Lmm manuf. no. 11904F1BEY000.0010		

relays

power relays

with bracket mounting

1



<b>No.</b>	380626	<b>Ref. No.</b>	926072
<b>description</b>	power relays FINDER 230VAC 10A 2CO connection male faston 4.8mm bracket mounting manuf. no. 62.62.8.230.0000		

1



<b>No.</b>	380312	<b>Ref. No.</b>	RI000761
<b>description</b>	power relays FINDER 230VAC 10A 3CO connection male faston 4.8mm bracket mounting dimensions 52x32.2x36.5mm manuf. no. 60.63.8.230.0000		

relay sockets

1

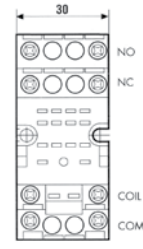
<b>No.</b>	380378	<b>Ref. No.</b>	RF000556	
<b>description</b>	relay socket 2-pole 55/85 dimensions 70.5x30x27mm 250V voltage AC 10A FINDER manuf. no. 94.72			
<b>accessories for</b>	380378			
	<b>No.</b>	380804	<b>Ref. No.</b>	—
	 support bracket			



## time relays

## time relays





1

<b>No.</b>	380770	<b>Ref. No.</b>	RF000555
<b>description</b>	time relay connection plug-in connection round 8-pole		



1

<b>No.</b>	380329	<b>Ref. No.</b>	RF000555	
<b>description</b>	time relay FIBER 85.02.8.240 time range 0.05s - 100h 230-240VAC 10A mounting measurements 20.6x27.7mm 2CO connection 2.0			
<b>accessories for</b>	380329			
	<b>No.</b>	380378	<b>Ref. No.</b>	RF000556
	relay socket 2-pole 55/85 dimensions 70.5x30x27mm 250V voltage AC 10A FINDER manuf. no. 94.72			
	<b>No.</b>	380803	<b>Ref. No.</b>	—
	relay socket 2-pole dimensions 76.2x27x86.1mm 250V voltage AC 10A FINDER manuf. no. 94.92.3			

## electronics

## PCBs



1

<b>No.</b>	401606	<b>Ref. No.</b>	RI00A031
<b>description</b>	display		

## solenoid valves

## solenoid valves (water)

## TP



1











<b>No.</b>	370019	<b>Ref. No.</b>	RF000625	
<b>description</b>	solenoid valve double angled 230VAC inlet 3/4" outlet 11.5mm DN10 TP plastic			
<b>spare parts for</b>	370019			
	<b>No.</b>	371013	<b>Ref. No.</b>	—
	solenoid coil TP 230VAC 50/60Hz			
<b>accessories for</b>	370019			
	<b>No.</b>	371220	<b>Ref. No.</b>	—
	reducer TP flow rate 3l/min red tolerance ±15%			
	<b>No.</b>	371221	<b>Ref. No.</b>	—
	reducer TP flow rate 5.5l/min yellow tolerance ±15%			
	<b>No.</b>	371222	<b>Ref. No.</b>	—
	reducer TP flow rate 6l/min grey tolerance ±15%			
	<b>No.</b>	371223	<b>Ref. No.</b>	—
	reducer TP flow rate 10l/min white tolerance ±15%			
	<b>No.</b>	371224	<b>Ref. No.</b>	—
	reducer TP flow rate 12l/min bronze tolerance ±15%			
	<b>No.</b>	371225	<b>Ref. No.</b>	—
	reducer TP flow rate 16l/min light brown tolerance ±15%			
	<b>No.</b>	371226	<b>Ref. No.</b>	—
	reducer TP flow rate 20l/min red tolerance ±15%			
	<b>No.</b>	371230	<b>Ref. No.</b>	—
	reducer TP flow rate 0.25l/min red tolerance ±25%			
	<b>No.</b>	371231	<b>Ref. No.</b>	—
	reducer TP flow rate 0.35l/min violet tolerance ±25%			
	<b>No.</b>	371232	<b>Ref. No.</b>	—
	reducer TP flow rate 0.5l/min orange tolerance ±25%			
	<b>No.</b>	371233	<b>Ref. No.</b>	—
	reducer TP flow rate 0.8l/min white tolerance ±25%			
	<b>No.</b>	371234	<b>Ref. No.</b>	—
	reducer TP flow rate 1l/min light blue tolerance ±25%			
	<b>No.</b>	371235	<b>Ref. No.</b>	—
	reducer TP flow rate 1.2l/min brown tolerance ±25%			

Table continues overleaf





accessories for		370019		
No.	Ref. No.	No.	Ref. No.	—
	371236			
reducer TP flow rate 1.5l/min light brown tolerance ±25%				
	371237			
reducer TP flow rate 2.5l/min yellow tolerance ±25%				
	371238			
reducer TP flow rate 3.4l/min dark green tolerance ±25%				
	371239			
reducer TP flow rate 5l/min black tolerance ±25%				
	371240			
reducer TP flow rate 8l/min blue tolerance ±20%				

			
1			
No.	Ref. No.	926117	
<b>description</b> solenoid valve single angled 220-240VAC inlet 3/4" outlet 11.5mm input 3l/min DN10 TP flow regulating valve inlet light blue			

			
1			
No.	Ref. No.	926141	
<b>description</b> solenoid valve single angled 230VAC inlet 3/4" outlet 11.5mm input 2.5l/min outputl/min DN10 t.max. 90°C TP plastic flow regulating valve inlet yellow			

solenoid valves with reducers			
			
1			
No.	Ref. No.	926125	
<b>description</b> solenoid valve double angled 230VAC inlet 3/4 output 1.5/2.5l/min TP outlet 11.5mm output A yellowl/min output B brownl/min			

			
1			
No.	Ref. No.	926093	
<b>description</b> solenoid valve single angled 230VAC inlet 3/4" outlet 11.5mm inputl/min output 0.8l/min DN10 t.max. 90°C TP plastic			

			
1			
No.	Ref. No.	926137	
<b>description</b> solenoid valve double angled 230VAC inlet 3/4" inputl/min output 0.8/0.8l/min DN10 t.max. 90°C TP plastic outlet 11.5mm output A 0.8l/min output B 0.8l/min flow regulating valve outlet A white flow regulating valve outlet B white			

			
1			
No.	Ref. No.	926132	
<b>description</b> solenoid valve single angled 230VAC inlet 3/4" outlet 11.5mm inputl/min output 1.2l/min DN10 t.max. 90°C TP plastic flow regulating valve outlet dark brown			

			
1			
No.	Ref. No.	926032	
<b>description</b> solenoid valve double angled 230VAC inlet 3/4" inputl/min output 1.5/2.5l/min DN10 t.max. 90°C TP plastic outlet 11.5mm flow regulating valve outlet A light brown flow regulating valve outlet B yellow			

			
1			
No.	Ref. No.	926034 RF000624	
<b>description</b> solenoid valve single angled 230VAC inlet 3/4" outlet 11.5mm output 2.5l/min t.max. 90°C TP plastic flow regulating valve outlet yellow			



solenoid valves (refrigeration)

CASTEL valves



<b>No.</b>	370567	<b>Ref. No.</b>	RF000532
<b>description</b>	solenoid valve angled type 1018/M617A6 230V p max 35bar connection 6mm soldering connection -35 up to 110°C CASTEL 50/60Hz cable length 600mm		

valve bodies STANDARD series

suitable for refrigerants R22, R134a, R404A, R407C, R410A, R507



<b>No.</b>	370151	<b>Ref. No.</b>	920026 BR20410 RF000557
------------	--------	-----------------	-------------------------------

**description** solenoid valve body NC type 1028/2 S p max 45bar connection 1/4" soldering connection DN 2.2mm -35 up to +105°C L 125mm refrigeration straight CASTEL

<b>accessories for</b>	370151			
	<b>No.</b>	371084	<b>Ref. No.</b>	—
	solenoid coil CASTEL 230VAC 8VA 50/60Hz connection cable 1000mm type CM2			
	<b>No.</b>	371090	<b>Ref. No.</b>	—
	power socket plug type DIN 43650A screw			
	<b>No.</b>	371301	<b>Ref. No.</b>	—
	solenoid coil CASTEL 110VAC 8VA 50/60Hz seat ø 11.5mm connection DIN 43650A type HF2			
	<b>No.</b>	371314	<b>Ref. No.</b>	—
	solenoid coil CASTEL 240VAC 8VA 50/60Hz seat ø 11.5mm			
	<b>No.</b>	371321	<b>Ref. No.</b>	—
	solenoid coil CASTEL 12/24VAC 50/60Hz seat ø 11.5mm connection DIN 43650A type HF2			

spare parts and accessories



<b>No.</b>	371041	<b>Ref. No.</b>	926092 BR23091
------------	--------	-----------------	-------------------

**description** solenoid coil CASTEL 240VAC 8VA 50/60Hz seat ø 11.5mm connection DIN 43650A type HM2

**accessories for** 371041

	<b>No.</b>	371090	<b>Ref. No.</b>	—
--	------------	--------	-----------------	---

power socket plug type DIN 43650A screw

	<b>No.</b>	371092	<b>Ref. No.</b>	—
--	------------	--------	-----------------	---

power socket plug type DIN large cable length 1000mm

CEME valves

with pipe clamp

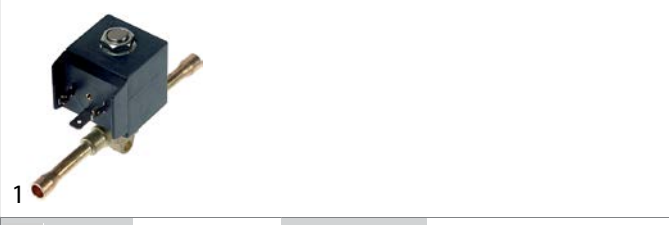

<b>No.</b>	370408	<b>Ref. No.</b>	RF00B770
------------	--------	-----------------	----------

**description** solenoid valve straight CEME type 6807 230V pressure range 0.1-25bar DN2.5 connection 6mm soldering connection -45 up to +125°C refrigeration

various valves

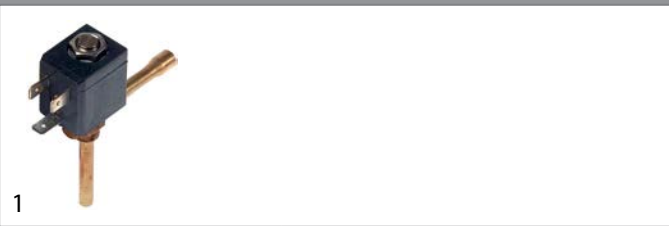

<b>No.</b>	370406	<b>Ref. No.</b>	RF000531 RF000532
------------	--------	-----------------	----------------------

**description** solenoid valve angled type 5925 p max 25bar DN1.5 connection 6mm soldering connection -45 up to +125°C CEME refrigeration 230V

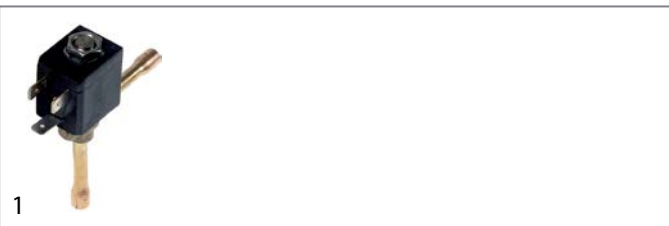

<b>No.</b>	370407	<b>Ref. No.</b>	RF000532
------------	--------	-----------------	----------

**description** solenoid valve angled type 5925 pressure range 0.1-25bar DN2.0 connection 6mm soldering connection -45 up to +125°C CEME refrigeration 230V



			
1			
<b>No.</b>	370666	<b>Ref. No.</b>	926082 926091+920025
<b>description</b>	solenoid valve angled type NEV-202DXF 2251 J 230VAC connection 6mm soldering connection 230V		

## pressure switches

for refrigeration

SAGI NO MIYA			
			
1			
<b>No.</b>	541479	<b>Ref. No.</b>	926069
<b>description</b>	pressure control HD reset automatic refrigeration type HTB-X114 connection 2.4mm		

			
1			
<b>No.</b>	541120	<b>Ref. No.</b>	RF000621
<b>description</b>	pressure control HD reset automatic refrigeration type HTB-X3028 connection male faston 6.3mm switch-on pressure 17bar		

## miscellaneous

			
1			
<b>No.</b>	542331	<b>Ref. No.</b>	926115
<b>description</b>	pressure control -55 up to +130°C pressure connection 6mm pressure range 16.6/17.8bar		

## compressors

ACC/ZEL

R404a/R507

HMBP monophase

High/Medium evaporation temperature above -20/-15 °C

			
1			
<b>No.</b>	605020	<b>Ref. No.</b>	RB00A795
<b>description</b>	compressor coolant R404a/R507 type ML40TB 220-240V 50Hz HMBP fully hermetic 10kg 1/6HP cylinder capacity 4.04cm <sup>3</sup> CSIR H 175.5mmW 168W 218W 276W 342W 416W 499W 589W 688W test method ASHRAE		

			
1			
<b>No.</b>	605074	<b>Ref. No.</b>	RB00B369
<b>description</b>	compressor coolant R404a/R507 type ML60TG 220-240V 50Hz HMBP fully hermetic 10kg 1/4HP cylinder capacity 5.7cm <sup>3</sup> CSIR H 191.1mmW 218W 286W 365W 457W 562W 678W 807W 947W test method ASHRAE		

			
1			
<b>No.</b>	605014	<b>Ref. No.</b>	RB00A797
<b>description</b>	compressor coolant R404a/R507 type ML80TB 220-240V 50Hz HMBP fully hermetic 11.4kg 3/8HP cylinder capacity 7.57cm <sup>3</sup> CSIR H 175.5mmW 261W 346W 446W 561W 691W 835W 993W 1167W test method ASHRAE ambient temperature max. 43°C		



EMBRACO / ASPERA

R404a/R507

HMBP monophase

High/Medium evaporation temperature above -20/-15 °C



1	<b>No.</b>	605139	<b>Ref. No.</b>	926023
<b>description</b>	compressor coolant R404a/R507 type EMT6165GK 220-240V 50Hz HMBP 7.92kg 1/4HP cylinder capacity 5.19cm <sup>3</sup> CSIR H 180mmWW 315W 384W 477W 570W 689W 808W test method ASHRAE			



1	<b>No.</b>	605030	<b>Ref. No.</b>	RB00B162
<b>description</b>	compressor coolant R404a/R507 type NJ9226GK 220-240V 50Hz HMBP fully hermetic 20.8kg 1HP cylinder capacity 21.7cm <sup>3</sup> CSR H 265mmW 1363W 1764W 2249W 2819W 3472W 4210W 5032W test method ASHRAE			



1	<b>No.</b>	605028	<b>Ref. No.</b>	RB00A798
<b>description</b>	compressor coolant R404a/R507 type ML90TB 220-240V 50Hz HMBP fully hermetic 11.6kg 3/8HP cylinder capacity 8.85cm <sup>3</sup> CSIR H 175.5mmW 323W 418W 532W 666W 819W 990W 1181W 1391W test method ASHRAE ambient temperature max. 43°C			

CUBIGEL

R404a/R507

HMBP monophase

High/Medium evaporation temperature above -20/-15 °C



1	<b>No.</b>	605013	<b>Ref. No.</b>	RB00A796 RB00B369
<b>description</b>	compressor coolant R404a/R507 type ML60TB 220-240V 50Hz HMBP fully hermetic 10.1kg 1/4HP power input 647W cylinder capacity 5.68cm <sup>3</sup> CSIR H 175.5mmW 244W 319W 407W 511W 628W 760W 906W 1067W test method ASHRAE			



1	<b>No.</b>	605029	<b>Ref. No.</b>	RB00B149
<b>description</b>	compressor coolant R404a/R507 type MP12RB 220-240V 50Hz HMBP fully hermetic 13.5kg 1/2HP cylinder capacity 12cm <sup>3</sup> CSR H 203.6mmW 561W 734W 933W 1157W 1407W 1681W 1982WW test method ASHRAE ambient temperature max. 43°C			



L'UNITE HERMETIQUE / TECUMSEH

R404A

HMBP monophase

High/Medium evaporation temperature above -20/-15 °C



1	No.	605025	Ref. No.	RB00B620	
	description	compressor coolant R404A type AE4430Z-FZ 220-240V 50Hz HMBP fully hermetic 10.2kg 1/4HP power input 427W cylinder capacity 5.7cm <sup>3</sup> CSIR H 186mmWW 258W 346W 441W 550W 682W 794W test method EN 12900 908W			
	spare parts for	605025			
		No.	380061	Ref. No.	—
		start relay MTRP0027-31 120/240V voltage AC 8A 1NO			



1	No.	605021	Ref. No.	RB00B133
	description	compressor coolant R404A type AEZ4425Z 220-240V 50Hz HMBP fully hermetic 9.8kg 1/5HP cylinder capacity 4.5cm <sup>3</sup> CSIR H 186mmWW 198W 263W 341W 432W 537W 629W test method EN 12900 723W		



1	No.	605022	Ref. No.	RB000440
	description	compressor coolant R404A type AEZ4440Z 230V 50Hz HMBP fully hermetic 21kg cylinder capacity 7.55cm <sup>3</sup> CSIR H 292mm 415W 517W 637W 772W 919W 1074W test method EN 12900 1234W		

fans

refrigeration fans

refrigeration motors universal

ebm-papst

miscellaneous



1	No.	601405	Ref. No.	RC000451 RD00B934	
	description	fan motor M4Q045-CA01-19 7W 230V 50Hz W 83mm			
	spare parts for	601405			
		No.	601413	Ref. No.	—
		fixing plate suitable for fanwheel ED ø 32mm shaft ø 7 mounting distance 26mm			

ELCO

N series - multi fit



1	No.	601427	Ref. No.	RC000452	
	description	fan motor ELCO 10W 230V 50/60Hz bearing slide bearing L1 49mm L2 59mm L3 86.5mm W 83mm connection cable 500mm 1300/1550rpm 5 mounting options VNT10-20/028			
	spare parts for	601427			
		No.	560140	Ref. No.	—
		hexagonal nut thread M4 H 4.8mm SS WS 7 Qty 20 pcs DIN/ISO DIN 985 self-locking			
		No.	560332	Ref. No.	—
		plain washer ID ø 4.3mm ED ø 9mm thickness 0.8mm SS Qty 1 pcs			
		No.	560340	Ref. No.	—
		hexagonal nut thread M4 H 3.2mm WS 7 SS DIN/ISO DIN 934 / ISO 4032/8673 Qty 1 pcs			
		No.	601413	Ref. No.	—
		fixing plate suitable for fanwheel ED ø 32mm shaft ø 7 mounting distance 26mm			

N series - standard



1	<b>No.</b>	601527	<b>Ref. No.</b>	RC00A807
<b>description</b> fan motor 16W 230V 50/60Hz W 84mm 1300rpm VN16-38				

IMPORT

multi fit fan motors



1	<b>No.</b>	601022	<b>Ref. No.</b>	RD000512
<b>description</b> fan motor 10W 230V 50-60Hz L1 44mm L2 54mm L3 85mm W 84mm cable length 500mm 1300rpm YZF10-20-18/26 5 mounting options bearing slide bearing				



1	<b>No.</b>	601023	<b>Ref. No.</b>	RD000513
<b>description</b> fan motor 16W 230V 50-60Hz L1 45mm L2 61mm L3 92mm W 84mm cable length 500mm 1300rpm YZF16-25-18/26 5 mounting options bearing slide bearing				



1	<b>No.</b>	601020	<b>Ref. No.</b>	RD000511
<b>description</b> fan motor 5W 230V 50-60Hz L1 44mm L2 48mm L3 79mm W 84mm cable length 500mm 1300rpm YZF5-13-18/26 5 mounting options bearing slide bearing				

accessories

fan wheels

aluminium

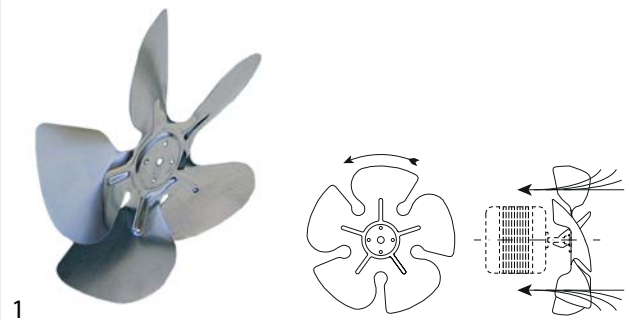

1	<b>No.</b>	601069	<b>Ref. No.</b>	RD000518
<b>description</b> fan wheel sucking ø 172mm turn direction left fan wheel mounting 25.4mm blade angle 25° W 32mm aluminium				

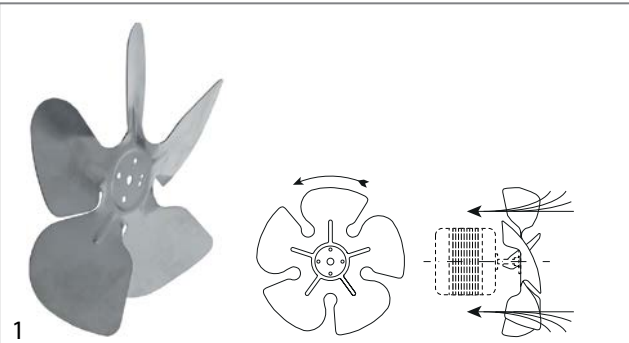

1	<b>No.</b>	601070	<b>Ref. No.</b>	RD000519
<b>description</b> fan wheel sucking ø 200mm fan wheel mounting 25.4mm blade angle 28° W 38mm aluminium				

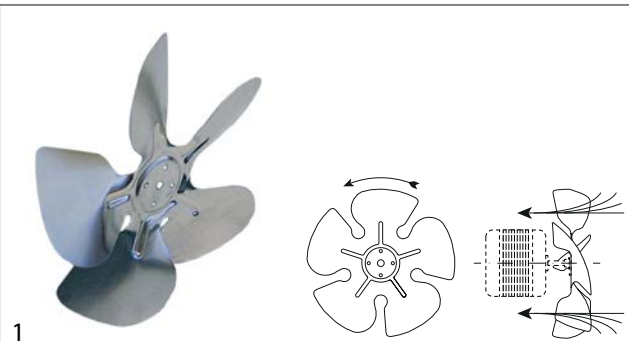

1	<b>No.</b>	601071	<b>Ref. No.</b>	RD000520
<b>description</b> fan wheel sucking ø 230mm fan wheel mounting 25.4mm blade angle 25° W 37mm aluminium				

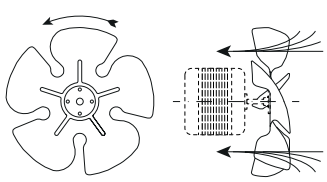
1

<b>No.</b>	601409	<b>Ref. No.</b>	RD000521 RD00A629
<b>description</b>	fan wheel sucking ø 254mm fan wheel mounting 25.4mm blade angle 25° W 38mm aluminium		

1

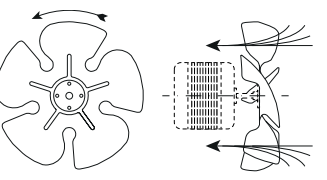
<b>No.</b>	601410	<b>Ref. No.</b>	RD000499
<b>description</b>	fan wheel sucking ø 300mm fan wheel mounting 25.4mm blade angle 28° W 45mm aluminium		

cooling motors (various)

refrigeration motors with foot



1

<b>No.</b>	601419	<b>Ref. No.</b>	926111
<b>description</b>	fan motor 20W 230V 50/60Hz L1 42mm L3 91.5mm W 83mm feet depth 88mm cable length 500mm connection with plug		

cold air circulating fans (complete)

COPREL

AX series

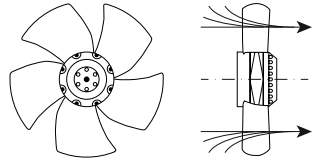
1

<b>No.</b>	601078	<b>Ref. No.</b>	RD000508 RD000510	
<b>description</b>	fan blowing 230V 18W 50Hz fan wheel ø 130mm shaft L 21mm feet depth 29mm connection left			
<b>spare parts for</b>	601078			
	<b>No.</b>	510923	<b>Ref. No.</b>	—
clamping ring for shaft ø 10mm ID ø 9.4mm H 6mm				

1

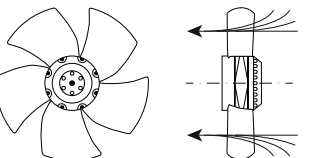
<b>No.</b>	601079	<b>Ref. No.</b>	RD000509
<b>description</b>	fan sucking 230V 18W 50Hz fan wheel ø 130mm shaft L 20mm feet depth 31mm connection right		

miscellaneous



1

<b>No.</b>	601411	<b>Ref. No.</b>	RD000508
<b>description</b>	fan 230V		



## motors

## gear motors

for ice-cube maker

for paddles



1

<b>No.</b>	500407	<b>Ref. No.</b>	926061 RG000636 RG636
<b>description</b>	gear motor LIP type 123MR 8W 220/240V voltage AC 50/60Hz 50rpm turn direction counterclockwise shaft $\varnothing$ 4mm shaft intake $\varnothing$ 6.2mm groove width 2.3mm shaft L 8mm shaft $\varnothing$ 4mm W 74mm		

for sumps



1

<b>No.</b>	500412	<b>Ref. No.</b>	RG000640
<b>description</b>	gear motor LIP type 021B 11W 230V 50Hz 1rpm shaft $\varnothing$ 7mm shaft length 20mm W 74mm D 67mm H 110mm for sump		



1

<b>No.</b>	500688	<b>Ref. No.</b>	926060 RG000640 RG00A684
<b>description</b>	gear motor LIP type 068 11W 230V voltage AC 50Hz 1rpm shaft $\varnothing$ 7mm shaft length 20mm W 75mm D 80mm H 110mm for sump shaft with transverse hole		



1

<b>No.</b>	502284	<b>Ref. No.</b>	AS928050
<b>description</b>	gear motor LIP type 123MR 11W 220/240V voltage AC 50/60Hzrpm shaft $\varnothing$ mm W 110mm D 120mm H 145mm complete		

## miscellaneous



1

<b>No.</b>	500788	<b>Ref. No.</b>	RG000650
<b>description</b>	gear motor 230V		

## motors

for ice-cube maker

complete



1

<b>No.</b>	500787	<b>Ref. No.</b>	926058 RG000647
<b>description</b>	motor 180W 230V 50/60HzHz 1 phase shaft $\varnothing$ 12.8mm 1300rpm RPM 0.18kW		



## pumps

### drain pumps

#### HANNING



1

<b>No.</b>	501519	<b>Ref. No.</b>	926142
<b>description</b>	drain pump 30W 220-240V inlet ø 24mm outlet ø 24mm 50Hz type DPS25-383N HANNING		



1

<b>No.</b>	499316	<b>Ref. No.</b>	926149
<b>description</b>	drain pump 45W 220-240V inlet ø 24mm outlet ø 24mm 50Hz type DPO40-077N HANNING		

## condensators & interference suppression filters

### filters

#### RC circuits



1

<b>No.</b>	365211	<b>Ref. No.</b>	926105
<b>description</b>	interference suppression filter type XRY RC MKPX2 275V connection plug		

## electric accessories

### terminals

#### connection terminals with screw/faston connections



1

<b>No.</b>	550411	<b>Ref. No.</b>	RI000709
<b>description</b>	power terminal block 6-pole max. 40A max 450V connection ø6mm <sup>2</sup> / F6.3 temp.-resist. 150°C cross section 6mm <sup>2</sup>		

## equipment-specific units

### for ice-cube maker

#### drain systems

#### miscellaneous



1

<b>No.</b>	692296	<b>Ref. No.</b>	910055
<b>description</b>	mounting flange for drain unit mounting distance 46mm ID ø 22mm L 13mm plastic		

#### ice chutes

#### slide grates



1

<b>No.</b>	692097	<b>Ref. No.</b>	RN00A017 RNA017
<b>description</b>	slide grate for ice-cube maker L 160mm W 170mm H 60mm		



#### gearboxes

1

<b>No.</b>	695383	<b>Ref. No.</b>	RG000649
<b>description</b>	gearbox		

			
1			
<b>No.</b>	695382	<b>Ref. No.</b>	RG000646
<b>description</b>	gearbox H 140mm L 160mm W 150mm shaft L 23mm drive shaft $\phi$ 11.5mm		

doors			
doors			
			
1			
<b>No.</b>	698942	<b>Ref. No.</b>	910069 AS910069 RP00A667
<b>description</b>	door W 378mm H 245mm plastic		

pan mechanics			
sumps			
			
1			
<b>No.</b>	695358	<b>Ref. No.</b>	910003 RH00A004
<b>description</b>	sump for ice maker L 180mm W 140mm H 60mm EUROFRIGOR white		
			
1			
<b>No.</b>	695359	<b>Ref. No.</b>	RH00A005 RHA005
<b>description</b>	sump for ice maker L 180mm W 180mm H 60mm EUROFRIGOR		

			
1			
<b>No.</b>	695360	<b>Ref. No.</b>	910005 RH00A006
<b>description</b>	sump for ice maker L 180mm W 245mm H 60mm EUROFRIGOR white		

			
1			
<b>No.</b>	695361	<b>Ref. No.</b>	RM00A050
<b>description</b>	sump for ice maker L 330mm W 195mm H 60mm		

			
1			
<b>No.</b>	695362	<b>Ref. No.</b>	RM00A079
<b>description</b>	sump for ice maker L 465mm W 200mm H 70mm		

			
1			
<b>No.</b>	695363	<b>Ref. No.</b>	RM00A047
<b>description</b>	sump for ice maker L 690mm W 200mm H 70mm		

spare parts and accessories			
			
1			
<b>No.</b>	695376	<b>Ref. No.</b>	923067 RQ001152
<b>description</b>	adjusting ring for spindle H 7mm ID $\phi$ 6mm ED $\phi$ 12mm thread M4 stainless steel		

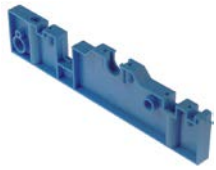
			
1			
<b>No.</b>	695364	<b>Ref. No.</b>	RH003616
<b>description</b>	bracket for sump		

			
1			
<b>No.</b>	695365	<b>Ref. No.</b>	923002 RQ003619
<b>description</b>	bush for impulse		





			
1			
<b>No.</b>	695367	<b>Ref. No.</b>	RH003618
<b>description</b>	lever for pan tilting		

			
1			
<b>No.</b>	695030	<b>Ref. No.</b>	910009 RH00A008
<b>description</b>	lever for pan tilting new edition EUROFRIGOR		

			
1			
<b>No.</b>	695031	<b>Ref. No.</b>	RH00669 RM1063
<b>description</b>	lever for pan tilting old edition EUROFRIGOR		

			
1			
<b>No.</b>	695032	<b>Ref. No.</b>	RH000675 RH675
<b>description</b>	paddle short ø 135mm shaft intake ø 6mm shaft lengthmm 1		

			
1			
<b>No.</b>	695368	<b>Ref. No.</b>	RQ003626
<b>description</b>	pin for pan tilting		

			
1			
<b>No.</b>	695369	<b>Ref. No.</b>	RQ003625
<b>description</b>	spindle for ice maker ø 6mm L 160mm		

			
1			
<b>No.</b>	695370	<b>Ref. No.</b>	RQ00A028
<b>description</b>	spindle for ice maker ø 6mm L 195mm		

			
1			
<b>No.</b>	695371	<b>Ref. No.</b>	RQ00A029
<b>description</b>	spindle for ice maker ø 6mm L 235mm		

			
1			
<b>No.</b>	695378	<b>Ref. No.</b>	RQ000976
<b>description</b>	spindle for ice maker ø 6mm L 235mm		

			
1			
<b>No.</b>	695372	<b>Ref. No.</b>	RQ00A030
<b>description</b>	spindle for ice maker ø 6mm L 300mm		

			
1			
<b>No.</b>	695373	<b>Ref. No.</b>	923006 RQ00A062
<b>description</b>	spindle for ice maker ø 6mm L 380mm		

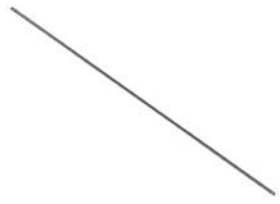
			
1			
<b>No.</b>	695374	<b>Ref. No.</b>	RQ00A075
<b>description</b>	spindle for ice maker ø 6mm L 517mm		

			
1			
<b>No.</b>	695375	<b>Ref. No.</b>	RQ00A063
<b>description</b>	spindle for ice maker ø 6mm L 742mm		

			
1			
<b>No.</b>	695028	<b>Ref. No.</b>	RQ00A064
<b>description</b>	spindle for pan tilting		



mechanics for evaporators

gear motors

motors



1

<b>No.</b>	500787	<b>Ref. No.</b>	926058 RG000647
<b>description</b>	motor 180W 230V 50/60Hz 1 phase shaft ø 12.8mm 1300rpm RPM 0.18kW		

hoses

formed hoses

straight

silicone hoses



1

<b>No.</b>	530472	<b>Ref. No.</b>	913048
<b>description</b>	drain hose ID ø 19mm ED ø 24mm L 280mm		



1

<b>No.</b>	530879	<b>Ref. No.</b>	913037210
<b>description</b>	drain hose straight ID ø 19mm ED ø 24mm L 210mm		

hose connectors

without thread



1

<b>No.</b>	695055	<b>Ref. No.</b>	RH003285+A716+B267
<b>description</b>	hose connector		



1

<b>No.</b>	695054	<b>Ref. No.</b>	RH000665
<b>description</b>	hose connector for ice-cube maker		



1

<b>No.</b>	695056	<b>Ref. No.</b>	910066+913011+910058 RH003286+A716+B267
<b>description</b>	hose connector for ice-cube maker		

1			
<b>No.</b>	695029	<b>Ref. No.</b>	RQ00A065
<b>description</b>	spindle for pan tilting ø 6mm length external size 31mm L 26mm EUROFRIGOR		

1			
<b>No.</b>	695366	<b>Ref. No.</b>	910012 RH003620
<b>description</b>	wheel for pan tilting ø 100mm		

drive technology

1			
<b>No.</b>	695384	<b>Ref. No.</b>	RV003202
<b>description</b>	toothed belt disc disc ø 38mm shaft intake ø 13mm groove depth 5mm disc width 13mm groove width 10x10mm overall width 22mm splitting 5 shaft ø 23.5mm		

1			
<b>No.</b>	695386	<b>Ref. No.</b>	RV003201
<b>description</b>	toothed belt disc large type ES40-100		

housing and bezels

1			
<b>No.</b>	698789	<b>Ref. No.</b>	926073
<b>description</b>	gearbox L 140mm W 100mm H 122mm model RDV40		





			
1			
<b>No.</b>	692349	<b>Ref. No.</b>	910025 + 910055
<b>description</b>	hose connector hose ø 10/20/22mm L 127mm plastic with holder drain system		

			
1			
<b>No.</b>	695057	<b>Ref. No.</b>	910013 AS910013 RH001080
<b>description</b>	hose connector hose ø 12mm L 100mm L-shape plastic		

floats

float containers

			
1			
<b>No.</b>	695070	<b>Ref. No.</b>	RH000828
<b>description</b>	float container		

			
1			
<b>No.</b>	695073	<b>Ref. No.</b>	RH00B632
<b>description</b>	float container		
<b>spare parts for</b>	695073		
	<b>No.</b>	346872	<b>Ref. No.</b>
			RI000800
	 microswitch with lever 250V 0.1A 1CO connection male faston 6.3mm L 50mm ambient temperature max. 85°C mounting distance 22mm type D41X actuating force: 6g lever length 36mm		

for ice crusher

V-belts

			
1			
<b>No.</b>	695387	<b>Ref. No.</b>	RV00A296
<b>description</b>	V-belt pulley single disc ø 128mm shaft intake ø 14mm groove depth 14mm disc width 19mm groove width 4mm overall width 35mm aluminium		

refrigeration cycle components

filter driers

miscellaneous

			
1			
<b>No.</b>	750226	<b>Ref. No.</b>	RF000546
<b>description</b>	dryer size 20g ø 24mm L 117mm connection 6.2/6.3mm		

transmission technology and ball bearings

drive belts

toothed belts

			
1			
<b>No.</b>	695388	<b>Ref. No.</b>	913003 RV003233 RV00B075
<b>description</b>	toothed belt profile XL L 196mm H 2mm teeth 98 splitting rubber with textile insertion CODE 196XL W 10mm type BI 4 164		

springs

compression springs

			
1			
<b>No.</b>	695034	<b>Ref. No.</b>	923030 RR003629
<b>description</b>	compression spring ø 10mm L 35mm wire gauge ø 1.7mm		





## hoses

### drain hoses

			
1			
<b>No.</b>	530726	<b>Ref. No.</b>	913041 913042 RH001181
<b>description</b>	drain hose DN19 L 1530mm A int. ø 19mm A ext. ø 23mm B int. ø 22mm B ext. ø 28mm outer hose ø 24mm		

			
1			
<b>No.</b>	530724	<b>Ref. No.</b>	RH001180
<b>description</b>	drain hose DN19 L 180mm A int. ø 19mm A ext. ø 27mm B int. ø 19mm B ext. ø 27mm outer hose ø 24mm		

			
1			
<b>No.</b>	530727	<b>Ref. No.</b>	RH001177
<b>description</b>	drain hose DN19 L 280mm A int. ø 19mm A ext. ø 27mm B int. ø 19mm B ext. ø 27mm outer hose ø 24mm		

			
1			
<b>No.</b>	530725	<b>Ref. No.</b>	RH001176
<b>description</b>	drain hose L 210mm A int. ø 19mm B int. ø 19mm outer hose ø 24mm		

			
1			
<b>No.</b>	530728	<b>Ref. No.</b>	RH001182
<b>description</b>	drain hose L 270mm A int. ø 19mm A ext. ø 27mm B int. ø 19mm B ext. ø 27mm outer hose ø 24mm		

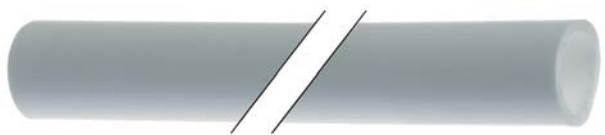
			
1			
<b>No.</b>	530778	<b>Ref. No.</b>	913037190
<b>description</b>	silicone hose DN19 L 180mm A int. ø 19mm B int. ø 19mm outer hose ø 24mm		

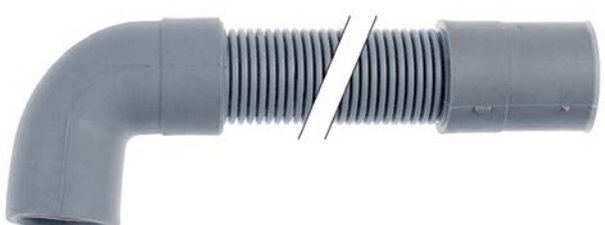
			
1			
<b>No.</b>	530722	<b>Ref. No.</b>	RH001175
<b>description</b>	drain hose DN19 L 180mm straight ø inside 19mm straight ext. ø 25mm elbow ø inside 21mm elbow ext. ø 27mm outer hose ø 24mm		

## formed hoses

### miscellaneous

			
1			
<b>No.</b>	530458	<b>Ref. No.</b>	RH001178
<b>description</b>	formed hose ext. ø 23 ID ø 18mm L 380mm white Qty 1		

## fastening material

### fasteners

#### retaining rings

DIN 6799

			
1			
<b>No.</b>	528709	<b>Ref. No.</b>	RR3644
<b>description</b>	retaining ring E D1 ø 4mm D2 ø 9mm steel DIN 6799 thickness 0.7mm for shaft ø 5-7mm		