

# Professionall

Solutii profesionale pentru echipamente profesionale



**GAS COMPONENTS**



**ELECTRIC COMPONENTS**



**WATER TECHNOLOGY**



**MECHANICAL COMPONENTS**



**TOOLS**

Spare parts suitable for



# ASCOBLOC

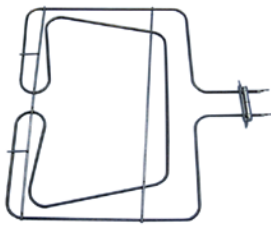

## heating elements

### heating elements for ovens

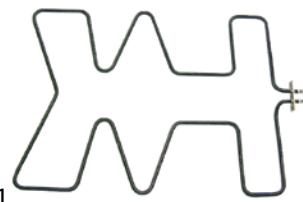
 <p>1</p>			
<b>No.</b>	415995	<b>Ref. No.</b>	9294281
<b>description</b>	heating element 1500W 400V heating circuits 1 L 460mm W 484mm L1 107mm L2 360mm W1 211mm W2 62mm flange length 104mm flange width 32mm hole distance 96/39mm hole ø 4mm tube ø 6.4mm connection male faston 6.3mm connection length 51mm tilt flange dry heating element		
<b>For models:</b>	AEH413, AEH503, AEH613, AEH703		

 <p>1</p>			
<b>No.</b>	415861	<b>Ref. No.</b>	09/3347
<b>description</b>	heating element 3000W 400V heating circuits 1 L 607mm W 447mm L1 25mm L2 580mm W1 200mm W2 32mm flange length 70mm flange width 22mm hole distance 28mm hole ø 3.5mm tube ø 8.5mm connection M5 rectangular flange dry heating element		
<b>accessories for</b>	415861		
	<b>No.</b>	510368	<b>Ref. No.</b> —
	gasket L 70mm W 23.5mm hole ø 5mm hole distance 56mm FIBER thickness 2mm for heating element		
	<b>No.</b>	699566	<b>Ref. No.</b> —
	connection terminal for heating element		

### heating elements for bain maries

 <p>1</p>			
<b>No.</b>	416912	<b>Ref. No.</b>	09 1343 9174025
<b>description</b>	heating element 750W 230V heating circuits 1 L 375mm W 200mm connection male faston 6.3mm connection distance 193mm tube ø 6.25mm dry heating element bain marie		
<b>For models:</b>	AEW250, AEW400, AEW408, AEW450, AEW452		

## heating elements for fryers

### 2 hole fixing



  <p>1</p>			
<b>No.</b>	415591	<b>Ref. No.</b>	9294087
<b>description</b>	heating element 2000W 230V heating circuits 1 L 285mm W 40mm H 240mm H1 200mm H2 40mm mounting pos. 20 thread M14x1.5 tube ø 8.5mm mounting distance 20mm windings 3 2 hole fixing connection male faston 6.3mm immersion heater		
<b>For models:</b>	AEF124, AEF128, AEF224		
<b>spare parts for</b>	415591		
	<b>No.</b>	510417	<b>Ref. No.</b> —
	flat gasket fibre ED ø 20mm ID ø 14mm thickness 2mm Qty 1 pcs		
<b>accessories for</b>	415591		
	<b>No.</b>	520228	<b>Ref. No.</b> —
	tooth lock washer ID ø 15.3mm ED ø 24mm steel Qty 1 pcs for thread M14		
	<b>No.</b>	520230	<b>Ref. No.</b> —
	nut thread M14x1.5 H 5mm WS 19 zinc-coated steel Qty 1 pcs		
	<b>No.</b>	521101	<b>Ref. No.</b> —
	nut thread M14x1.5 H 5mm WS 19 SS Qty 1 pcs		
	<b>No.</b>	550262	<b>Ref. No.</b> —
	flat gasket copper ED ø 20mm ID ø 14mm thickness 2mm		

### heating elements for transport containers

 <p>1</p>			
<b>No.</b>	415706	<b>Ref. No.</b>	09/3407
<b>description</b>	heating element 275W 230V L 399mm W 31mm dry heating element rectangular flange tube ø 6.5mm heating circuits 1 cable length 950mm flange length 40mm flange width 22mm hole ø 5mm connection length 40mm		

pilot heating elements



1			
<b>No.</b>	415607	<b>Ref. No.</b>	8181729
<b>description</b>	heating element 500W 230V heating circuits 1 thread 3/4" L 295mm W 20mm H 19mm length thermostat sleeves 235mm thermostat sleeves ø 6mm number of thermostat sleeves 1 thermostat sleeve clinging tube ø 6.5mm immersion heater flange with thread connection length 50mm pilot heating element		
<b>For models:</b>	AES060, AES080		
<b>spare parts for</b>	415607		
	No.	510403	Ref. No. —
flat gasket fibre ED ø 36.5mm ID ø 27mm thickness 2mm Qty 1 pcs			
<b>accessories for</b>	415607		
	No.	510421	Ref. No. —
gasket copper ED ø 31.8mm ID ø 26.4mm thickness 2.2mm for thread 3/4"			
	No.	520234	Ref. No. —
nut thread 3/4" H 5mm brass WS 30 Qty 1 pcs			







immersion heating elements

with round flange ø47.5mm



1			
<b>No.</b>	418147	<b>Ref. No.</b>	9294496
<b>description</b>	heating element 6000W 230V heating circuits 3 immersion heater round flange mounting ø 47.5mm		
<b>For models:</b>	AES060, AES080		
<b>accessories for</b>	418147		
	No.	510408	Ref. No. 9298045
O-ring EPDM thickness 5.34mm ID ø 47mm Qty 1 pcs			
	No.	510562	Ref. No. 08 1008 8060842
O-ring silicone thickness 5.34mm ID ø 47mm Qty 1 pcs			
	No.	520235	Ref. No. —
3 hole flange hole distance 70.5mm perforation ø 6.5mm ID ø 53.5mm			
	No.	520236	Ref. No. —
flange for heating element ID ø 50mm ED ø 90mm hole ø 6.5mm 3 holes			
	No.	550002	Ref. No. 9294008
tension strap H 10mm L 21mm W 10mm hole ø 6.5mm for heating element			
	No.	550362	Ref. No. —
blind flange ø 64mm mounting ø 47.5mm			



1			
<b>No.</b>	415405	<b>Ref. No.</b>	09 1942 9294203 9294496
<b>description</b>	heating element 6000W 230V heating circuits 3 L 465mm W 38mm H 24mm tube ø 6.3mm connection male faston 6.3mm immersion heater round flange mounting ø 47.5mm		
<b>For models:</b>	AES060, AES080		
<b>spare parts for</b>	415405		
	No.	504148	Ref. No. —
boiler			
<b>accessories for</b>	415405		
	No.	520235	Ref. No. —
3 hole flange hole distance 70.5mm perforation ø 6.5mm ID ø 53.5mm			
	No.	520236	Ref. No. —
flange for heating element ID ø 50mm ED ø 90mm hole ø 6.5mm 3 holes			
	No.	521012	Ref. No. —
gasket graphite ED ø 15mm ID ø 5mm thickness 1.2mm Qty 1 pcs			
	No.	550002	Ref. No. 9294008
tension strap H 10mm L 21mm W 10mm hole ø 6.5mm for heating element			
	No.	550362	Ref. No. —
blind flange ø 64mm mounting ø 47.5mm			

heating elements for convection



1			
<b>No.</b>	415841	<b>Ref. No.</b>	09/3388
<b>description</b>	heating element 3000W 230V heating circuits 1 ID ø 192mm ED ø 205mm L 220mm H 36mm L1 17mm W1 30mm H1 12mm H2 24mm flange length 70mm flange width 22mm hole distance 28mm connection male faston 6.3mm tube ø 6.3mm convection heating element hole ø 4.5mm rectangular flange		
<b>accessories for</b>	415841		
	No.	510368	Ref. No. —
gasket L 70mm W 23.5mm hole ø 5mm hole distance 56mm FIBER thickness 2mm for heating element			

1

<b>No.</b>	415845	<b>Ref. No.</b>	99/186
<b>description</b>	heating element 3150W 230V heating circuits 3 ID ø 201mm ED ø 215mm L 272mm H 35mm L1 57mm W1 60mm H1 8mm H2 27mm flange length 95mm flange width 22mm hole distance 77mm connection male faston 6.3mm connection length 20mm tube ø 6.5mm convection heating element hole ø 6mm rectangular flange		



1

<b>No.</b>	490220	<b>Ref. No.</b>	09/3332 09-3332 HKK
<b>description</b>	radiation heater rectangular 7750W 400V L 500mm W 460mm H 52mm heating circuits 3 connections screw		

radiation heaters

square



1

<b>No.</b>	490207	<b>Ref. No.</b>	093303
<b>description</b>	radiation heater L 300mm W 300mm 2350/1150W 400V heating circuits 2 connections 2 square connection type grip connection without pan detection		



1

<b>No.</b>	416907	<b>Ref. No.</b>	09 1020 09 1021 8160350 8160351
<b>description</b>	radiation heater rectangular 3500W 400V L 415mm W 275mm H 46mm heating circuits 2 connections 2		
<b>For models:</b>	AEB230, AEB238, AEB430, AEB438, AEP500, AEP508		



1

<b>No.</b>	416895	<b>Ref. No.</b>	09 - 1357 9174101
<b>description</b>	radiation heater rectangular 5200W 230V L 530mm W 300mm heating circuits 2		

1-circuit



1

<b>No.</b>	490047	<b>Ref. No.</b>	09/1356
<b>description</b>	radiation heater ø 230mm 2100W 230V heating circuits 1 7-position control with temperature signalization connections 4+2 connection type male faston 6.3mm EGO		



1

<b>No.</b>	490132	<b>Ref. No.</b>	9174100
<b>description</b>	radiation heater ø 230mm 2100W 230V heating circuits 1 7-position control without temperature signalization 7-position control connection type male faston 6.3mm EGO		
<b>For models:</b>	AEH300, AEH308, AEH500, AEH503, AEH508, AEH700, AEH703, AEH708		

2-circuit



1

<b>No.</b>	490028	<b>Ref. No.</b>	8181713
<b>description</b>	radiation heater ø 230mm 2100W 230V heating circuits 2 energy regulation with temperature signalization partial power 650W with heating coil connections 3+2 connection type male faston 6.3mm EGO		
<b>For models:</b>	AEH300, AEH308, AEH500, AEH503, AEH508, AEH700, AEH703, AEH708		



## accessories

## sealing washers

## O-rings

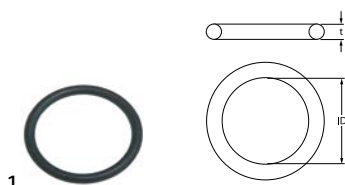

<b>No.</b>	510408	<b>Ref. No.</b>	9298045
------------	--------	-----------------	---------

**description** O-ring EPDM thickness 5.34mm ID ø 47mm Qty 1 pcs

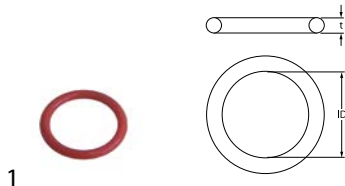

<b>No.</b>	510562	<b>Ref. No.</b>	08 1008 8060842
------------	--------	-----------------	--------------------

**description** O-ring silicone thickness 5.34mm ID ø 47mm Qty 1 pcs

**For models:** AES060, AES080

## flange gaskets

## counterflanges



<b>No.</b>	550002	<b>Ref. No.</b>	9294008
------------	--------	-----------------	---------

**description** tension strap H 10mm L 21mm W 10mm hole ø 6.5mm for heating element



<b>No.</b>	550002	<b>Ref. No.</b>	9294008
------------	--------	-----------------	---------

**description** tension strap H 10mm L 21mm W 10mm hole ø 6.5mm for heating element

## energy regulators

## EGO

## 1-circuit



<b>No.</b>	380016	<b>Ref. No.</b>	8183237
------------	--------	-----------------	---------

**description** energy regulator 230V 12A dual circuit turn direction right with operation switch 1-pole

**For models:** AEH300, AEH308, AEH500, AEH503, AEH508, AEH700, AEH703, AEH708



<b>No.</b>	380015	<b>Ref. No.</b>	8183150
------------	--------	-----------------	---------

**description** energy regulator 230V 13A single-circuit turn direction right shaft ø 6x4.6mm shaft L 23mm mounting thread M4 power release 6-100% no. 50.57021.010

**For models:** AES060, AES080

## accessories

## knobs



<b>No.</b>	110235	<b>Ref. No.</b>	18/604
------------	--------	-----------------	--------

**description** knob energy regulator 1-3 t.max.°C ø 50mm shaft ø 6x4.6mm shaft flat upper black

## thermostats

## bi-metal thermostats

## bi-metal thermostats



<b>No.</b>	390609	<b>Ref. No.</b>	9186200
------------	--------	-----------------	---------

**description** bi-metal thermostat 1NC



<b>No.</b>	390483	<b>Ref. No.</b>	09/1933 09/9294101
------------	--------	-----------------	-----------------------

**description** bi-metal thermostat hole distancemm switch-off temp. 65°C 1NO 1-pole 16A connection F6.3 M4

**For models:** AEH413, AEH503, AEH613, AEH703





control and safety thermostats

EGO

control thermostats

55.13\_ series



<b>No.</b>	375505	<b>Ref. No.</b>	1687 8174681
<b>description</b>	thermostat t.max. 320°C temperature range 50-320°C 1-pole 1NO 16A probe ø 3mm probe L 160mm capillary pipe 870mm capillary pipe isolated gland nut shaft ø 6x4.6mm shaft L 23mm shaft position upper rotation 270°		
<b>For models:</b>	AEB230, AEB238, AEB430, AEB438, AEP500, AEP508, AEW250, AEW400, AEW408, AEW450, AEW452		

55.18\_ series



<b>No.</b>	375483	<b>Ref. No.</b>	09/1687
<b>description</b>	thermostat t.max. 320°C temperature range 50-320°C 1-pole NO 16A probe ø 3mm probe L 158mm capillary pipe 870mm capillary pipe isolated gland nut shaft ø 6x4.6mm shaft L 23mm shaft position upper rotation 270°		

55.34\_ series

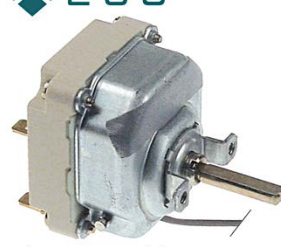

<b>No.</b>	375422	<b>Ref. No.</b>	09-1012 8152105
<b>description</b>	thermostat t.max. 210°C temperature range 95-210°C 3-pole 3NO 16A probe ø 3.1mm probe L 226mm capillary pipe 1780mm capillary pipe isolated 1600mm gland nut shaft ø 6x4.6mm shaft L 23mm shaft position upper rotation 270°		
<b>For models:</b>	AEF124, AEF128, AEF224		



<b>No.</b>	375038	<b>Ref. No.</b>	09/3458
<b>description</b>	thermostat t.max. 300°C temperature range 50-300°C 3-pole 3NO 16A probe ø 6mm probe L 79mm capillary pipe 1740mm capillary pipe isolated 800mm gland nut shaft ø 6x4.6mm shaft L 23mm shaft position upper rotation 270°		
<b>accessories for</b>	375038		
	<b>No.</b>	110123	<b>Ref. No.</b> —
	knob thermostat t.max. 300°C ø 50mm shaft ø 6x4.6mm shaft flat upper black temperature range 50-300°C rotation 270°		

55.40\_ series



<b>No.</b>	375096	<b>Ref. No.</b>	093305
<b>description</b>	thermostat t.max. 450°C temperature range 100-450°C 4-pole 4NO 16A probe ø 3.9mm probe L 163mm capillary pipe 1180mm capillary pipe isolated 850mm gland nut shaft ø 6x4.6mm shaft L 23mm shaft position upper rotation 270°		

safety thermostats

55.33\_ series

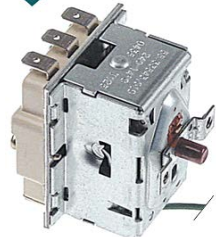

<b>No.</b>	375421	<b>Ref. No.</b>	09-1011 8152102
<b>description</b>	safety thermostat switch-off temp. 240°C 3-pole 20A probe ø 3.1mm probe L 226mm capillary pipe 1170mm capillary pipe isolated 960mm gland nut probe SS		
<b>For models:</b>	AEF124, AEF128, AEF224		

56.\_ series



<b>No.</b>	375447	<b>Ref. No.</b>	09-3689
<b>description</b>	safety thermostat switch-off temp. 150°C 1-pole 1CO 16A probe ø 6mm probe L 77mm capillary pipe 1460mm capillary pipe isolated 1100mm gland nut M9x1 starting temperature 139°C probe		

control thermostats with operation switch

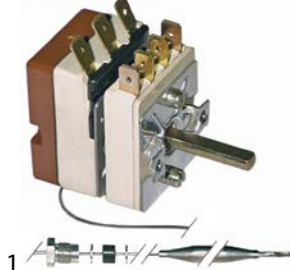

55.13\_ series



<b>No.</b>	375406	<b>Ref. No.</b>	9295433
<b>description</b>	thermostat t.max. 110°C temperature range 30-110°C 1-pole 1CO 16A probe ø 6mm probe L 113mm capillary pipe 2380mm capillary pipe isolated 1700mm gland nut M9x1 shaft ø 6x4.6mm shaft L 18mm shaft position upper rotation 270° outer switch 2NO		

**For models:** AEW250, AEW400, AEW408, AEW450, AEW452

**accessories for** 375406

	<b>No.</b>	110545	<b>Ref. No.</b>	9297019
	knob dial plate silver thermostat t.max. 110°C 30-110°C rotation 310° ED ø 59mm ID ø 45.5mm			
	<b>No.</b>	112173	<b>Ref. No.</b>	—
	knob universal ø 62mm black without adaptor/dial plate			
	<b>No.</b>	112311	<b>Ref. No.</b>	—
	knob adapter shaft ø 6x4.6mm L 0mm with spring			

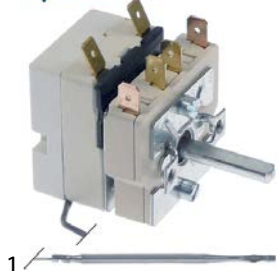

<b>No.</b>	390902	<b>Ref. No.</b>	09/2085 3397
<b>description</b>	thermostat t.max. 320°C temperature range 50-320°C 1-pole 1CO 16A probe ø 3.03mm probe L 160mm capillary pipe 1300mm capillary pipe isolated 1230mm gland nut shaft ø 6x4.6mm shaft L 23mm shaft position upper rotation 270° outer switch 2NO		

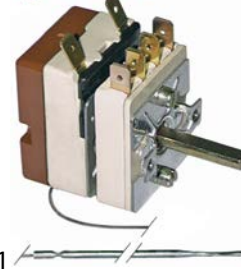

<b>No.</b>	375408	<b>Ref. No.</b>	9295400
<b>description</b>	thermostat t.max. 320°C temperature range 50-320°C 1-pole 1NO 16A probe ø 3.03mm probe L 160mm capillary pipe 1150mm capillary pipe isolatedmm gland nut shaft ø 6x4.6mm shaft L 23mm shaft position upper rotation 270° outer switch 2NO		
<b>For models:</b>	AEB230, AEB238, AEB430, AEB438, AEH413, AEH503, AEH613, AEH703, AEP500, AEP508		



<b>No.</b>	375405	<b>Ref. No.</b>	09/3501
<b>description</b>	thermostat t.max. 90°C temperature range 30-90°C 1-pole 1CO 16A probe ø 6mm probe L 98mm capillary pipe 2380mm capillary pipe isolated 1700mm gland nut M9x1 shaft ø 6x4.6mm shaft L 18mm shaft position upper rotation 270° outer switch 2NO		

CAEM

safety thermostats



<b>No.</b>	390594	<b>Ref. No.</b>	09/3585
<b>description</b>	safety thermostat switch-off temp. 95°C 1-pole 16A probe ø 6mm probe L 80mm capillary pipe 1550mm capillary pipe isolatedmm gland nut probe SS 250V		

various

safety thermostats



<b>No.</b>	390137	<b>Ref. No.</b>	99/186
<b>description</b>	safety thermostat switch-off temp. 95°C 1-pole 16A probe ø 6mm probe L 80mm capillary pipe 1550mm		



accessories

gland nut accessories

ducts



1			
<b>No.</b>	100820	<b>Ref. No.</b>	10/1375
<b>description</b>	gland duct ET M14x1.5 IT M10x0.75 probe ø max. 6.5mm WS 22		

connecting bows



1			
<b>No.</b>	550028	<b>Ref. No.</b>	09/3459
<b>description</b>	connecting bow long for thermostat Qty 10 pcs		

switches and momentary switches

microswitches

pin-plunger actuated



1			
<b>No.</b>	345062	<b>Ref. No.</b>	8177168
<b>description</b>	microswitch with plunger 250V 16A 1NO/1NC connection male faston 6.3mm ambient temperature max. 85°C mounting distance 22mm type BS1012 actuating force: 350g red stroke 8mm		
<b>For models:</b>	AEF124, AEF128, AEF224, AEF494		

M16



1			
<b>No.</b>	345046	<b>Ref. No.</b>	09/3486
<b>description</b>	microswitch with plunger thread M16x1 thread L 25mm 250V 5A 1NC/1NO connection male faston 6.3mm stroke 6mm ambient temperature max. 85°C actuating force: 400g		

position switches

OMRON



1			
<b>No.</b>	346299	<b>Ref. No.</b>	8486038
<b>description</b>	position switch		
<b>For models:</b>	AEP500, AEP508		

cam switches

on/off



1			
<b>No.</b>	300129	<b>Ref. No.</b>	09/1324
<b>description</b>	cam switch 2 operating positions 2NO sequence 0-1 16A shaft ø 6x4.6mm shaft L 23mm connection male faston 6.3mm ceramic		



1			
<b>No.</b>	300102	<b>Ref. No.</b>	09/3306
<b>description</b>	cam switch 4 operating positions 4NO sequence 0-1-0-1 32A shaft ø 6x4.6mm shaft L 23mm connection screw ceramic		

5-position

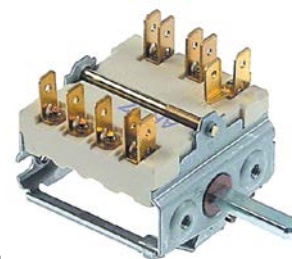

1			
<b>No.</b>	300172	<b>Ref. No.</b>	9173302
<b>description</b>	cam switch 5 operating positions 1NO/2CO sequence 0-1-2-3-4 16A shaft ø 6x4.6mm shaft L 23mm connection male faston 6.3mm 5-position		
<b>For models:</b>	AEH210, AEH218, AEH300, AEH308, AEH410, AEH413, AEH418, AEH500, AEH503, AEH508, AEH610, AEH613, AEH700, AEH703, AEH708		





## 7-position



1

<b>No.</b>	300004	<b>Ref. No.</b>	9295403
<b>description</b>	cam switch 7 operating positions 1NO/2CO sequence 0-1-2-3-4-5-6 16A shaft $\varnothing$ 6x4.6mm shaft L 23mm connection male faston 6.3mm 7-position ceramic		
<b>For models:</b>	AEH300, AEH308, AEH500, AEH503, AEH508, AEH700, AEH703, AEH708		

## 4 operating positions



1

<b>No.</b>	300113	<b>Ref. No.</b>	9296002
<b>description</b>	cam switch 4 operating positions 4NO sequence 0-1-0-2 32A shaft $\varnothing$ 6x4.6mm shaft L 23mm connection screw ceramic		
<b>For models:</b>	AES060, AES080		



1

<b>No.</b>	300179	<b>Ref. No.</b>	9295405
<b>description</b>	cam switch 4 operating positions 4NO/1CO sequence 0-1-0-2 32A shaft $\varnothing$ 6x4.6mm shaft L 23mm connection screw 0-1-0-2 ceramic		
<b>For models:</b>	AEF124, AEF128, AEF224		

## operation switches



1

<b>No.</b>	300200	<b>Ref. No.</b>	09/3460
<b>description</b>	operation switch 2 operating positions 2NO 16A sequence 0-1 shaft $\varnothing$ 6x4.6mm shaft L 23mm connection male faston 6.3mm operation switch ceramic		

## magnetic switches

## miscellaneous



1

<b>No.</b>	347812	<b>Ref. No.</b>	091273
<b>description</b>	magnetic switch 100VDC 0.1A P max. 5W cable length 2000mm 1NC connection cable L 48mm 5W L1 12mm L2 11mm white mounting distance 16-18mm nominal 0.2A		

## control equipment

## MOELLER/EATON

## push buttons - signal lamps



1

<b>No.</b>	346272	<b>Ref. No.</b>	8486105
<b>description</b>	push button mounting measurements $\varnothing$ 22mm green		
<b>For models:</b>	AEP500, AEP508		



1

<b>No.</b>	346271	<b>Ref. No.</b>	8486102
<b>description</b>	push button mounting measurements $\varnothing$ 22mm silver without button plate momentary		
<b>For models:</b>	AEP500, AEP508		

## switch blocks



1

<b>No.</b>	346270	<b>Ref. No.</b>	8486101
<b>description</b>	contact block screw 1NC		
<b>For models:</b>	AEP500, AEP508		

## switches (complete)

## push/momentary push switches



1

<b>No.</b>	347920 <sup>1</sup>	<b>Ref. No.</b>	09/1257
<b>description</b>	momentary push switch mounting measurements $\varnothing$ 22mm green illuminated, 80-264V 2NO protection cap momentary		

<sup>1</sup>with rubber cap



## lamps

### indicator lights

#### indicator lights (complete)

ø16mm

with screw socket



1

<b>No.</b>	359835	<b>Ref. No.</b>	09/2092 9295408
<b>description</b>	indicator light ø 16mm 230V green connection male faston 6.3mm		
<b>For models:</b>	AEB230, AEB238, AEB430, AEB438, AEF124, AEF128, AEF224, AEH210, AEH218, AEH300, AEH308, AEH410, AEH413, AEH418, AEH500, AEH503, AEH508, AEH610, AEH613, AEH700, AEH703, AEH708, AEP500, AEP508, AES060, AES080, AEW250, AEW400, AEW408, AEW450, AEW452		
<b>accessories for</b>	359835		
	<b>No.</b>	550559	<b>Ref. No.</b> —
nut thread M16x1 H 5.5mm WS 19			



1

<b>No.</b>	359834	<b>Ref. No.</b>	09/2091
<b>description</b>	indicator light ø 16mm 230V yellow connection male faston 6.3mm temp.-resist. 120°C		
<b>accessories for</b>	359834		
	<b>No.</b>	550559	<b>Ref. No.</b> —
nut thread M16x1 H 5.5mm WS 19			

with plug-in socket



1

<b>No.</b>	359166	<b>Ref. No.</b>	9295407
<b>description</b>	indicator light ø 16mm 230V white		
<b>For models:</b>	AEF124, AEF128, AEF224, AES060, AES080, AEW250, AEW400, AEW408, AEW450, AEW452		



1

<b>No.</b>	359198	<b>Ref. No.</b>	9295409
<b>description</b>	indicator light ø 16mm 400V white		
<b>For models:</b>	AEB230, AEB238, AEB430, AEB438, AEH413, AEH503, AEH613, AEH703, AEP500, AEP508		

## contactors

### ABB

#### power contactors



1

<b>No.</b>	380092	<b>Ref. No.</b>	09-1035
<b>description</b>	power contactor resistive load 20A 230VAC (AC3/400V) 12A/5.5kW main contacts 4NO auxiliary contacts connection screw connection type B6-40-00 / B7-40-00		

### ISKRA (FANAL)

#### power contactors



1



<b>No.</b>	380418	<b>Ref. No.</b>	8486100
<b>description</b>	power contactor resistive load 20A 24VDC (AC3/400V) 8.5A/5.5kW main contacts 3NO auxiliary contacts 1NO connection screw connection type Fanal DSL7 10 type ISKRA K07MG 10		
<b>For models:</b>	AEP500, AEP508		

## relays

### plug-in/print relays



1

<b>No.</b>	380500	<b>Ref. No.</b>	091274
<b>description</b>	print relay 12VDC 2CO at 250V 8A connection pins raster size 5mm REIPOL		
<b>accessories for</b>	380500		
	<b>No.</b>	380340	<b>Ref. No.</b> —
relay socket dimensions 62x36x15mm 250V voltage AC 10A Italiana Relè manuf. no. ZMEM/5			
	<b>No.</b>	380505	<b>Ref. No.</b> —
relay socket 2CO 40.52 dimensions 81.9x15.5x75mm 250V voltage AC 10A FINDER manuf. no. 95.95.3			
	<b>No.</b>	381181	<b>Ref. No.</b> —
relay socket 2-pole 40.51/40.52/40.61 connection screw clamp dimensions 15.8x78.6mm 250V voltage AC 10A FINDER manuf. no. 95.75			

level relays

miscellaneous



1	<b>No.</b>	380346	<b>Ref. No.</b>	9177191
<b>description</b> level relay 1CO 230V voltage AC				



1	<b>No.</b>	380486	<b>Ref. No.</b>	9177191
<b>description</b> level relay 1CO type CM-ENS				
<b>For models:</b> AEW400, AEW408				

electronics

PCBs



1	<b>No.</b>	401393	<b>Ref. No.</b>	09/3020
<b>description</b> PCB 230V				

pressure switches

for steam control



1	<b>No.</b>	541016	<b>Ref. No.</b>	09/2126 9296000
<b>description</b> pressure control ø 45mm pressure range 480/430mbar pressure connection vertical steam control pressure range 0.48/0.43bar connection 1/4" pressure connection 1/4"				
<b>For models:</b> AES060, AES080				

electrodes



1	<b>No.</b>	400697	<b>Ref. No.</b>	04/10257 915000648
<b>description</b> level electrode PG16 total length 26mm probe L 20mm insulated probe length 5mm connection M5 ø 29mm				
<b>For models:</b> AEW400, AEW408				
<b>spare parts for</b> 400697				
	<b>No.</b>	550577	<b>Ref. No.</b>	—

fans

cross flow fans

COPREL

with moulded coils



1	<b>No.</b>	601456	<b>Ref. No.</b>	8178463
<b>description</b> cross flow fan roller ø 45mm roller length 180mm laminated core thickness 15mm motor position right 230V/50Hz 26W universal bearing silicone connection male faston 6.3mm -30 up to +100°C 230V 50/60Hz				
<b>For models:</b> AEH413, AEH503, AEH613, AEH703, AGH417, AGH617				

electric accessories

terminals

connection terminals with screw/faston connections



1	<b>No.</b>	550110	<b>Ref. No.</b>	09/3447
<b>description</b> power terminal block 5-pole max. 40A max 250V connection M6/ male faston 6.3mm temp.-resist. 130°C				



gas taps

PEL

21S series



1

No.	101671	Ref. No.	9146369 9146372
<b>description</b>	gas tap PEL type 21S gas inlet pipe flange ø21mm bypass nozzle ø 0.35mm gas outlet M17x1 (tube ø 10mm) thermocouple connection M8x1 pilot connection M10x1 shaft ø 6x4.6mm shaft L 30/23mm shaft flat upper		
<b>For models:</b>	AGH210, AGH218, AGH410, AGH413, AGH417, AGH418, AGH610, AGH613, AGH617, AGH618		
<b>spare parts for</b>	101671		
	No.	100408	Ref. No. —
bypass nozzle type PEL20/21 bore ø 0.35mm thread M5x0.5			
	No.	100908	Ref. No. —
union screw thread M10x1 for pipe ø 4mm Qty 1 pcs			
	No.	101060	Ref. No. —
magnet unit standard L 39mm D1 ø 15.4mm D2 ø 11mm suitable for PEL20-21/JUNKERS/EGA			
	No.	101230	Ref. No. —
thermocouple nut T1: M8x1 T2: M18x1 aluminium			
	No.	101246	Ref. No. —
olive for pipe ø 4mm Qty 1 pcs			
	No.	101803	Ref. No. —
gas tap front part shaft ø 6x4.6mm shaft L 30/23mm shaft flat upper/lower suitable for PEL21			
<b>accessories for</b>	101671		
	No.	100909	Ref. No. —
union screw thread M10x1 for pipe ø 6mm Qty 1 pcs			
	No.	101278	Ref. No. —
olive for pipe ø 10mm Qty 1 pcs			
	No.	101286	Ref. No. —
olive ID ø 6mm Qty 1 pcs			
	No.	101300	Ref. No. —
union nut thread M16x1.5 tube ø 10mm			
	No.	101450	Ref. No. —
olive for pipe ø 8mm L 12.7mm Qty 1 pcs ED ø 10mm			
	No.	101451	Ref. No. —
union nut thread M16x1.5 tube ø 8mm			
	No.	110078	Ref. No. 99/198
knob without symbol ø 70mm shaft ø 6x4.6mm shaft flat universal			

accessories for		101671	
No.	112206	Ref. No.	—
	knob dial plate silver gas tap PEL21/22/23 t.max.°C ED ø 63mm ID ø 45.5mm		

22S/O series



1













No.	101626	Ref. No.	10/1440
<b>description</b>	gas tap PEL type 22S/O gas inlet pipe flange ø27mm bypass nozzle ø 0.35mm gas outlet M20x1.5 (tube ø 12/10mm) thermocouple connection M8x1 pilot connection M10x1 shaft ø 6x4.6mm shaft L 35/21mm shaft flat upper		
<b>spare parts for</b>	101626		
	No.	100259	Ref. No. 10/1416
bypass nozzle type PEL22 bore ø 0.35mm thread M6x0.5			
	No.	101058	Ref. No. —
magnet unit L 39mm D1 ø 15.4mm D2 ø 13.5mm suitable for PEL22/EGA24197 standard			
	No.	101230	Ref. No. —
thermocouple nut T1: M8x1 T2: M18x1 aluminium			
	No.	101240	Ref. No. —
gas connection thread M20x1.5 tube ø 12/10mm for PEL gas taps with gasket and screws horizontal			
	No.	101353	Ref. No. —
flange thread M20x1.5 tube ø 27mm suitable for PEL22			
	No.	101460	Ref. No. —
O-ring ø 12.37mm D1 ø 2.62mm suitable for PEL22			
	No.	101461	Ref. No. —
screw kit suitable for PEL22 Qty 4 pcs			
	No.	101823	Ref. No. —
gas tap front part shaft ø 6x4.6mm shaft L 35/21mm shaft flat upper/lower suitable for PEL22			
	No.	106165	Ref. No. —
gasket ø 27mm			
<b>accessories for</b>	101626		
	No.	100908	Ref. No. —
union screw thread M10x1 for pipe ø 4mm Qty 1 pcs			
	No.	100909	Ref. No. —
union screw thread M10x1 for pipe ø 6mm Qty 1 pcs			
	No.	101246	Ref. No. —
olive for pipe ø 4mm Qty 1 pcs			
	No.	101248	Ref. No. 10/1000
olive for pipe ø 12mm Qty 1 pcs suitable for PEL			

Table continues overleaf

1 gas components



accessories for		101626		
No.	101249	Ref. No.	—	
			olive for pipe ø 10mm Qty 1 pcs	
No.	101250	Ref. No.	—	
			union nut thread M20x1.5 for pipe ø 10mm	
No.	101251	Ref. No.	10/1449	
			union nut thread M20x1.5 for pipe ø 12mm	
No.	101286	Ref. No.	—	
			olive ID ø 6mm Qty 1 pcs	
No.	110078	Ref. No.	99/198	
			knob without symbol ø 70mm shaft ø 6x4.6mm shaft flat universal	
No.	112206	Ref. No.	—	
			knob dial plate silver gas tap PEL21/22/23 t.max.°C ED ø 63mm ID ø 45.5mm	

## alternatives to EGA

## GPEL21 series

with nozzle outlet



1

No.	101606	Ref. No.	10/1378	
<b>description</b>	gas tap alternatives to EGA type GPEL21D with nozzle outlet (without nozzle) gas inlet M15x1 (tube ø 10mm) external nozzle ømm internal nozzle ømm bypass nozzle ø 0.35mm mixing pipe connection M17x1 thermocouple connection M8x1 pilot connection M10x1 shaft ø 6x4.6mm shaft L 31/23mm shaft flat upper			
spare parts for		101606		
No.	100408	Ref. No.	—	
			bypass nozzle type PEL20/21 bore ø 0.35mm thread M5x0.5	
No.	100927	Ref. No.	—	
			torsion spring L 2.8-8.0mm for internal nozzle ø 3mm bore ømm	
No.	101060	Ref. No.	—	
			magnet unit standard L 39mm D1 ø 15.4mm D2 ø 11mm suitable for PEL20-21/JUNKERS/EGA	
No.	101230	Ref. No.	—	
			thermocouple nut T1: M8x1 T2: M18x1 aluminium	
No.	101526	Ref. No.	—	
			O-ring Viton thickness 1.78mm ID ø 4.48mm Qty 1 pcs	
No.	101593	Ref. No.	—	
			adjusting screw for internal nozzle thread M8x0.75	
No.	101803	Ref. No.	—	
			gas tap front part shaft ø 6x4.6mm shaft L 30/23mm shaft flat upper/lower suitable for PEL21	

accessories for		101606		
No.	100908	Ref. No.	—	
			union screw thread M10x1 for pipe ø 4mm Qty 1 pcs	
No.	100909	Ref. No.	—	
			union screw thread M10x1 for pipe ø 6mm Qty 1 pcs	
No.	100926	Ref. No.	—	
			centring piece thread M17x1	
No.	100927	Ref. No.	—	
			torsion spring L 2.8-8.0mm for internal nozzle ø 3mm bore ømm	
No.	100942	Ref. No.	—	
			union nut thread M15x1 for pipe ø 10mm	
No.	100943	Ref. No.	—	
			union nut thread M17x1 tube ø 10mm	
No.	101246	Ref. No.	—	
			olive for pipe ø 4mm Qty 1 pcs	
No.	101278	Ref. No.	—	
			olive for pipe ø 10mm Qty 1 pcs	
No.	101286	Ref. No.	—	
			olive ID ø 6mm Qty 1 pcs	
No.	110078	Ref. No.	99/198	
			knob without symbol ø 70mm shaft ø 6x4.6mm shaft flat universal	
No.	112206	Ref. No.	—	
			knob dial plate silver gas tap PEL21/22/23 t.max.°C ED ø 63mm ID ø 45.5mm	

## EGA

## 26440 series

gas taps









1

No.	104260	Ref. No.	151001	
<b>description</b>	gas tap EGA type 26440 series			
spare parts for		104260		
No.	100346	Ref. No.	—	
			bypass nozzle EGA type 31248 series bore ø 0.85mm	
No.	100395	Ref. No.	—	
			internal nozzle bore ø 1.4mm suitable for EGA26400/26440	
No.	101060	Ref. No.	—	
			magnet unit standard L 39mm D1 ø 15.4mm D2 ø 11mm suitable for PEL20-21/JUNKERS/EGA	
No.	101230	Ref. No.	—	
			thermocouple nut T1: M8x1 T2: M18x1 aluminium	













accessories for		104260		
No.	Ref. No.	—		
	100942	Ref. No.	—	
union nut thread M15x1 for pipe ø 10mm				
	101278	Ref. No.	—	
olive for pipe ø 10mm Qty 1 pcs				
	101284	Ref. No.	—	
olive for pipe ø 4mm Qty 1 pcs				
	101285	Ref. No.	—	
union screw thread M8x1 for pipe ø 4mm Qty 1 pcs JUNKERS				
	110078	Ref. No.	99/198	
knob without symbol ø 70mm shaft ø 6x4.6mm shaft flat universal				
	112206	Ref. No.	—	
knob dial plate silver gas tap PEL21/22/23 t.max.°C ED ø 63mm ID ø 45.5mm				











accessories for		101905		
No.	Ref. No.	—		
	101286	Ref. No.	—	
olive ID ø 6mm Qty 1 pcs				
	101300	Ref. No.	—	
union nut thread M16x1.5 tube ø 10mm				
	101450	Ref. No.	—	
olive for pipe ø 8mm L 12.7mm Qty 1 pcs ED ø 10mm				
	101451	Ref. No.	—	
union nut thread M16x1.5 tube ø 8mm				
	110079	Ref. No.	—	
knob dial plate gas thermostat 1-8 silver				
	110081	Ref. No.	—	
knob ø 70mm shaft ø 8x6.5mm shaft flat universal				

## gas thermostats

### PEL

#### 25ST series

			
1			
No.	Ref. No.	10-1352	
<b>description</b> gas thermostat PEL type 25ST 100-200°C gas inlet pipe flange ø21mm bypass nozzle ø 0.35mm gas outlet M16x1.5 (tube ø 10/8mm) thermocouple connection M9x1 pilot connection M10x1 capillary pipe 1200mm probe ø 6mm probe L 120mm shaft ø 8x6.5mm shaft L 21/15mm shaft flat upper			
spare parts for		101905	
	No. 100259	Ref. No.	10/1416
bypass nozzle type PEL22 bore ø 0.35mm thread M6x0.5			
	No. 101060	Ref. No.	—
magnet unit standard L 39mm D1 ø 15.4mm D2 ø 11mm suitable for PEL20-21/JUNKERS/EGA			
	No. 106200	Ref. No.	—
nut thread M9x1 suitable for PEL 24/25S			
accessories for		101905	
	No. 100908	Ref. No.	—
union screw thread M10x1 for pipe ø 4mm Qty 1 pcs			
	No. 100909	Ref. No.	—
union screw thread M10x1 for pipe ø 6mm Qty 1 pcs			
	No. 101246	Ref. No.	—
olive for pipe ø 4mm Qty 1 pcs			
	No. 101278	Ref. No.	—
olive for pipe ø 10mm Qty 1 pcs			

			
1			
No.	Ref. No.	10/1351	
<b>description</b> gas thermostat PEL type 25ST 50-300°C gas inlet pipe flange ø21mm bypass nozzle ø 0.35mm gas outlet M16x1.5 (tube ø 10/8mm) thermocouple connection M9x1 pilot connection M10x1 capillary pipe 1200mm probe ø 6mm probe L 100mm shaft ø 8x6.5mm shaft L 21/15mm shaft flat upper			
spare parts for		101901	
	No. 100259	Ref. No.	10/1416
bypass nozzle type PEL22 bore ø 0.35mm thread M6x0.5			
	No. 101060	Ref. No.	—
magnet unit standard L 39mm D1 ø 15.4mm D2 ø 11mm suitable for PEL20-21/JUNKERS/EGA			
	No. 106200	Ref. No.	—
nut thread M9x1 suitable for PEL 24/25S			
accessories for		101901	
	No. 100908	Ref. No.	—
union screw thread M10x1 for pipe ø 4mm Qty 1 pcs			
	No. 100909	Ref. No.	—
union screw thread M10x1 for pipe ø 6mm Qty 1 pcs			
	No. 101246	Ref. No.	—
olive for pipe ø 4mm Qty 1 pcs			
	No. 101278	Ref. No.	—
olive for pipe ø 10mm Qty 1 pcs			
	No. 101286	Ref. No.	—
olive ID ø 6mm Qty 1 pcs			
	No. 101300	Ref. No.	—
union nut thread M16x1.5 tube ø 10mm			



accessories for		101901		
No.	101450	Ref. No.	—	
	olive for pipe ø 8mm L 12.7mm Qty 1 pcs ED ø 10mm			
No.	101451	Ref. No.	—	
	union nut thread M16x1.5 tube ø 8mm			
No.	110079	Ref. No.	—	
	knob dial plate gas thermostat 1-8 silver			
No.	110081	Ref. No.	—	
	knob ø 70mm shaft ø 8x6.5mm shaft flat universal			

## ignition parts

### pilot burners

#### SIT

#### 100 series

#### accessories

#### pilot burner bottom parts

1			
No.	100880	Ref. No.	08/8032
<b>description</b>	pilot burner bottom part SIT 100 series nozzle ø 0.4mm		

#### pilot burner nozzles

1			
No.	102545	Ref. No.	10/1350
<b>description</b>	pilot burner nozzle LPG code 20 bore ø 0.2mm Qty 5 pcs		

#### JUNKERS

#### CB 502 series

#### pilot burners















1			
No.	100125	Ref. No.	9294282
<b>description</b>	pilot burner JUNKERS type CB502024		
spare parts for		100125	
	No.	100228	Ref. No. —
	pilot burner nozzle town gas gas pressure 8mbar code 4 Qty 1 pcs suitable for JUNKERS CB50203_		
	No.	100719	Ref. No. —
	ignition electrode D1 ø 7mm D2 ø 9mm connection M4 L1 12mm L2 17mm BL1 18mm BL2 3mm BL3 23mm		
	No.	100906	Ref. No. —
	screw connection thread M10x1 for ignition electrode brass Qty 1 pcs WS 10		

spare parts for		100125		
No.	100907	Ref. No.	—	
	screw connection thread M10x1 Qty 1 pcs type SEF 1 ømm for thermocouple			
No.	101281	Ref. No.	—	
	olive for pipe ø 4mm L 8.7mm Qty 1 pcs suitable for CB 502/503			
No.	101283	Ref. No.	—	
	union screw thread M10x1 for pipe ø 4mm Qty 1 pcs			
accessories for		100125		
No.	100220	Ref. No.	—	
	pilot burner nozzle LPG gas pressure 50mbar code 2 Qty 1 pcs suitable for JUNKERS CB503_			
No.	100221	Ref. No.	—	
	pilot burner nozzle LPG gas pressure 30mbar code 29 Qty 1 pcs suitable for JUNKERS CB50203_			
No.	100222	Ref. No.	—	
	pilot burner nozzle LPG gas pressure 50mbar code 5 Qty 1 pcs suitable for JUNKERS CB50203_			
No.	100223	Ref. No.	—	
	pilot burner nozzle natural gas gas pressure 20mbar code 3 Qty 1 pcs suitable for JUNKERS CB503_			
No.	100224	Ref. No.	—	
	pilot burner nozzle natural gas gas pressure 25mbar code 26 Qty 1 pcs suitable for JUNKERS CB503_			
No.	100225	Ref. No.	—	
	pilot burner nozzle LPG gas pressure 30mbar code 39 Qty 1 pcs suitable for JUNKERS CB503_			
No.	100226	Ref. No.	—	
	pilot burner nozzle LPG gas pressure 50mbar code 15 suitable for JUNKERS			
No.	100227	Ref. No.	—	
	pilot burner nozzle natural gas gas pressure 25mbar code 6 Qty 1 pcs suitable for JUNKERS CB50203_			
No.	100909	Ref. No.	—	
	union screw thread M10x1 for pipe ø 6mm Qty 1 pcs			
No.	101287	Ref. No.	—	
	olive for pipe ø 6mm Qty 1 pcs			

1			
No.	100085	Ref. No.	9264282
<b>description</b>	pilot burner JUNKERS type CB502031 natural gas nozzle no.6 gas connection 6mm with primary air		
<b>For models:</b>	AGB230, AGB238, AGB430, AGB438, AGF124, AGF128, AGF224, AGF228		
spare parts for		100085	
	No.	100227	Ref. No. —
	pilot burner nozzle natural gas gas pressure 25mbar code 6 Qty 1 pcs suitable for JUNKERS CB50203_		

Table continues overleaf



spare parts for		100085	
	No.	100704	Ref. No. —
ignition electrode D1 ø 9mm connection M4 D2 ø 11mm L1 17mm L2 17mm BL1 13mm BL2 4mm BL3 22mm			
	No.	100909	Ref. No. —
union screw thread M10x1 for pipe ø 6mm Qty 1 pcs			
	No.	101287	Ref. No. —
olive for pipe ø 6mm Qty 1 pcs			
	No.	101292	Ref. No. —
union screw for igniter suitable for CB 502/505 Qty 1 pcs			
	No.	101295	Ref. No. —
clamping collet for thermocouple suitable for CB 502/505 Qty 1 pcs			
accessories for		100085	
	No.	100220	Ref. No. —
pilot burner nozzle LPG gas pressure 50mbar code 2 Qty 1 pcs suitable for JUNKERS CB503_			
	No.	100221	Ref. No. —
pilot burner nozzle LPG gas pressure 30mbar code 29 Qty 1 pcs suitable for JUNKERS CB50203_			
	No.	100222	Ref. No. —
pilot burner nozzle LPG gas pressure 50mbar code 5 Qty 1 pcs suitable for JUNKERS CB50203_			
	No.	100223	Ref. No. —
pilot burner nozzle natural gas gas pressure 20mbar code 3 Qty 1 pcs suitable for JUNKERS CB503_			
	No.	100224	Ref. No. —
pilot burner nozzle natural gas gas pressure 25mbar code 26 Qty 1 pcs suitable for JUNKERS CB503_			
	No.	100225	Ref. No. —
pilot burner nozzle LPG gas pressure 30mbar code 39 Qty 1 pcs suitable for JUNKERS CB503_			
	No.	100226	Ref. No. —
pilot burner nozzle LPG gas pressure 50mbar code 15 suitable for JUNKERS			
	No.	100228	Ref. No. —
pilot burner nozzle town gas gas pressure 8mbar code 4 Qty 1 pcs suitable for JUNKERS CB50203_			
	No.	101281	Ref. No. —
olive for pipe ø 4mm L 8.7mm Qty 1 pcs suitable for CB 502/503			
	No.	101283	Ref. No. —
union screw thread M10x1 for pipe ø 4mm Qty 1 pcs			

CB 503 series			
pilot burners			
	1		
No.	100058	Ref. No.	9290540
description pilot burner JUNKERS type CB503006 natural gas nozzle no.26 gas connection 4mm			
For models: AGH417, AGH617			
spare parts for		100058	
	No.	100224	Ref. No. —
pilot burner nozzle natural gas gas pressure 25mbar code 26 Qty 1 pcs suitable for JUNKERS CB503_			
	No.	101281	Ref. No. —
olive for pipe ø 4mm L 8.7mm Qty 1 pcs suitable for CB 502/503			
	No.	101283	Ref. No. —
union screw thread M10x1 for pipe ø 4mm Qty 1 pcs			
accessories for		100058	
	No.	100220	Ref. No. —
pilot burner nozzle LPG gas pressure 50mbar code 2 Qty 1 pcs suitable for JUNKERS CB503_			
	No.	100221	Ref. No. —
pilot burner nozzle LPG gas pressure 30mbar code 29 Qty 1 pcs suitable for JUNKERS CB50203_			
	No.	100222	Ref. No. —
pilot burner nozzle LPG gas pressure 50mbar code 5 Qty 1 pcs suitable for JUNKERS CB50203_			
	No.	100223	Ref. No. —
pilot burner nozzle natural gas gas pressure 20mbar code 3 Qty 1 pcs suitable for JUNKERS CB503_			
	No.	100226	Ref. No. —
pilot burner nozzle LPG gas pressure 50mbar code 15 suitable for JUNKERS			
	No.	100227	Ref. No. —
pilot burner nozzle natural gas gas pressure 25mbar code 6 Qty 1 pcs suitable for JUNKERS CB50203_			
	No.	100228	Ref. No. —
pilot burner nozzle town gas gas pressure 8mbar code 4 Qty 1 pcs suitable for JUNKERS CB50203_			
	No.	100909	Ref. No. —
union screw thread M10x1 for pipe ø 6mm Qty 1 pcs			
	No.	101287	Ref. No. —
olive for pipe ø 6mm Qty 1 pcs			
	No.	102110	Ref. No. —
pilot tube copper pipe ø 4mm thickness 1mm L 3000mm			
	No.	102111	Ref. No. —
pilot tube copper pipe ø 6mm thickness 1mm L 3000mm			



producer-specific pilot burners

ASCOBLOC

AGH\_ series (version 1)

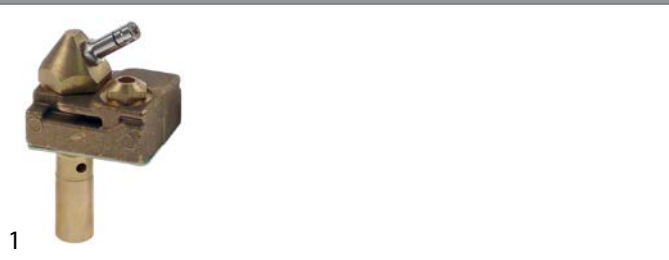

<b>No.</b>	102956	<b>Ref. No.</b>	-
<b>description</b>	pilot burner type C without nozzle		



<b>No.</b>	102957	<b>Ref. No.</b>	-
<b>description</b>	pilot burner type D without nozzle		

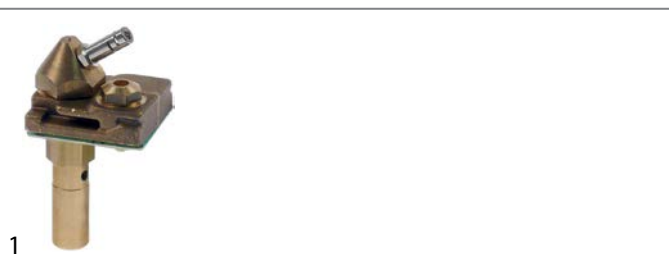

<b>No.</b>	102958	<b>Ref. No.</b>	-
<b>description</b>	pilot burner type E without nozzle		

AGH\_ series (version 2)

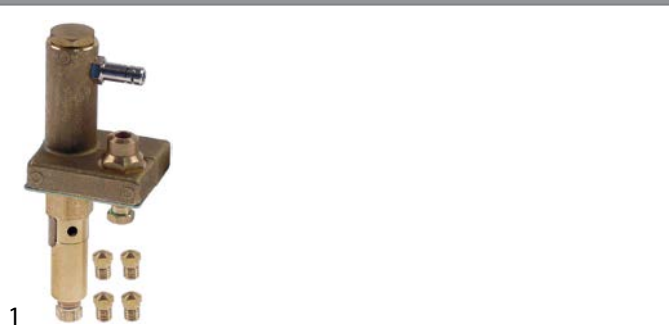

<b>No.</b>	101529	<b>Ref. No.</b>	10 1355 109146500
<b>description</b>	pilot burner type E incl. nozzles 0.18mm / 0.20mm / 0.32mm / 0.35mm		
<b>spare parts for</b>	101529		
	<b>No.</b>	100235	<b>Ref. No.</b> 10/1366
	pilot burner nozzle LPG bore $\varnothing$ 0.2mm code 20 gas pressure 50mbar thread M5x0.8		
	<b>No.</b>	100236	<b>Ref. No.</b> -
	pilot burner nozzle natural gas bore $\varnothing$ 0.35mm code 35 gas pressure 20mbar thread M5x0.8 WS 5.5		

<b>spare parts for</b>	101529		
	<b>No.</b>	100900	<b>Ref. No.</b> -
	air mixing sleeve for pilot burner Qty 1 pcs		
	<b>No.</b>	101583	<b>Ref. No.</b> 10/1107
	pilot burner head slit width 0.8mm bore $\varnothing$ 3mm $\varnothing$ 6mm M7x0.75mm total length 22mm WS 8 nickel-plated brass		
	<b>No.</b>	101587	<b>Ref. No.</b> 9146402
	gasket for pilot burner without ignition electrode		
	<b>No.</b>	101588	<b>Ref. No.</b> 10/1131
	pilot burner nozzle natural gas bore $\varnothing$ 0.32mm code 32 gas pressure 20mbar thread M5x0.8		
	<b>No.</b>	101589	<b>Ref. No.</b> -
	pilot burner nozzle LPG bore $\varnothing$ 0.18mm code 18 gas pressure 50mbar thread M5x0.8 WS 5.5		
	<b>No.</b>	101848	<b>Ref. No.</b> 135690
	cover for pilot burner		

piezoelectric igniters

miscellaneous

	<b>No.</b>	nla <sup>1</sup>	<b>Ref. No.</b>	9296035
	<b>description</b>	piezoelectric igniter body metal connection F6.3x0.8 2 hole fixing $\varnothing$ 22mm		
<b>For models:</b>	AGB230, AGB238, AGB430, AGB438, AGF124, AGF128, AGF224, AGF228			

<sup>1</sup>no longer available

thermocouples

plug-in thermocouples

plug-in thermocouples standard

with barrel socket  $\varnothing$ 5mm - type Junkers with aluminised tip

	<b>No.</b>	102251	<b>Ref. No.</b>	09/3587
	<b>description</b>	thermocouple M9x1 L 750mm plug connection $\varnothing$ 5.0mm		



with barrel socket  $\varnothing 6\text{mm}$

type Junkers with aluminised tip

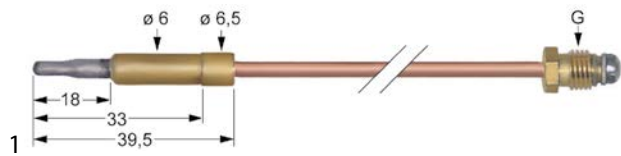

<b>No.</b>	102218	<b>Ref. No.</b>	9296024
<b>description</b>	thermocouple M8x1 L 320mm plug connection $\varnothing 6.0\text{mm}$		
<b>For models:</b>	AGB230, AGB238, AGB430, AGB438, AGH210, AGH218, AGH410, AGH413, AGH417, AGH418, AGH610, AGH613, AGH617, AGH618		

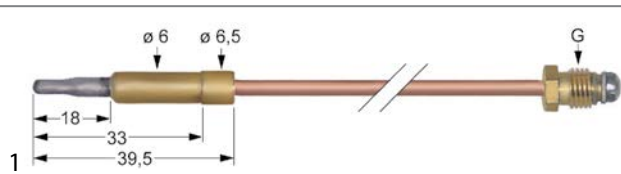

<b>No.</b>	102220	<b>Ref. No.</b>	9296025
<b>description</b>	thermocouple M8x1 L 600mm plug connection $\varnothing 6.0\text{mm}$		
<b>For models:</b>	AGH210, AGH218, AGH410, AGH413, AGH417, AGH418, AGH610, AGH613, AGH617, AGH618		

with barrel socket  $\varnothing 6(6.5)\text{mm}$

thermocouples SIT

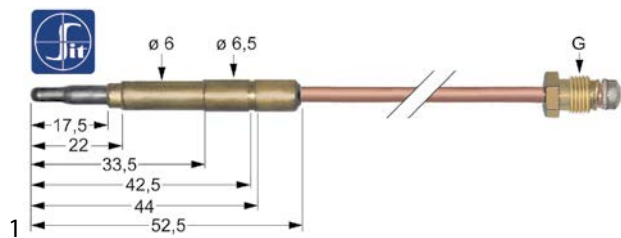

<b>No.</b>	107614	<b>Ref. No.</b>	09 3361 099181121
<b>description</b>	thermocouple SIT M9x1 L 1500mm plug connection $\varnothing 6.0(6.5)\text{mm}$		

thermocouples with aluminised tip

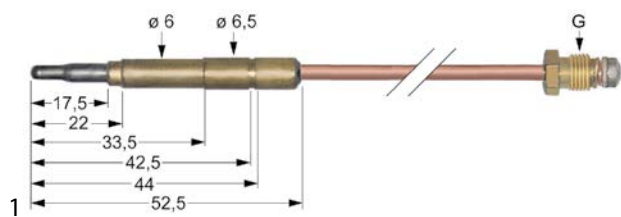

<b>No.</b>	102045	<b>Ref. No.</b>	09/3361
<b>description</b>	thermocouple M9x1 L 1500mm plug connection $\varnothing 6.0(6.5)\text{mm}$		

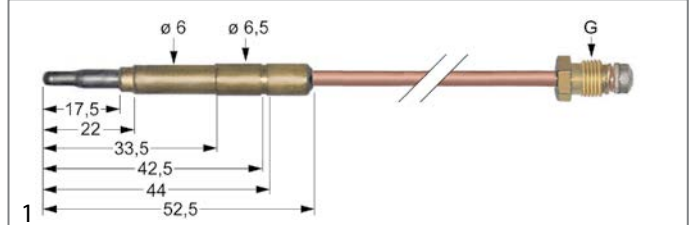

<b>No.</b>	102040	<b>Ref. No.</b>	09/3362
<b>description</b>	thermocouple M9x1 L 500mm plug connection $\varnothing 6.0(6.5)\text{mm}$		

plug-in thermocouples with cable link



<b>No.</b>	102131	<b>Ref. No.</b>	09/3556
<b>description</b>	thermocouple with two-conductors L 1000mm plug connection $\varnothing 5.0\text{mm}$ M8x1		



<b>No.</b>	102089	<b>Ref. No.</b>	9296034
<b>description</b>	thermocouple with two-conductors L 600mm plug connection $\varnothing 5.0\text{mm}$ M8x1		
<b>For models:</b>	AGF124, AGF128, AGF224, AGF228		

plug-in thermocouples with interruption

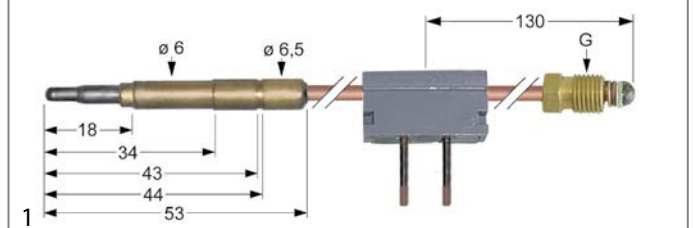

<b>No.</b>	102069	<b>Ref. No.</b>	09/3446
<b>description</b>	thermocouple with interrupter M9x1 L 600mm plug connection $\varnothing 6.0\text{mm}$ soldering connection		

## gas burners

### hob burners

#### producer-specific hob burners

#### ASCOBLOC

#### Ascoline 700, 850 series

<b>No.</b>	104520	<b>Ref. No.</b>	N/A
<b>description</b>	air mixing tube C $\varnothing 16\text{mm}$		





1 			
<b>No.</b>	104521	<b>Ref. No.</b>	N/A
<b>description</b>	air mixing tube D ø 18mm		

1			
<b>No.</b>	104531	<b>Ref. No.</b>	10/1091
<b>description</b>	burner cap		

1 			
<b>No.</b>	104501	<b>Ref. No.</b>	9146383
<b>description</b>	burner cap C/2.3mm ø 83mm		
<b>For models:</b>	AGB230, AGB238, AGB430, AGB438, AGH210, AGH218, AGH410, AGH413, AGH417, AGH418, AGH610, AGH613, AGH617, AGH618		

1 			
<b>No.</b>	104460	<b>Ref. No.</b>	9146389
<b>description</b>	burner cap D ø 94mm 5kW with central hole		
<b>For models:</b>	AGH210, AGH218, AGH410, AGH413, AGH417, AGH418, AGH610, AGH613, AGH617, AGH618		

1 			
<b>No.</b>	104500	<b>Ref. No.</b>	9146387
<b>description</b>	burner head C for burner cap ø 85mm		
<b>For models:</b>	AGB230, AGB238, AGB430, AGB438, AGH210, AGH218, AGH410, AGH413, AGH417, AGH418, AGH610, AGH613, AGH617, AGH618		

1 			
<b>No.</b>	104505	<b>Ref. No.</b>	9146388
<b>description</b>	burner head D for burner cap ø 95mm		
<b>For models:</b>	AGH210, AGH218, AGH410, AGH413, AGH417, AGH418, AGH610, AGH613, AGH617, AGH618		

1 			
<b>No.</b>	104507	<b>Ref. No.</b>	10/1377
<b>description</b>	burner head E for burner cap ø 115mm		

1 			
<b>No.</b>	104502	<b>Ref. No.</b>	9146385
<b>description</b>	burner lower part C for burner cap ø 85mm hole ø 16.5mm		
<b>For models:</b>	AGB230, AGB238, AGB430, AGB438, AGH210, AGH218, AGH410, AGH413, AGH417, AGH418, AGH610, AGH613, AGH617, AGH618		

1 			
<b>No.</b>	104544	<b>Ref. No.</b>	10/1349
<b>description</b>	burner lower part C for burner cap ø 85mm hole ø 16mm		

1 			
<b>No.</b>	104545	<b>Ref. No.</b>	10/1350
<b>description</b>	burner lower part D for burner cap ø 100mm hole ø 16.5mm		

1 			
<b>No.</b>	104504	<b>Ref. No.</b>	9146391
<b>description</b>	burner lower part D for burner cap ø 100mm hole ø 16mm		
<b>For models:</b>	AGH210, AGH218, AGH410, AGH413, AGH417, AGH418, AGH610, AGH613, AGH617, AGH618		

1 			
<b>No.</b>	104712	<b>Ref. No.</b>	10/1379
<b>description</b>	burner lower part E ID ø 18mm complete without mixing pipe		





			
1			
<b>No.</b>	104511	<b>Ref. No.</b>	9146393
<b>description</b>	gasket ø 72mm ID ø 45mm for burner head H 1.2mm perforation ø 5mm		
<b>For models:</b>	AGB230, AGB238, AGB430, AGB438, AGH210, AGH218, AGH410, AGH413, AGH417, AGH418, AGH610, AGH613, AGH617, AGH618		

accessories			
air mixers			
			
1			
<b>No.</b>	101400	<b>Ref. No.</b>	10/1353
<b>description</b>	air mixing tube thread M17x1 suitable for L350, L700		

bar burners			
bar burners			
			
1			
<b>No.</b>	104156	<b>Ref. No.</b>	10/1409
<b>description</b>	bar burner 2 row L 445mm W 200mm ømm H 50mm chargrill stainless steel		

			
1			
<b>No.</b>	105260	<b>Ref. No.</b>	10/1427
<b>description</b>	bar burner 2 row L 445mm W 300mm ømm H 50mm 8.5kW griddle		

			
1			
<b>No.</b>	104163	<b>Ref. No.</b>	99/186
<b>description</b>	bar burner 2 row L 600mm W 300mm ømm griddle		

			
1			
<b>No.</b>	104380	<b>Ref. No.</b>	12767805
<b>description</b>	bar burner ømm W 41mm H 56mm L 216mm fryer		
<b>For models:</b>	AGF124, AGF128, AGF224, AGF228		

ring burners			
			
1			
<b>No.</b>	104189	<b>Ref. No.</b>	10/1373
<b>description</b>	ring burner L 460mm W 245mm for oven		

accessories			
nozzle holders			
			
1			
<b>No.</b>	101852	<b>Ref. No.</b>	10/1158
<b>description</b>	nozzle holder		

			
1			
<b>No.</b>	104522	<b>Ref. No.</b>	10/1318
<b>description</b>	nozzle holder ID ø 10mm ET M17x1		

gas nozzles			
main nozzles			
gas nozzles M12x1			
			
1			
<b>No.</b>	100279	<b>Ref. No.</b>	10/1116
<b>description</b>	gas injector thread M12x1 WS 14 bore ø 0.82mm		

			
1			
<b>No.</b>	100249	<b>Ref. No.</b>	10/1420
<b>description</b>	gas injector thread M12x1 WS 14 bore ø 0.85mm		

			
1			
<b>No.</b>	100283	<b>Ref. No.</b>	10/1381
<b>description</b>	gas injector thread M12x1 WS 14 bore ø 0.90mm		

			
1			
<b>No.</b>	100975	<b>Ref. No.</b>	10/1421
<b>description</b>	gas injector thread M12x1 WS 14 bore ø 1.25mm		

			
1			
<b>No.</b>	100282	<b>Ref. No.</b>	10/1119
<b>description</b>	gas injector thread M12x1 WS 14 bore ø 0.95mm		

			
1			
<b>No.</b>	100286	<b>Ref. No.</b>	10/1397
<b>description</b>	gas injector thread M12x1 WS 14 bore ø 1.30mm		

			
1			
<b>No.</b>	100284	<b>Ref. No.</b>	10/1456
<b>description</b>	gas injector thread M12x1 WS 14 bore ø 1.00mm		

			
1			
<b>No.</b>	100300	<b>Ref. No.</b>	10/1384
<b>description</b>	gas injector thread M12x1 WS 14 bore ø 1.35mm		

			
1			
<b>No.</b>	100662	<b>Ref. No.</b>	10/1424
<b>description</b>	gas injector thread M12x1 WS 14 bore ø 1.05mm		

			
1			
<b>No.</b>	100669	<b>Ref. No.</b>	10/1093
<b>description</b>	gas injector thread M12x1 WS 14 bore ø 1.37mm		

			
1			
<b>No.</b>	100877	<b>Ref. No.</b>	10/1120
<b>description</b>	gas injector thread M12x1 WS 14 bore ø 1.07mm		

			
1			
<b>No.</b>	100287	<b>Ref. No.</b>	10/1422
<b>description</b>	gas injector thread M12x1 WS 14 bore ø 1.45mm		

			
1			
<b>No.</b>	100663	<b>Ref. No.</b>	10/1395
<b>description</b>	gas injector thread M12x1 WS 14 bore ø 1.15mm		

			
1			
<b>No.</b>	100700	<b>Ref. No.</b>	10/1121
<b>description</b>	gas injector thread M12x1 WS 14 bore ø 1.50mm		

			
1			
<b>No.</b>	100306	<b>Ref. No.</b>	10/1396
<b>description</b>	gas injector thread M12x1 WS 14 bore ø 1.20mm		

			
1			
<b>No.</b>	100301	<b>Ref. No.</b>	10/1386
<b>description</b>	gas injector thread M12x1 WS 14 bore ø 1.55mm		





			
1			
<b>No.</b>	100239	<b>Ref. No.</b>	10/1387
<b>description</b>	gas injector thread M12x1 WS 14 bore ø 1.65mm		

			
1			
<b>No.</b>	100292	<b>Ref. No.</b>	10/1398
<b>description</b>	gas injector thread M12x1 WS 14 bore ø 2.10mm		

			
1			
<b>No.</b>	100288	<b>Ref. No.</b>	10/1348
<b>description</b>	gas injector thread M12x1 WS 14 bore ø 1.70mm		

			
1			
<b>No.</b>	100309	<b>Ref. No.</b>	10/1399
<b>description</b>	gas injector thread M12x1 WS 14 bore ø 2.30mm		

			
1			
<b>No.</b>	100878	<b>Ref. No.</b>	10/1388
<b>description</b>	gas injector thread M12x1 WS 14 bore ø 1.75mm		

			
1			
<b>No.</b>	100668	<b>Ref. No.</b>	10/1432
<b>description</b>	gas injector thread M12x1 WS 14 bore ø 2.35mm		

			
1			
<b>No.</b>	100289	<b>Ref. No.</b>	10/1389
<b>description</b>	gas injector thread M12x1 WS 14 bore ø 1.80mm		

			
1			
<b>No.</b>	100749	<b>Ref. No.</b>	10/1400
<b>description</b>	gas injector thread M12x1 WS 14 bore ø 2.45mm		

			
1			
<b>No.</b>	100302	<b>Ref. No.</b>	10/1425
<b>description</b>	gas injector thread M12x1 WS 14 bore ø 1.85mm		

			
1			
<b>No.</b>	100326	<b>Ref. No.</b>	10/1433
<b>description</b>	gas injector thread M12x1 WS 14 bore ø 2.50mm		

			
1			
<b>No.</b>	100290	<b>Ref. No.</b>	10/1426
<b>description</b>	gas injector thread M12x1 WS 14 bore ø 1.90mm		

			
1			
<b>No.</b>	100304	<b>Ref. No.</b>	10/1434
<b>description</b>	gas injector thread M12x1 WS 14 bore ø 2.60mm		

			
1			
<b>No.</b>	100303	<b>Ref. No.</b>	10/1457
<b>description</b>	gas injector thread M12x1 WS 14 bore ø 2.05mm		

			
1			
<b>No.</b>	100295	<b>Ref. No.</b>	10/1435
<b>description</b>	gas injector thread M12x1 WS 14 bore ø 2.70mm		

			
1			
<b>No.</b>	106329	<b>Ref. No.</b>	10/1452
<b>description</b>	gas injector thread M12x1 WS 14 bore ø 2.80mm		

			
1			
<b>No.</b>	106308	<b>Ref. No.</b>	10/1450
<b>description</b>	gas injector thread M12x1 WS 14 bore ø 2.90mm		

			
1			
<b>No.</b>	100305	<b>Ref. No.</b>	10/1446
<b>description</b>	gas injector thread M12x1 WS 14 bore ø 3.00mm		

			
1			
<b>No.</b>	106281	<b>Ref. No.</b>	10/1061
<b>description</b>	gas injector thread M12x1 WS 14 bore ø 3.10mm		

			
1			
<b>No.</b>	100752	<b>Ref. No.</b>	10/1447
<b>description</b>	gas injector thread M12x1 WS 14 bore ø 3.20mm		

			
1			
<b>No.</b>	100296	<b>Ref. No.</b>	10/1448
<b>description</b>	gas injector thread M12x1 WS 14 bore ø 3.30mm		

pilot burner nozzles

pilot burner nozzles EGA

			
1			
<b>No.</b>	100235	<b>Ref. No.</b>	10/1366
<b>description</b>	pilot burner nozzle LPG bore ø 0.2mm code 20 gas pressure 50mbar thread M5x0.8		

			
1			
<b>No.</b>	100215	<b>Ref. No.</b>	10/1367
<b>description</b>	pilot burner nozzle natural gas bore ø 0.28mm Qty 1 pcs		

			
1			
<b>No.</b>	101588	<b>Ref. No.</b>	10/1131
<b>description</b>	pilot burner nozzle natural gas bore ø 0.32mm code 32 gas pressure 20mbar thread M5x0.8		

pilot burner nozzles SIT

100 series

			
1			
<b>No.</b>	102545	<b>Ref. No.</b>	10/1350
<b>description</b>	pilot burner nozzle LPG code 20 bore ø 0.2mm Qty 5 pcs		

pilot burner nozzles (other)

MKN

			
1			
<b>No.</b>	100271	<b>Ref. No.</b>	10/1368
<b>description</b>	pilot burner nozzle natural gas bore ø 0.3mm		

bypass nozzles

bypass nozzles PEL20/21

			
1			
<b>No.</b>	100554	<b>Ref. No.</b>	10/1342
<b>description</b>	bypass nozzle type PEL20/21 bore ø 0.45mm thread M5x0.5		

			
1			
<b>No.</b>	100526	<b>Ref. No.</b>	10/1343
<b>description</b>	bypass nozzle type PEL20/21 bore ø 0.5mm thread M5x0.5		

			
1			
<b>No.</b>	100551	<b>Ref. No.</b>	10/1344
<b>description</b>	bypass nozzle type PEL20/21 bore ø 0.6mm thread M5x0.5		







			
1			
<b>No.</b>	100552	<b>Ref. No.</b>	10/1390
<b>description</b>	bypass nozzle type PEL20/21 bore ø 0.7mm thread M5x0.5		

			
1			
<b>No.</b>	100527	<b>Ref. No.</b>	10/1360
<b>description</b>	bypass nozzle type PEL20/21 bore ø 0.85mm thread M5x0.5		

			
1			
<b>No.</b>	100555	<b>Ref. No.</b>	10/1340
<b>description</b>	bypass nozzle type PEL20/21 bore ø 0.8mm thread M5x0.5		

			
1			
<b>No.</b>	100556	<b>Ref. No.</b>	10/1341
<b>description</b>	bypass nozzle type PEL20/21 bore ø 0.95mm thread M5x0.5		

			
1			
<b>No.</b>	100528	<b>Ref. No.</b>	10/1430
<b>description</b>	bypass nozzle type PEL20/21 bore ø 0.9mm thread M5x0.5		

			
1			
<b>No.</b>	100557	<b>Ref. No.</b>	10/1393
<b>description</b>	bypass nozzle type PEL20/21 bore ø 1.05mm thread M5x0.5		

			
1			
<b>No.</b>	100531	<b>Ref. No.</b>	10/1394
<b>description</b>	bypass nozzle type PEL20/21 bore ø 1.15mm thread M5x0.5		

			
1			
<b>No.</b>	100547	<b>Ref. No.</b>	10/1428
<b>description</b>	bypass nozzle type PEL20/21 bore ø 1.75mm thread M5x0.5		

bypass nozzles PEL22

			
1			
<b>No.</b>	100259	<b>Ref. No.</b>	10/1416
<b>description</b>	bypass nozzle type PEL22 bore ø 0.35mm thread M6x0.5		

			
1			
<b>No.</b>	100391	<b>Ref. No.</b>	10/1402
<b>description</b>	bypass nozzle type PEL22 bore ø 0.55mm thread M6x0.5		

			
1			
<b>No.</b>	100390	<b>Ref. No.</b>	10/1401
<b>description</b>	bypass nozzle type PEL22 bore ø 0.5mm thread M6x0.5		

			
1			
<b>No.</b>	100428	<b>Ref. No.</b>	10/1403
<b>description</b>	bypass nozzle type PEL22 bore ø 0.65mm thread M6x0.5		

			
1			
<b>No.</b>	100392	<b>Ref. No.</b>	10/1391
<b>description</b>	bypass nozzle type PEL22 bore ø 0.6mm thread M6x0.5		

			
1			
<b>No.</b>	100432	<b>Ref. No.</b>	10/1454
<b>description</b>	bypass nozzle type PEL22 bore ø 0.75mm thread M6x0.5		

			
1			
<b>No.</b>	100429	<b>Ref. No.</b>	10/1354
<b>description</b>	bypass nozzle type PEL22 bore ø 0.7mm thread M6x0.5		

			
1			
<b>No.</b>	100410	<b>Ref. No.</b>	10/1363
<b>description</b>	bypass nozzle type PEL22 bore ø 0.85mm thread M6x0.5		

			
1			
<b>No.</b>	100409	<b>Ref. No.</b>	10/1404
<b>description</b>	bypass nozzle type PEL22 bore ø 0.8mm thread M6x0.5		

			
1			
<b>No.</b>	100434	<b>Ref. No.</b>	10/1406
<b>description</b>	bypass nozzle type PEL22 bore ø 0.95mm thread M6x0.5		





			
<b>No.</b>	100433	<b>Ref. No.</b>	10/1405
<b>description</b>	bypass nozzle type PEL22 bore ø 0.9mm thread M6x0.5		

			
<b>No.</b>	100437	<b>Ref. No.</b>	10/1408
<b>description</b>	bypass nozzle type PEL22 bore ø 1.15mm thread M6x0.5		

			
<b>No.</b>	100436	<b>Ref. No.</b>	10/1444
<b>description</b>	bypass nozzle type PEL22 bore ø 1.1mm thread M6x0.5		

			
<b>No.</b>	100438	<b>Ref. No.</b>	10/1445
<b>description</b>	bypass nozzle type PEL22 bore ø 1.2mm thread M6x0.5		

			
<b>No.</b>	100407	<b>Ref. No.</b>	10/1407
<b>description</b>	bypass nozzle type PEL22 bore ø 1mm thread M6x0.5		

<b>bypass nozzles PEL23/24</b>			
			
<b>No.</b>	100493	<b>Ref. No.</b>	10/1441
<b>description</b>	bypass nozzle type PEL23/24 bore ø 0.7mm thread M8x0.5		



			
<b>No.</b>	100649	<b>Ref. No.</b>	10/1442
<b>description</b>	bypass nozzle type PEL23/24 bore ø 1.1mm thread M8x0.5		

			
<b>No.</b>	100664	<b>Ref. No.</b>	10/1443
<b>description</b>	bypass nozzle type PEL23/24 bore ø 1.25mm thread M8x0.5		



## auxiliary gas parts

### screw connections

#### olives

			
<b>No.</b>	101248	<b>Ref. No.</b>	10/1000
<b>description</b>	olive for pipe ø 12mm Qty 1 pcs suitable for PEL		
<b>accessories for</b>	101248		
	<b>No.</b>	101251	<b>Ref. No.</b>
			10/1449
	union nut thread M20x1.5 for pipe ø 12mm		

#### union nuts

			
<b>No.</b>	101251	<b>Ref. No.</b>	10/1449
<b>description</b>	union nut thread M20x1.5 for pipe ø 12mm		
<b>accessories for</b>	101251		
	<b>No.</b>	101248	<b>Ref. No.</b>
			10/1000
	olive for pipe ø 12mm Qty 1 pcs suitable for PEL		

## equipment-specific units

### for deep fryers

#### glass panels

			
<b>No.</b>	691322	<b>Ref. No.</b>	082484
<b>description</b>	glass panel ø 40mm thickness 4mm		

### for tilting bratt pans

#### glass panels

			
<b>No.</b>	691322	<b>Ref. No.</b>	082484
<b>description</b>	glass panel ø 40mm thickness 4mm		



miscellaneous



1

<b>No.</b>	691321	<b>Ref. No.</b>	082484
<b>description</b>	frame		

for boiling pans

glass panels



1

<b>No.</b>	691322	<b>Ref. No.</b>	082484
<b>description</b>	glass panel ø 40mm thickness 4mm		

for ovens

miscellaneous



1

<b>No.</b>	691321	<b>Ref. No.</b>	082484
<b>description</b>	frame		

knobs

universal knobs



1

<b>No.</b>	110235	<b>Ref. No.</b>	18/604
<b>description</b>	knob energy regulator 1-3 t.max.°C ø 50mm shaft ø 6x4.6mm shaft flat upper black		

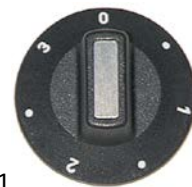

1

<b>No.</b>	110234	<b>Ref. No.</b>	18/603
<b>description</b>	knob switch 7-position t.max.°C ø 50mm shaft ø 6x4.6mm shaft flat upper black		



1

<b>No.</b>	110127	<b>Ref. No.</b>	09/3502
<b>description</b>	knob graduated t.max.°C ø 50mm shaft ø 6x4.6mm shaft flat upper black		
<b>accessories for</b>	110127		
	<b>No.</b>	110135	<b>Ref. No.</b>
			—
	rosette knob up to ø 52mm		

producer-specific knobs

ASCOBLOC



1

<b>No.</b>	112670	<b>Ref. No.</b>	09/2662
<b>description</b>	knob without symbol ø 65mm shaft ø 6x4.6mm shaft flat upper		



## fittings for catering equipment

### drain taps

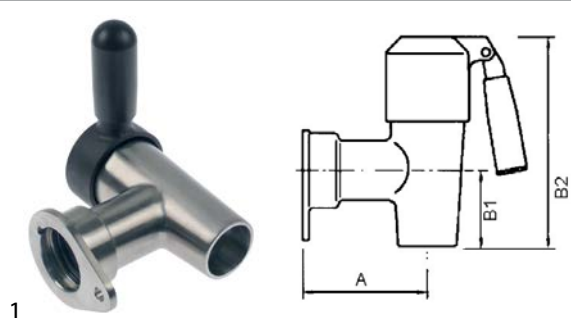

#### stainless steel

#### drain taps

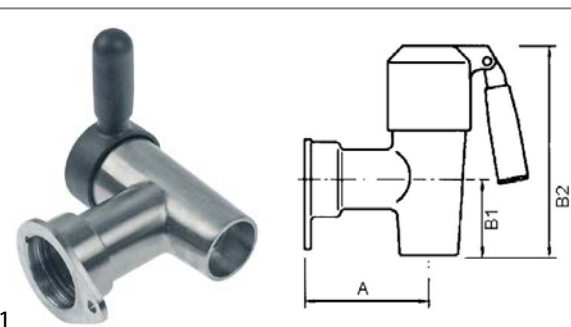

<b>No.</b>	541997	<b>Ref. No.</b>	08/1172 08/8511
<b>description</b>	drain tap connection push-in for pipe $\varnothing$ 47mm A 98mm B1 64mm B2 145mm stainless steel O-ring seal		
<b>spare parts for</b>	541997		
	<b>No.</b>	542174	<b>Ref. No.</b> —
	O-ring set for drain tap 1½" gaskets and grease ECHTERMANN 6726.60/6726.61/6726.62/6726.63		
<b>accessories for</b>	541997		
	<b>No.</b>	890116	<b>Ref. No.</b> —
	fitting grease FERMIT GLISSA tube 60g -20 up to +140°C approval complies with KTW recommendation		



<b>No.</b>	542110	<b>Ref. No.</b>	08/8512
<b>description</b>	drain tap connection push-in for pipe $\varnothing$ 59mm A 120mm B1 65mm B2 158mm stainless steel O-ring seal		
<b>spare parts for</b>	542110		
	<b>No.</b>	542185	<b>Ref. No.</b> —
	O-ring set EPDM for drain tap 2" gaskets and grease		
<b>accessories for</b>	542110		
	<b>No.</b>	890116	<b>Ref. No.</b> —
	fitting grease FERMIT GLISSA tube 60g -20 up to +140°C approval complies with KTW recommendation		
	<b>No.</b>	890118	<b>Ref. No.</b> —
	fitting grease FERMIT GLISSA can 1000g -20 up to +140°C approval complies with KTW recommendation		

### steam traps

#### steam traps

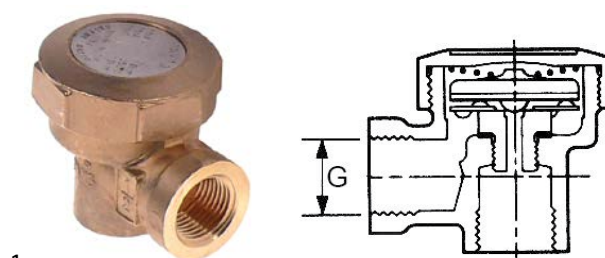

<b>No.</b>	514272	<b>Ref. No.</b>	8150901
<b>description</b>	thermostatic steam trap thread 1/2" type AV13 brass		
<b>For models:</b>	AES060, AES080		

### safety valves



<b>No.</b>	514273	<b>Ref. No.</b>	8151701
<b>description</b>	safety valve T1: 1/2" T2: 1/2" triggering pressure 0.65bar		
<b>For models:</b>	AES060, AES080		

### baskets

#### fryer baskets

#### ASCOBLOC



<b>No.</b>	970159	<b>Ref. No.</b>	9292205
<b>description</b>	fryer basket L1 305mm W1 175mm H1 125mm L2 515mm H2 195mm		
<b>For models:</b>	AEF124, AEF128, AEF224, AEF494		



**gaskets**

**refrigeration gaskets**

plug-in gaskets

profile 9162

universal

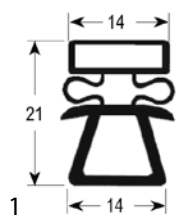

<b>No.</b>	901696	<b>Ref. No.</b>	08/2042
<b>description</b>	refrigeration gasket profile 9162 W 385mm L 595mm external size		

**gaskets for heated units**

door seals with fixing hook

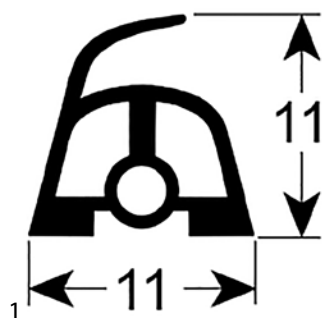

<b>No.</b>	900390	<b>Ref. No.</b>	04/12775005 04/1782
<b>description</b>	door seal L 380mm Wmm with 5 mounting clips		
<b>For models:</b>	AEH413, AEH503, AEH613, AEH703, AGH417, AGH617		

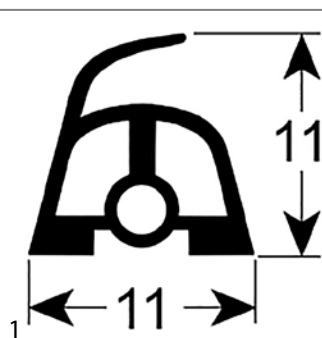

<b>No.</b>	900391	<b>Ref. No.</b>	04/12775105 04/1783
<b>description</b>	door seal L 585mm Wmm with 9 mounting clips		
<b>For models:</b>	AEH413, AEH503, AEH613, AEH703, AGH417, AGH617		

**O-rings**

EPDM

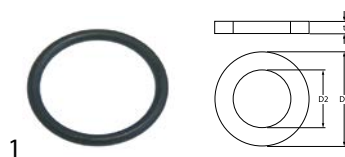

<b>No.</b>	510408	<b>Ref. No.</b>	9298045
<b>description</b>	O-ring EPDM thickness 5.34mm ID ø 47mm Qty 1 pcs		

silicone

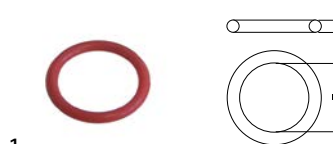

<b>No.</b>	510562	<b>Ref. No.</b>	08 1008 8060842
<b>description</b>	O-ring silicone thickness 5.34mm ID ø 47mm Qty 1 pcs		
<b>For models:</b>	AES060, AES080		

**sealing washers**

Viton gaskets



<b>No.</b>	106250	<b>Ref. No.</b>	08/7300
<b>description</b>	gasket Viton ED ø 14mm ID ø 9mm thickness 3.3mm Qty 1 pcs		



<b>No.</b>	101880	<b>Ref. No.</b>	08/8032
<b>description</b>	gasket Viton ED ø 14mm ID ø 9mm thickness 7.7mm Qty 1 pcs		

**sealing cords**

round



<b>No.</b>	691326	<b>Ref. No.</b>	08/9127800 081505
<b>description</b>	sealing cord round ø 8mm braided Qty supplied by meter		

mechanical components, equipment accessories



## springs

### miscellaneous

1 

<b>No.</b>	700187	<b>Ref. No.</b>	9294387
<b>description</b>	spring for door		
<b>For models:</b>	AEH413, AEH503, AEH613, AEH703, AGH417, AGH617		

## kitchen accessories

### waste chute rings

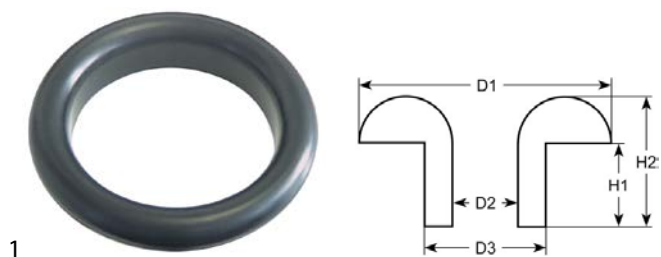

<b>No.</b>	690333	<b>Ref. No.</b>	08/6836
<b>description</b>	waste chute ring D1 $\varnothing$ 234mm D2 $\varnothing$ 166mm D3 $\varnothing$ 200mm D4 $\varnothing$ 218mm H1 24mm H2 47mm		

## manometers



<b>No.</b>	541343	<b>Ref. No.</b>	8151500
<b>description</b>	manometer $\varnothing$ 63mm pressure range 0 up to 1.6bar thread 1/4" marking 0.5-1 kettle connection on the backside		
<b>For models:</b>	AES060, AES080		

## valves and tank inlets

### inlet taps



<b>No.</b>	540887	<b>Ref. No.</b>	8178419
<b>description</b>	inlet tap connection 3/4" ET tube $\varnothing$ 20mm projection 100mm overall height 110mm spout height 40mm rotation 90°		
<b>For models:</b>	AES060, AES080		