

oven hinges

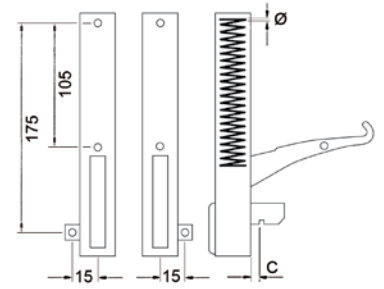
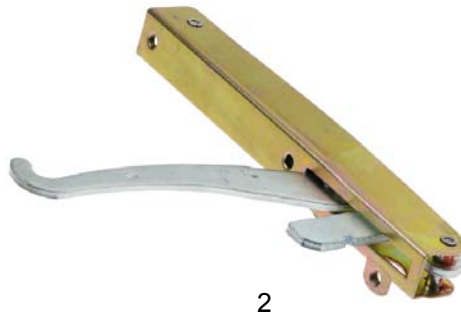
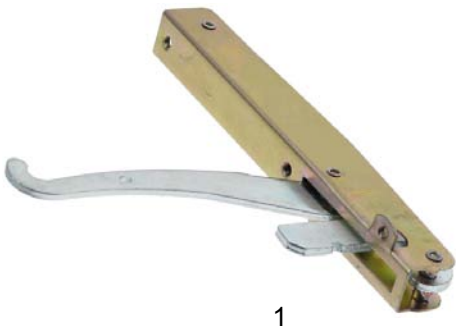

fig.	part no.	mounting ear	ø(mm)	C (mm)	counterpart	suitable for	equiv. no.
1	700004	right	3.5	7	A	Mareno	1304600
1	700007	right	3.5	11	A	universal	
1	690534	right	4.0	11	A	Emmepi	C10080

fig.	part no.	mounting ear	ø(mm)	C (mm)	counterpart	suitable for	equiv. no.
2	700005	left	3.5	7	A	Mareno	1304700
2	700006	left	3.5	11	A	universal	
2	690533	left	4.0	11	A	Emmepi	C10079

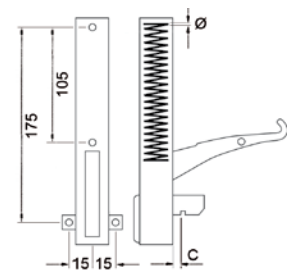
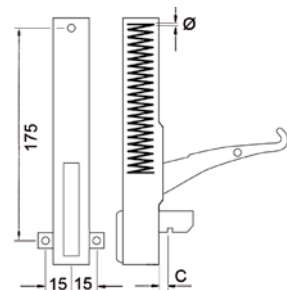

fig.	part no.	mounting ear	ø(mm)	C (mm)	counterpart	suitable for	equiv. no.
1	700164	left/right	3.5	5	A	Mareno	CM041300

fig.	part no.	mounting ear	ø(mm)	C (mm)	counterpart	suitable for	equiv. no.
2	700820	left/right	3.5	11	A	Fagor	U020528000



Pos.	part no.	mounting ear	ø(mm)	C (mm)	counterpart	suitable for	equiv. no.
1	700010	left/right	3	10	A	Electrolux Zanussi Zanussi	0C0203 050766 059277

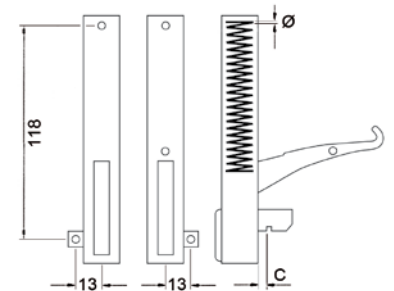
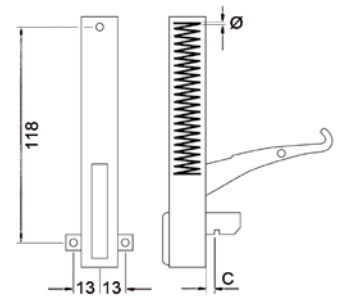

fig.	part no.	mounting ear	ø(mm)	C (mm)	counterpart	suitable for	equiv. no.
1	690349	left	3.8	8	B, C	STAR 10	55905

fig.	part no.	mounting ear	ø(mm)	C (mm)	counterpart	suitable for	equiv. no.
2	690324	right	3.8	8	B, C	STAR 10	55904



no.	part no.	mounting ear	ø(mm)	C (mm)	counterpart	suitable for	equiv. no.
1	700025	left/right	3	8	B, C	universal	



1



2

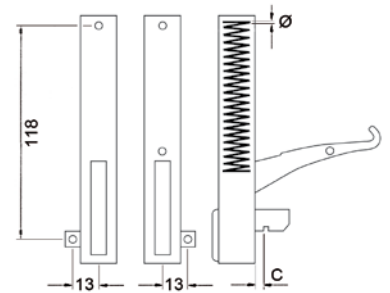

fig.	part no.	mounting ear	ø(mm)	C (mm)	counterpart	suitable for	equiv. no.
1	700676	left	3	8	C, G, H	Smeg	931330289
2	700675	right	3	8	C, F, I	Smeg	931330288



1



2

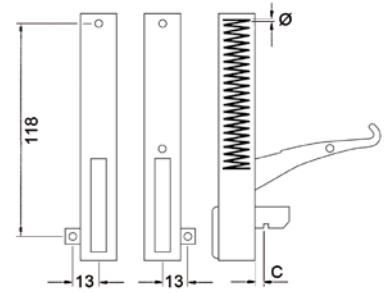

fig.	part no.	mounting ear	ø(mm)	C (mm)	counterpart	suitable for	equiv. no.
1	690499	left	4	12	B	MBM MBM Techninox	9626107100 RIC0002136 RC00803000
2	690498	right	4	12	B	MBM MBM Techninox	9626107000 RIC0002135 RC00802000



1



2

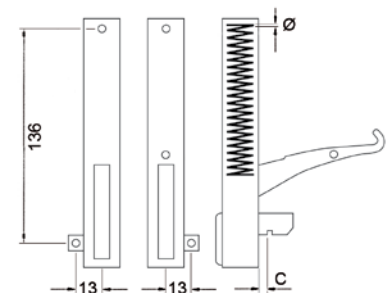
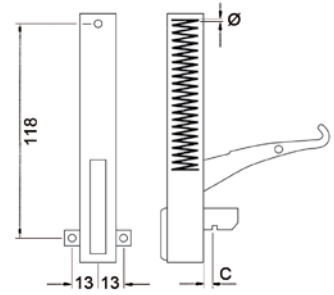

fig.	part no.	mounting ear	ø(mm)	C (mm)	counterpart	suitable for	equiv. no.
1	700674	left	3.8	12	H	Smeg	931330250
1	700669	left	4.2	12	H	Smeg	931330807
2	700673	right	3.8	12	F, K	Smeg	931330249
2	700670	right	4.2	12	K	Smeg	931330808



no.	part no.	mounting ear	ø(mm)	C (mm)	counterpart	suitable for	equiv. no.
1	690032	left/right	3.5	6	D	Lotus	531007300



1



2

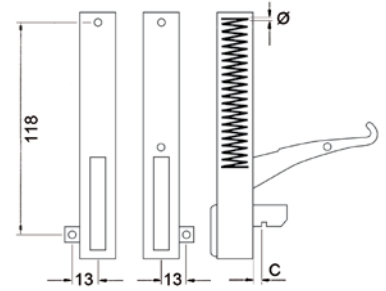
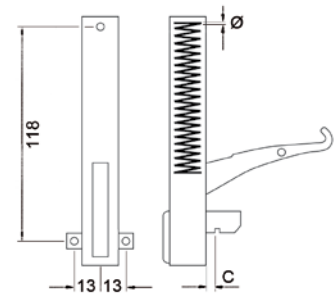

fig.	part no.	mounting ear	ø(mm)	C (mm)	counterpart	suitable for	equiv. no.	fig.	part no.	mounting ear	ø(mm)	C (mm)	counterpart	suitable for	equiv. no.
1	700013	left	3.5	12	B	Berto's Giga Mareno MBM MBM	22607800 X68021 1031102000 9626105100 RIC0002134	2	700014	right	3.5	12	B	Berto's Giga Mareno MBM MBM	22608100 X68020 1031105500 9626105000 RIC0002133



no.	part no.	mounting ear	ø(mm)	C (mm)	counterpart	suitable for	equiv. no.
1	690700	left/right	4	12	B	MBM	9980699512 RIC0003282



1



2

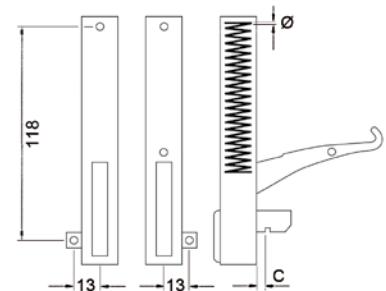
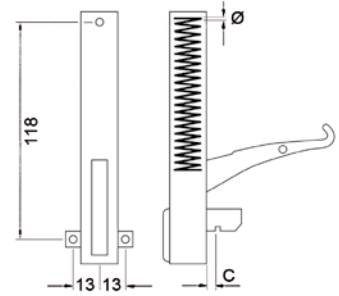

fig.	part no.	mounting ear	ø(mm)	C (mm)	counterpart	passend for	equiv. no.	fig.	part no.	mounting ear	ø(mm)	C (mm)	counterpart	suitable for	equiv. no.
1	700016	left	3.5	11	B	Foem Mareno	05150024501 1031105900	2	700015	right	3.5	11	B	Foem Mareno	05150024401 1031105800



no.	part no.	mounting ear	ø(mm)	C (mm)	counterpart	suitable for	equiv. no.
1	690030	left/right	3.5	11	B	Lotus Mareno Modular	531007100 1034400400 68402200

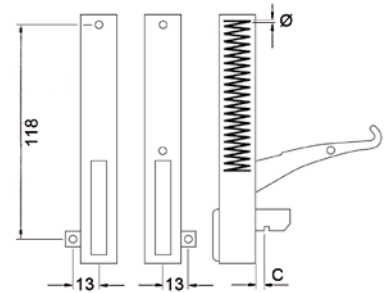

fig.	part no.	mounting ear	ø(mm)	C (mm)	counterpart	suitable for	equiv. no.	fig.	part no.	mounting ear	ø(mm)	C (mm)	counterpart	suitable for	equiv. no.
1	690035	left	3.5	11	Lotus	B	531005300	2	690034	right	3.5	11	B	Lotus	531007400

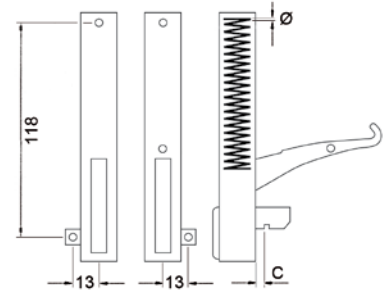
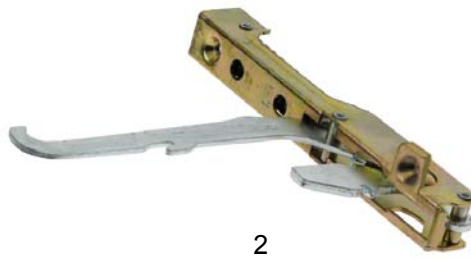
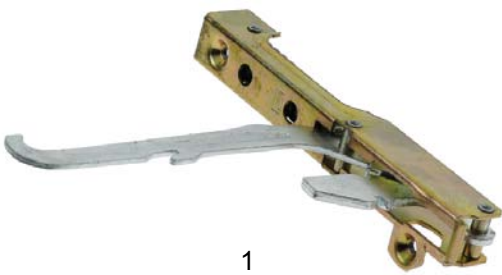

fig.	part no.	mounting ear	ø(mm)	C (mm)	counterpart	suitable for	equiv. no.	fig.	part no.	mounting ear	ø(mm)	C (mm)	counterpart	suitable for	equiv. no.
1	700554	left	3.5	7	C	Küppersbusch	133764	2	700553	right	3.5	7	C	Küppersbusch	133765

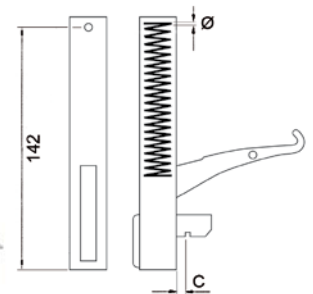

fig.	part no.	mounting ear	ø(mm)	C (mm)	counterpart	suitable for	equiv. no.	fig.	part no.	mounting ear	ø(mm)	C (mm)	counterpart	suitable for	equiv. no.
1	700000	left/right	3.5	12	C, Q, R	Tecnoeka	1980859512	3	700459	left/right	3.5	7	C	Olis Roller Grill	A035980 B09005
2	700433	left/right	4	12	C, Q, R	Tecnoeka	9981619512								



1



2



3

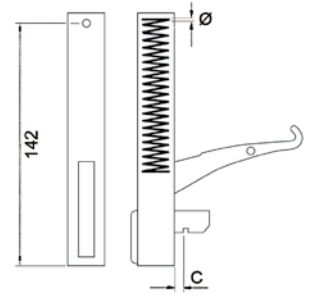

fig.	part no.	mounting ear	ø(mm)	C (mm)	counterpart	passend for	equiv. no.
1	700624	left/right	3.2	13	F, G	Smeg	931330461
2	700672	left/right	4	13	G, K, P	Smeg	931330806

fig.	part no.	mounting ear	ø(mm)	C (mm)	counterpart	suitable for	equiv. no.
3	700671	left/right	4	11	G, K, P	Smeg	931330656



1



2

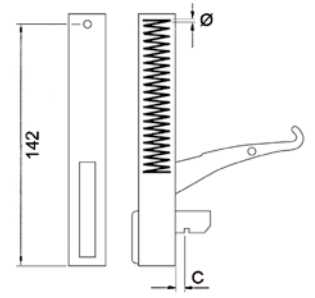

fig.	part no.	mounting ear	ø(mm)	C (mm)	counterpart	passend for	equiv. no.
1	700623	left/right	3	14	L	GAM Smeg Piron	RFORM17 931330805 7424000003

fig.	part no.	mounting ear	ø(mm)	C (mm)	counterpart	suitable for	equiv. no.
2	700627	left/right	3.5	14	L	Smeg Smeg	931330887 931331154



1



2

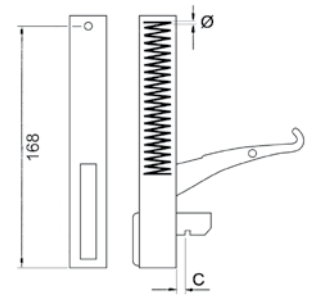
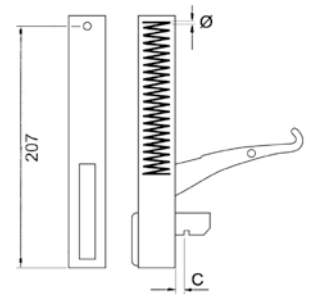
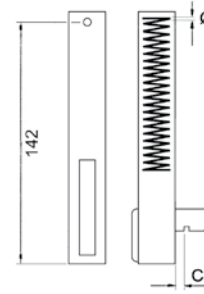

fig.	part no.	mounting ear	ø(mm)	C (mm)	counterpart	suitable for	equiv. no.
1	700738	left/right	4	11	M	RM Gastro	408790300

fig.	part no.	mounting ear	ø(mm)	C (mm)	counterpart	suitable for	equiv. no.
2	700456	left/right	3.5	11	S	Zanussi Zanussi	056339 058933



no.	part no.	mounting ear	ø(mm)	C (mm)	counterpart	suitable for	equiv. no.
1	690037	left/right	4.5	13	T	Lotus	531008200



no.	part no.	mounting ear	ø(mm)	C (mm)	counterpart	suitable for	equiv. no.
1	700390	left/right	3	12	-	Foinox	15062

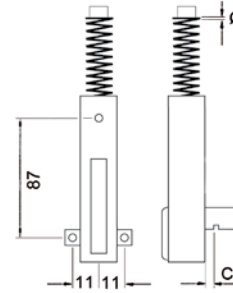

no.	part no.	Qty	mounting ear	ø(mm)	C (mm)	counterpart	suitable for	equiv. no.
1	700760	1 pair	left/right	2.8	12	-	Unox Unox Unox	KCR020 CR1065A0 CR1070A0

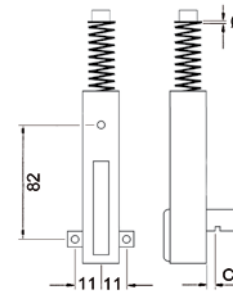

no.	part no.	Qty	mounting ear	ø(mm)	C (mm)	counterpart	suitable for	equiv. no.
1	700759	1 pair	left/right	3	9	-	Unox Unox Unox Unox	KCR012 KCR013 CR1000A0 CR1025A0

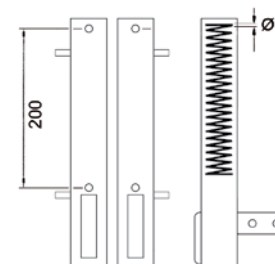

no.	part no.	Qty	mounting ear	ø(mm)	C (mm)	counterpart	suitable for	equiv. no.
1	690560	1 pair	left/right	3.6	-	-	Gico	A00006



no.	part no.	mounting ear	ø(mm)	C (mm)	counterpart	suitable for	equiv. no.
1	700704	left/right	2	5	Angelo Po	36M0190	531008200

oven hinges

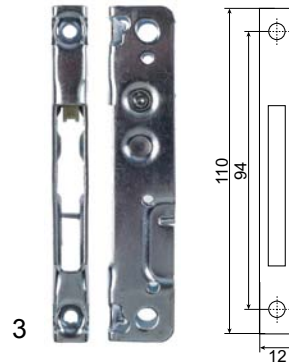
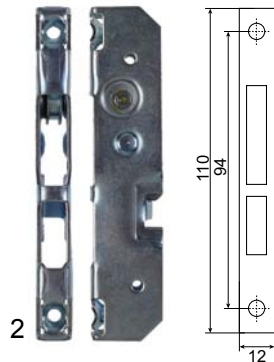
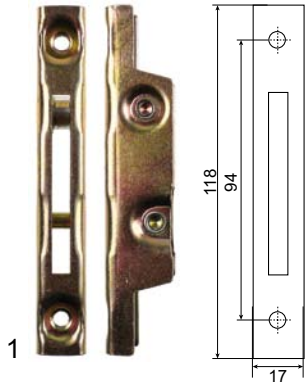

fig.	Bestell.no.	type	A (mm)	suitable for	equiv. no.
1	700001	A		universal	--
2	700003	B		universal	--

fig.	part no.	type	A (mm)	suitable for	equiv. no.
3	693045	C		universal	--

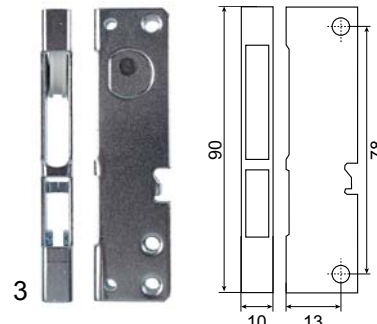
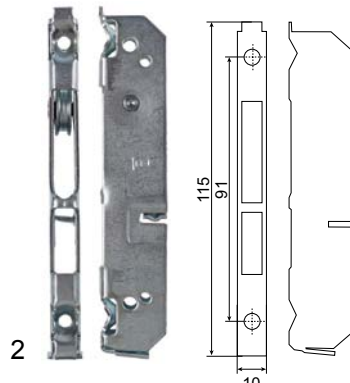
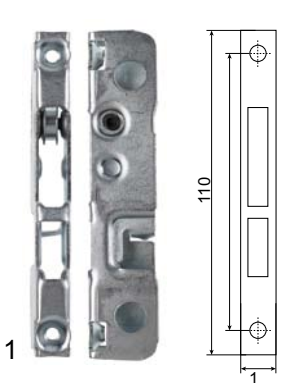

fig.	Bestell.no.	type	A (mm)	suitable for	equiv. no.
1	690039	D		Lotus	531012400
2	700739	M		RM Gastro	408790310

fig.	part no.	type	A (mm)	suitable for	equiv. no.
3	700457	S		Zanussi	058934 056439



fig.	Bestell.no.	mounting position	type	suitable for	equiv. no.
1	700633	left	G	Smeg	685970012
2	700625	right	F	Smeg	685970011
3	700677	left	H	Smeg	685970027

fig.	part no.	mounting position	type	suitable for	equiv. no.
4	700678	right	I	Smeg	685970026
5	700681	right	K	Smeg Smeg	685970043 685970024

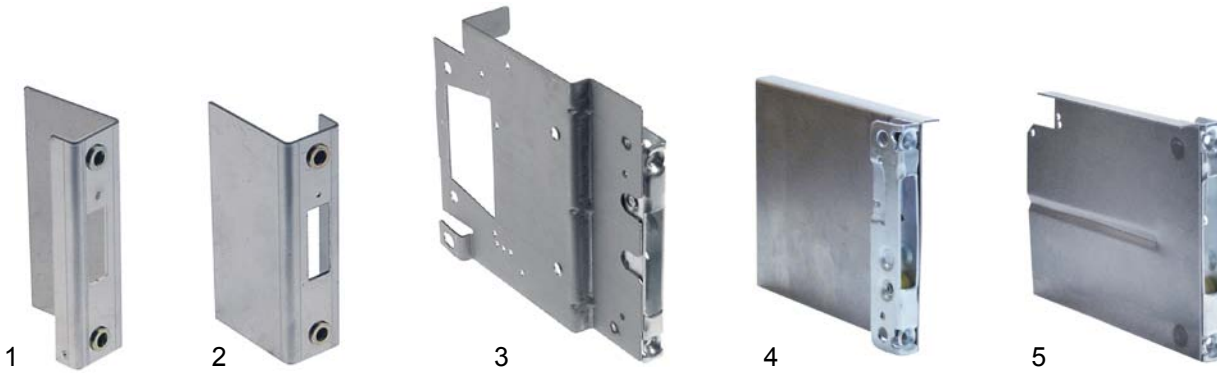

fig.	Bestell.no.	mounting position	type	suitable for	equiv. no.
1	700628	right	L	Smeg	698290716
2	700629	left	L	Smeg	698290717
3	693931	right	P	Smeg	685970017 685970017

fig.	part no.	mounting position	type	suitable for	equiv. no.
4	700706	right	Q	Tecnoeka	1981599512
5	700707	left	R	Tecnoeka	1981589512

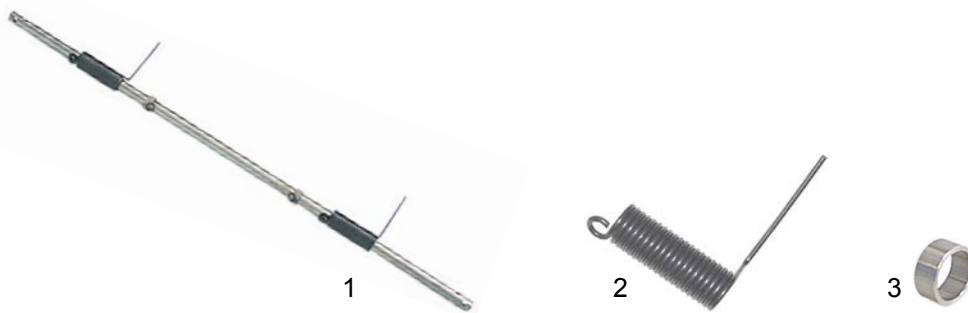

fig.	Bestell.no.	description	suitable for	equiv. no.
1	690369	hinge	Baumeister	-
2	690029	spring	Baumeiser	-

fig.	part no.	description	suitable for	equiv. no.
3	690348	spacer ring	Baumeister	-



fig.	Bestell.no.	description	suitable for	equiv. no.
1	700400	hinge right	Ambach	3512016349
2	700401	hinge left	Ambach	3512016350

fig.	part no.	description	suitable for	equiv. no.
3	700402	spacer ring	Ambach	3031414396

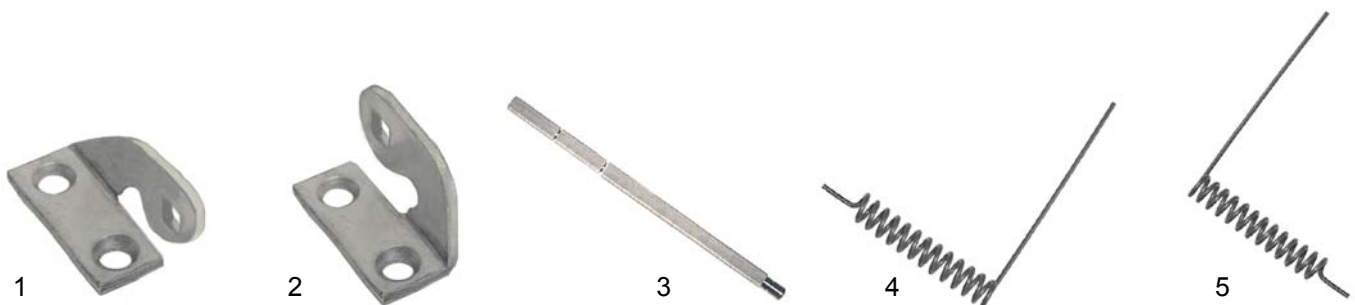

fig.	Bestell.no.	description	suitable for	equiv. no.
1	700029	hinge right	Juno series 71/72 static	820596
2	700094	hinge left	Juno series 71/72 static	821830
3	700024	hinge rod	Juno series 71/72 static	234612

fig.	part no.	description	suitable for	equiv. no.
4	700022	spring right	Juno series 71/72 static	245663
5	700023	spring left	Juno series 71/72 static	245664

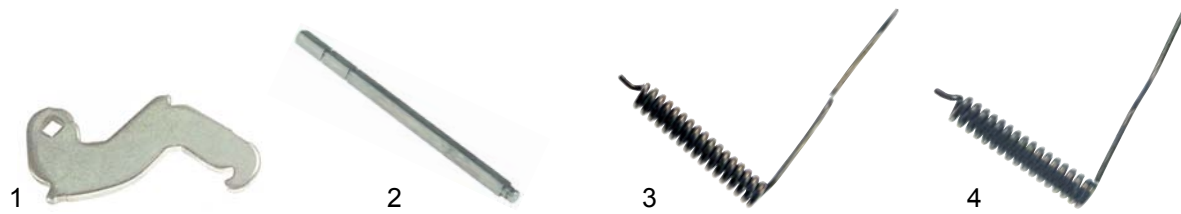

fig.	Bestell.no.	description	suitable for	equiv. no.
1	700436	hinge right/left	Juno series 71 umluft	828931
2	693742	hinge rod	Juno series 71 umluft	224242

fig.	part no.	description	suitable for	equiv. no.
3	700426	spring right	Juno series 71 umluft	279830
4	700427	spring left	Juno series 71 umluft	279829



fig.	Bestell.no.	description	suitable for	equiv. no.
1	700029	hinge right	Juno series 74/75/85/90	820596
2	700094	hinge left	Juno series 74/75/85/90	821830
3	700028	hinge rod	Juno series 74/75/85/90	234607

fig.	part no.	description	suitable for	equiv. no.
4	700026	spring right	Juno series 74/75/85/90	279449
5	700027	spring left	Juno series 74/75/85/90	279450



fig.	Bestell.no.	description	suitable for	equiv. no.
1	700514	spring	MKN	216079
2	700040	spring	Blumauer	-

fig.	part no.	description	suitable for	equiv. no.
3	700096	spring	Tornatti	TO515002
4	700499	spring	Tornatti	-

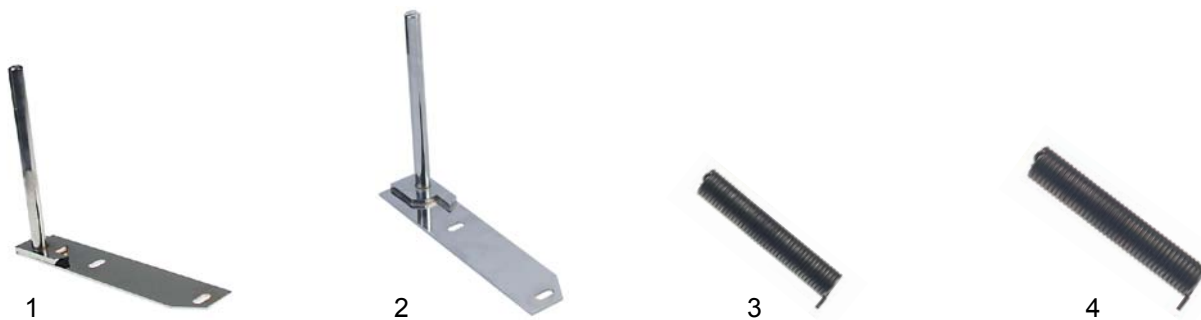

fig.	Bestell.no.	description	suitable for	equiv. no.
1	693384	hinge right	Zanolli	SUPP0207
2	693385	hinge left	Zanolli	SUPP0139

fig.	part no.	description	suitable for	equiv. no.
3	693386	spring right	Zanolli	SPR10010
4	693387	spring left	Zanolli	SPR10009



fig.	Bestell.no.	description	suitable for	equiv. no.
1	514073	spring	Cuppone	ADME01203
2	700492	spring 127mm	Moretti	72500670
3	700493	spring 155mm	Moretti	72500660

fig.	part no.	description	suitable for	equiv. no.
4	700159	spring	Pizza Group	4000530
5	697349	spring	Pizza Group	PF08650